

**Altrive
Red Deer**

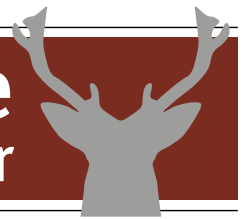

performance recorded since 1985

Geoff Elder

P 03 202 5809 M 0274 365214

www.altrivereddeer.co.nz

2016 Sales Catalogue

5th on-farm DEER SALE

Thursday 14th January 2016 5.00pm

sons of Everest – the super sire



188-12 – x Everest
10.35kg SA National 3yr champion



105-12 – x Everest
*8.2kg SA 2nd place National 3yr
Lot 1 2016*



53-07 – x Everest
6.2kg 2yr National Champion



194-09 – x Everest
7.55kg National Champion



77-07 – x Everest
8.2kg 4yr 2nd place Nationals



95-11 – x Everest
7kg 2yr 3rd place Nationals



welcome

Welcome to our fifth on-farm deer auction.

Lynette and I took over the Family Sheep Farm in 1979 and started performance recording 200 of our commercial ewes which resulted in us selling rams and starting a registered Romney stud as well.

In 1985 we brought our first hinds and so naturally we recorded them too. After five years we were running approximately 200 share farmed hinds, all recorded, as well as our own small herd of around 50 hinds. During the early years we selected on growth rates and then moved on the velvet as well, keeping 2yr old stags that cut a minimum of 1.3kg.

Since 2008 our 2yr old keepers have averaged over 4kg.

This year's 3yr sale average is 6.70kg and the heads are very tidy.

We will also be offering a minimum of 60 2yr velvetting stags.

Photos of velvetting stags should be on our website www.altrivereddeer.co.nz by the New Year.

After the sale you are most welcome to stay for a BBQ and Refreshments.

Geoff Elder

Altrive, 25 Waipounamu Road, RD6,
Gore, Southland

Phone 03 202 5809 Mobile 0274 365214

comp results

A selection of our competition results:

2015

1st and 2nd Place

National 3yr Velvet Competition

2012

1st Place Open

National Velvet Competition

People's Choice

National Velvet Competition

Grand Champion

National Velvet Competition

1st Place

National 3yr Velvet Competition

2nd Place

National 5yr Velvet Competition

2011

2nd Place

National 4yr Velvet Competition

3rd Place

National 5yr Velvet Competition

4th Place

National 5yr Velvet Competition

2010

1st Place

National 2yr Velvet Competition

1st Place

National 4yr Velvet Competition

2009

1st Place

National 3yr Velvet Competition

3rd Place

National 3yr Velvet Competition

2nd Place

National 2yr Velvet Competition

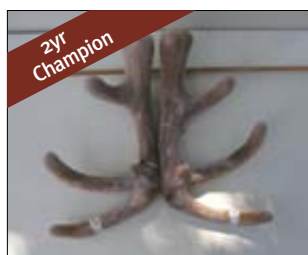

Altrive 53-07
6.2kg SA 2yr Sold Tower Farms



Altrive 194-09
7.55kg SA 3yr



Altrive 81-06
8.45kg SA 4yr

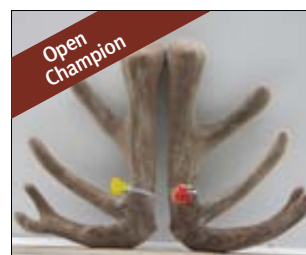

Zama 74-06
11.3kg SA 6yr



David 11kg SA



Altrive 105-12
8.5kg SA 3yr



Altrive 188-12
10.35kg SA 3yr



Altrive 77-07
8.25kg SA 4yr

statistics

Altrive herd statistics

Herd makeup

Approx 300 Hinds. All Stag fawns kept until 2yr olds

Average Velvet Weights

2013 mixed age velvet stags aged 4yr to 11yr averaged **7.25kg**.

Year	2015	2014	2013	2012	2011	2010	2009	2008	2007	2006
2yr Average		3.8kg	3.8kg	3.68kg	3.43kg	3.36kg	3.27kg	3.12kg	3.12kg	2.94kg
2yr Keeper Av		4.48kg	4.3kg	4.36kg	4.14kg	4.20kg	4.25kg	4.05kg	3.83kg	3.60kg
3yr	6.2kg	5.95kg	5.5kg	5.5kg	5.25kg	5.90kg	5.20kg	4.70kg	4.86kg	4.70kg

Approx 55 retained

Approx 35 retained

Since 2011 we have been keeping a higher number of stags. Although this has lowered the comparative average, the herd continues to go from strength to strength.

2010 Statistics

149 mixed age 4yr and older Stags

19 not suitable for SS grade, double trez or bulbs not good enough average 6.5kg SA

130 stags SS grade average weight 8.6kg

about the sale

5th on-farm deer sale Thursday 14th January 2016 5.00pm



188-12 @ 3yr – x Everest

This stag was cut 2 days after this photograph – 10.35kg SA

25 **3yr and one 2yr Sire Stags** plus approx 70 2yr old **Velveting Stags** and 50 **Yearling Hinds** with a lot by **Everest and Zama** due to our **AI and embryo programs**

Sale offering progeny of:

- **Altrive 81-06**
11.80kg SA @ 7yr
- **Everest 341-04**
12.25kg SA @ 9yr
- **Zama 74-06**
7.60kg SA 3yr Champion
11.30kg Open Champion
- **FOV 191-09**
10.30kg SS
- **Altrive 123-04**
502 IOA @ 4yr
- **Altrive 77-07**
8.25kg 2nd National 4yr
and 10kg @ 6yr
- **765-10**
8.10kg SA @ 3yr
- **95-11**
8.00kg SA @ 3yr

See sire pages inside for more info.



legal

Conditions of Sale

1. The Sale will be conducted by PGG Wrightson with the conditions of sale as set down by the Stock and Stations Agents Association, a copy of which is exhibited in the office on sale day.
2. Each lot becomes the purchaser's property and risk at fall of the hammer.
3. Warranties and Insurance are covered under separate headings.
4. Terms are strictly cash unless prior arrangements are made with the auctioneers. Accounts not paid within 14 days of sale shall bear interest, at current rate per annum from the date of sale.
5. The sale is conducted exclusive of GST.
6. A buyers commission of 4% is payable to non-participating companies and recognised independent agents introducing and accompanying purchasers to the sale providing prior arrangements [No later than 24hrs prior to sale] are made with PGG Wrightson.
7. Intending purchasers are required to register with the auctioneers prior to the commencement of the sale.
8. No Animals, embryos or semen sold by Altrive, or their germplasm, any subsequent progeny or germplasm, including the semen and germplasm of that progeny may be supplied to a third party without the written permission of the stud.
9. This condition does not affect normal commercial deer farming or stud farming or the normal sales of semen or embryos as it only applies to entities with the primary function of commercial semen/germplasm activities.
10. It is a condition of sale of any animals, embryos, germplasm or semen sold by Altrive that the purchaser agrees to include the following clause as a condition of any subsequent sale or gift of any animal, embryo, semen, germplasm or subsequent progeny or germplasm to a third party- "the purchaser acknowledges that it will not supply any animals, embryos, semen or germplasm to any commercial semen/germplasm marketing or sales entity, and will ensure that this clause is inserted as a condition of any sale or gift of any animals, embryos, semen or germplasm."

Disclaimer

All details and descriptions as to stock referred to in the catalogue have been supplied to PGG Wrightsons by the vendor and have not been independently verified by PGG Wrightson. PGG Wrightson, its employees and agents make no representations or warranties or acknowledgment of any kind whatsoever in relation to any part of this catalogue [including but not limited to accuracy or completeness of details and descriptions of stock {and other contents}]

Purchasers, advisers and all other persons viewing or dealing with the stock must make their own assessment on the stock and the information in this catalogue.

PGG Wrightson, its employees and agents are not responsible or liable in any way whatsoever, weather in contract, tort [including negligence], or otherwise, to any person for any loss or any damage whatsoever arising directly or indirectly from any information or misrepresentation included or omitted from this catalogue.

Velvet will be on display on sale day and will remain the property of the vendor.

Testing

Altrive is TB accredited C10 and all Sires are tested Johnes negative.

Our whole herd is DNA tested.

finding altrive

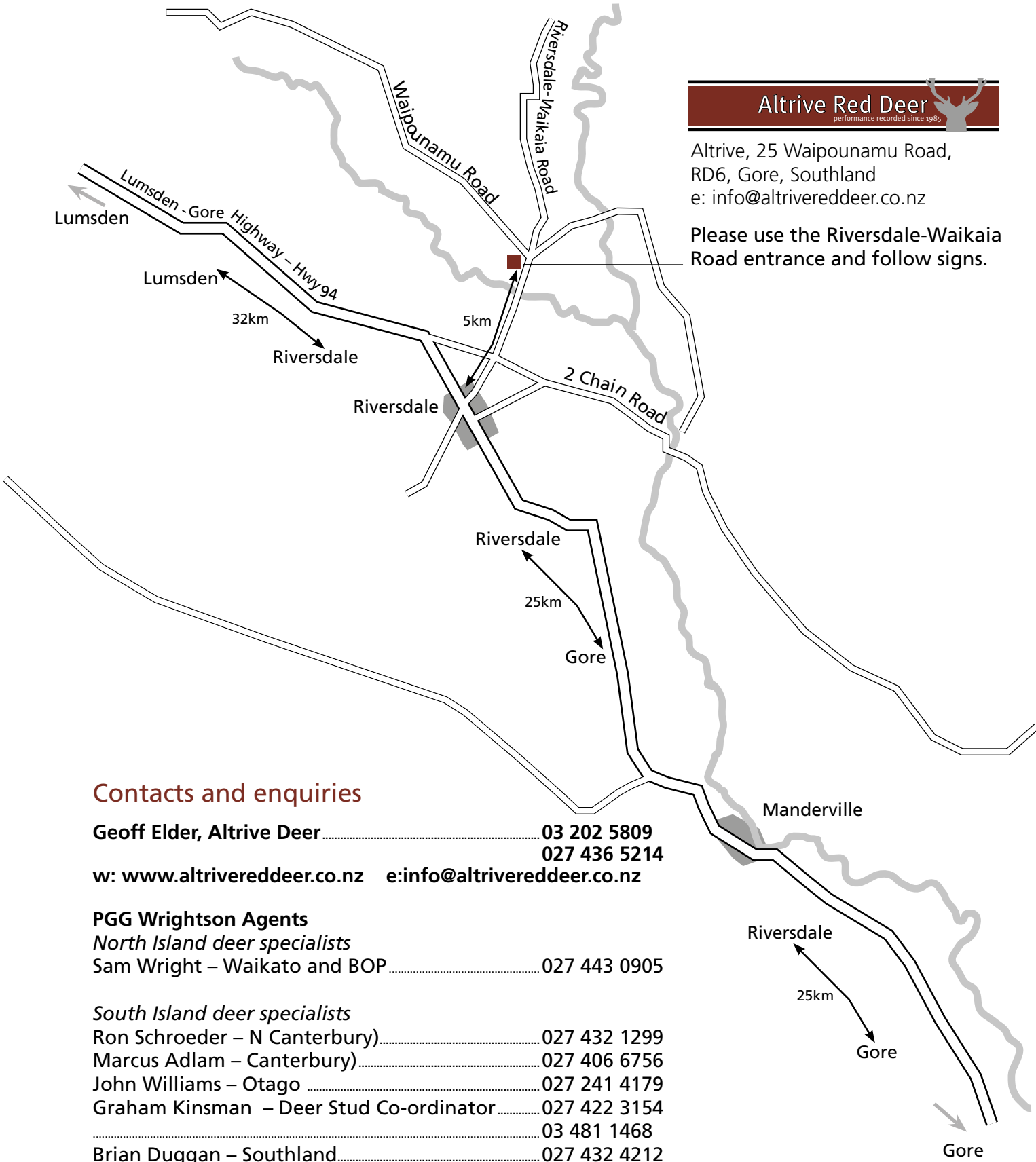

Altrive, 25 Waipounamu Road,
RD6, Gore, Southland
e: info@altrivereddeer.co.nz

Please use the Riversdale-Waikaia Road entrance and follow signs.

Contacts and enquiries

Geoff Elder, Altrive Deer 03 202 5809
027 436 5214
w: www.altrivereddeer.co.nz e: info@altrivereddeer.co.nz

PGG Wrightson Agents
North Island deer specialists
Sam Wright – Waikato and BOP 027 443 0905

South Island deer specialists
Ron Schroeder – N Canterbury) 027 432 1299
Marcus Adlam – Canterbury) 027 406 6756
John Williams – Otago 027 241 4179
Graham Kinsman – Deer Stud Co-ordinator 027 422 3154
..... 03 481 1468
Brian Duggan – Southland 027 432 4212

Auctioneers
John Duffy – Central Otago 027 240 3841
Neville Clark 027 598 6537



sire stags at altrive

Everest 341-04

Everest breeds very heavy tidy velvet that is proven by breeding a 2yr, and two 3yr old National Velvet champions here at Altrive, plus two 2nd and one 3rd place.

Purchased for \$50,000 with Brock Deer.

From his 1st drop in 2007 Everest had 17 stag fawns:

- 9 sold as 2yr velvet stags
- 1 sold as 2yr sire stags
- 7 kept to 3yr sale



9.84kg 5yr. 4th 5yr 2009

Progeny of Everest 341-04



188-12 10.35kg @ 3yr 105-12 8.2kg 3yr 53-07 6.2kg 2yr



194-09 7.55kg Champ 77-07 8.24kg sa 4yr 95-11 7kg 2yr



76-07 6.6kg sa 3yr 61-07 6.0kg sa 3yr 59-07 5.9kg sa 3yr



123-07 6.04kg sa 3yr 194-09 5.0kg 2yr 91-09 4.5kg 2yr



84-09 5.2kg 2yr 103-11 7.25kg @ 3yr 65-11 6.3kg @ 3yr



23-12 4.6kg 2yr

Tag# / Name	Everest 341-04
Spiker	
Velvet 2 year	
Velvet 3 year	7.6kg
Velvet 5 year	9.8kg
Velvet 6 year	10.65kg
Velvet 9 year	12.25kg
Notes	Breeding very correct velvet. Everest Sons from first mating: ALT 53-07 6.2kg SA @2yr Sold \$17,000 Tower farms 2yr Champion Won North Island 3yr ALT 61-07 6.0kg SA @ 3yr Sold \$10,500 ALT 76-07 6.6kg SA @ 3yr Sold \$10,500 ALT 59-07 5.9kg SA @ 3yr Sold \$6500 ALT 77-07 7.46kg SA Retained in stud 8.24kg 4yr 2nd place Nationals

Pedigree

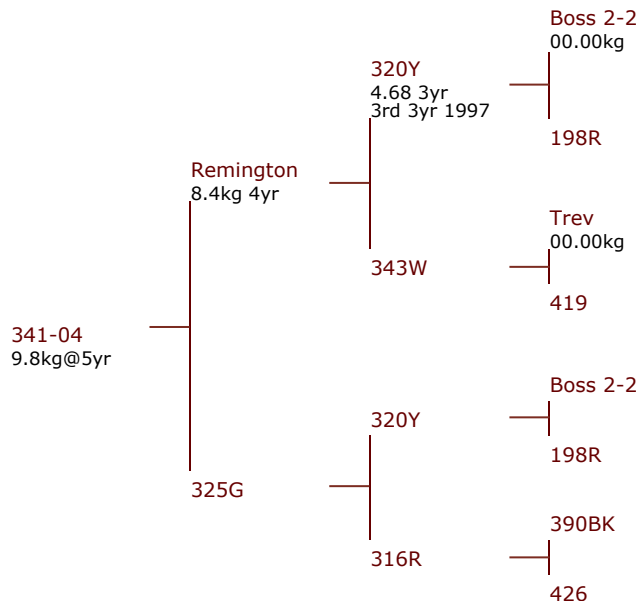

Zama 74-06

Zama was purchased for \$30,000. He is jointly owned with Brock Deer. (Now deceased.)



74-06 11.3kg Winner of National Open, Grand Champion and People's Choice, 2012 at 6yr

Tag# / Name	74-06 / Zama
Weaner weight	
Velvet 3 year	7.66kg 3 yr Won National 3 yr velvet competition
Velvet 4 year	Grown out 4 yr 422 IOA
Velvet 5 year	Grown out 5 yr 478 IOA
Velvet 6 year	11.3kg Winner of National Open, Grand Champion and People's Choice, 2012
Velvet 7 year	12.25kg
Notes	First 2 yr sons born 2009 averaged 4kg



2009 Nationals



2 yr head 30 point ha



Zama - growing out 2011

Pedigree

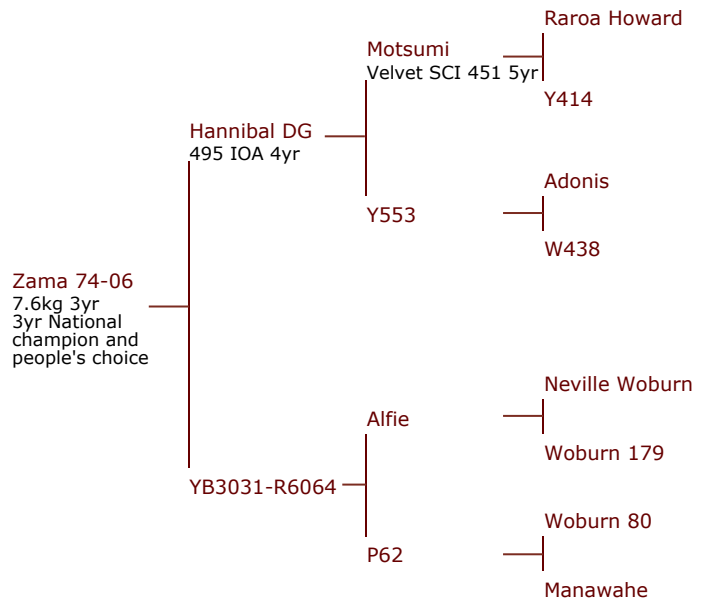

See next page for progeny of Zama



Progeny of Zama 74-06



142-09 4.65kg 2yr



Victrix in velvet @ 6yr



Victrix as trophy @ 6yr

Victrix (142-09) was sold to Arawata stud at our 2012 sale.



34-12 7.35kg @3yr



46-12 7.2kg 3yr



171-11 6.65kg 3yr



26-10 6.2kg 3yr



21-11 @ 2yr



111-09 5.05kg @ 2yr



89-13 2yr Cut 8.3kg



38-13 6.45kg @ 2yr



111-09



111-09 4.6kg 2yr



76-09 6kg 2yr



10-09 4.35kg 2yr



101-09 4.65kg 2yr



106-10 4.6kg 2yr



108-10 5.15kg 2yr



171-11 6.65kg 3yr



199-11 7.65kg 3yr



159-11 6.35kg 3yr



173-11 6.0kg 3yr



167-11 6.5kg 3yr



18-12 4.85kg 2yr



34-12 5kg 2yr



173-12 5kg 2yr

David 230-98

David cut 11kg @9yr and sired 123-04 502 IOA @4yr.

Also sired 186-04 sold as sire to Alan Stewart \$20000.

Has left 3yr olds cutting up to 8kg of velvet.



Full head of David x Thomas Albert

Tag# / Name	230-98 / David
Weaner weight	
Velvet 2 year	
Velvet 11 year	11kg sa
Notes	



David - 11kg 6th Open 2009

Pedigree

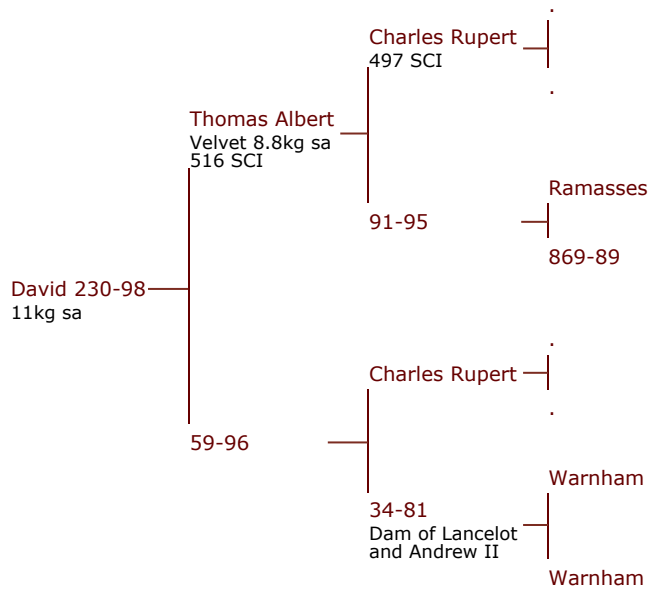

Progeny of David 230-98



186-04

David + Son 123-04



113-07 tw 6.52kg sa 3yr

99-10 5.7kg 2yr



99-10 Spiker

99-10 Spiker

99-10 Spiker 6.1kg



133-11 6.15kg 3yr

46-11 9.1kg 3yr

149-10 6.4kg @ 3yr



Altrive 81-06



Tag# / Name	81-06
Weaner weight	79kg
Velvet 2 year	5.7kg 2nd National 2yr velvet Competition
Velvet 3 year	7.3kg
Velvet 4 year	8.45 kg 4 yr 4 yr National velvet champ First 2 yr sons velveted Dec 2011
Velvet 5 year	
Velvet 6 year	11.0kg
Velvet 7 year	11.8kg
Velvet 9 year	17.2kg
Notes	

81-06 8.45kg sa 4yr 2nd National 2yr competition
Winner National 4yr Competition



103-08 5.6kg sa 2yr.
Full brother of 81-06

Progeny of 81-06



229-10 4.65kg 2yr 229-10 7.6kg 3yr 262-10 4.8kg 2yr



020-11 6.7kg 3yr 219-11 6.5kg 3yr 222-10 9.1kg 4yr



294-12 5.45kg SA 2yr 20-11 6.7kg 3yr

Pedigree

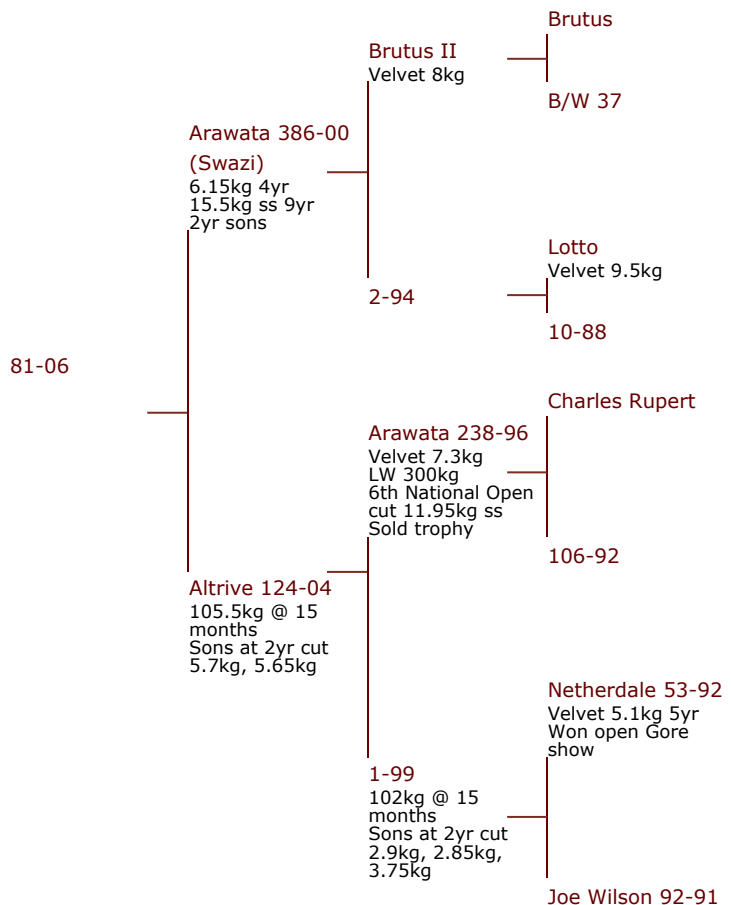

Altrive 77-07

Sold to Regan Blair for \$15,000 to make way for Everest son 95-11 7kg 2yr.



Altrive 77-07 - 8.24kg sa 4yr - 2nd place Nationals 2011 x Everest.
10kg @ 6 yr

Tag# / Name	77-07
Weaner weight	
Velvet 2 year	4.35kg
Velvet 3 year	7.46kg
Velvet 6 year	10.00kg
Notes	Very strong Dam line for velvet. Check out other Everest sons on Everest page.

Progeny of 77-07



255-11 5.6kg @ 3yr 150-12 7.20g @ 3yr 169-12 6.40kg @ 3yr



277-12 6.8kg @ 3yr 150-12 5.45kg @ 2yr 77-11 6.7kg @ 3yr

Pedigree

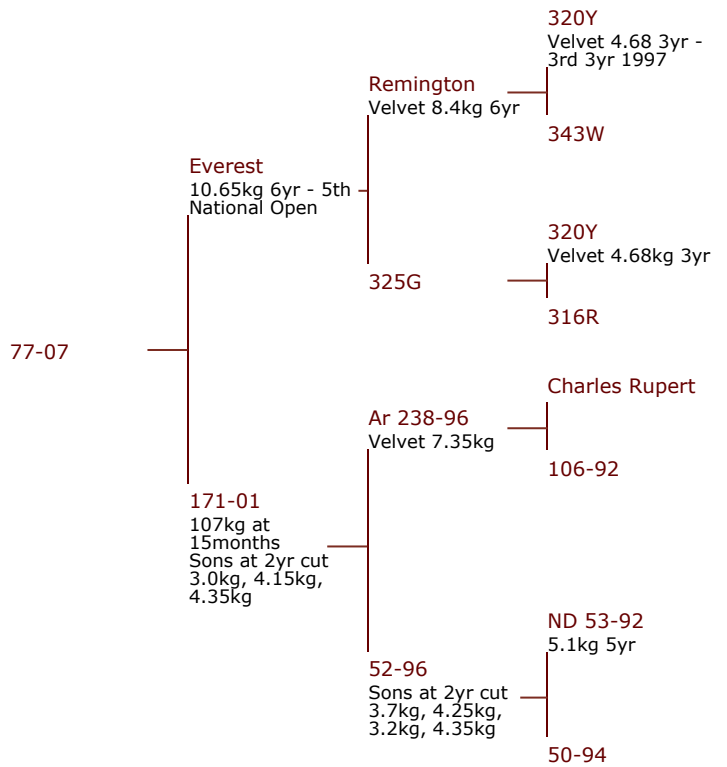



Arawata Swazi 386-00

Purchased for \$30,000 with Brock Deer and E Tayles

Swazi's complete drop of 2 yr sons had an average weight of 3.51kg in 2007 and 3.72kg in 2008.



Altrive sire stag - Arawata Swazi 386-00. 14.3kg SS 8yr.



5.2kg 3yr

Progeny of 386-00



81-06 8.45kg sa 4yr 103-08 5.65kg sa 2yr 20-06 7.3kg 3yr

Tag# / Name	386-00 Arawata Swazi
Weaner weight	
Velvet 3 year	5.2kg
Velvet 4 year	6.0kg
Velvet 9 year	15.5kg SS
Notes	Very good Sire that mated well with all Dam lines

Pedigree

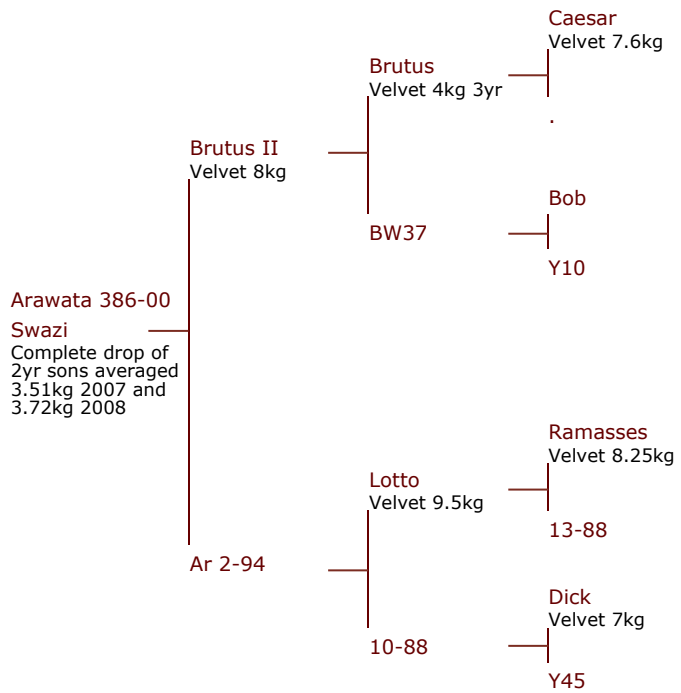

Altrive 123-04

Trophy 2yr son sold for \$12000 and breeds good velvet with 3yr sons over 7kg.

4.2 kg SA 2 yr 3rd Southland 2 yr competition

5.2 kg SA 3 yr

Scored 502 IOA @ 4yr and breeds very good velvet and trophy heads as can be seen in the progeny photos below.



123-04



4.2 kg SA 2 yr

Progeny of 123-04



196-07 7.3kg sa 3yr 162-07 5.95kg sa 3yr 242-09 Spiker



56-10 4.6kg 2yr 171-10 4.45kg 2yr 41-10 Trophy@2yr



243-09 10.55kg 243-09 10.55kg 243-09 6.55kg cut 1.11

Tag# / Name	123-04 David Son (deceased)
Weaner weight	62kg
2 year	200kg
Velvet weight 2yr	4.2kg
Notes	Now deceased

Pedigree

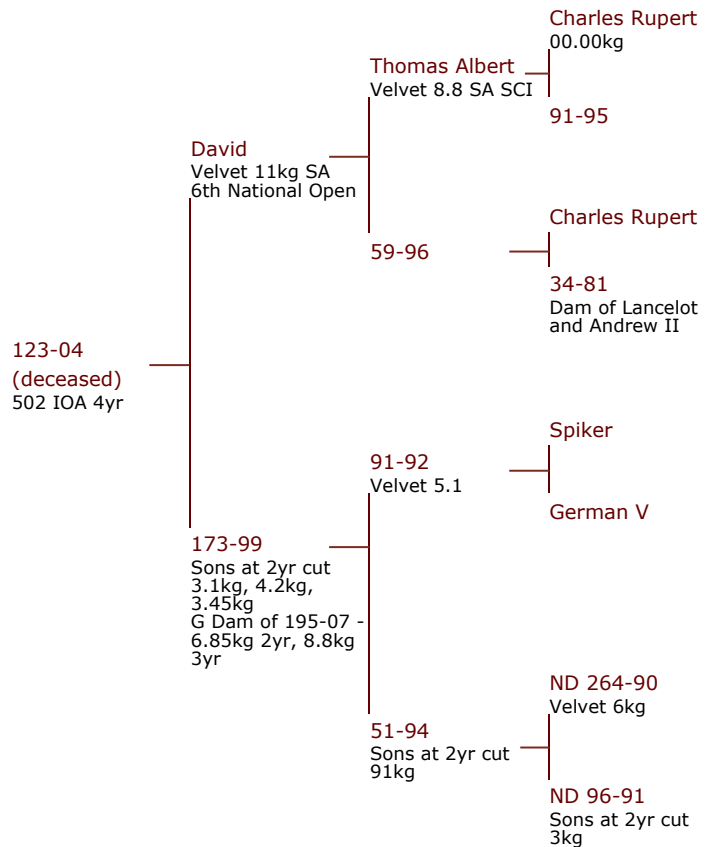



Arawata 238-96 - Altrive sire stag

238-96 cut 7.35kg 7yr and bred very well for us with a lot of his sons sold as trophy stags and his daughters breed well.

Pedigree

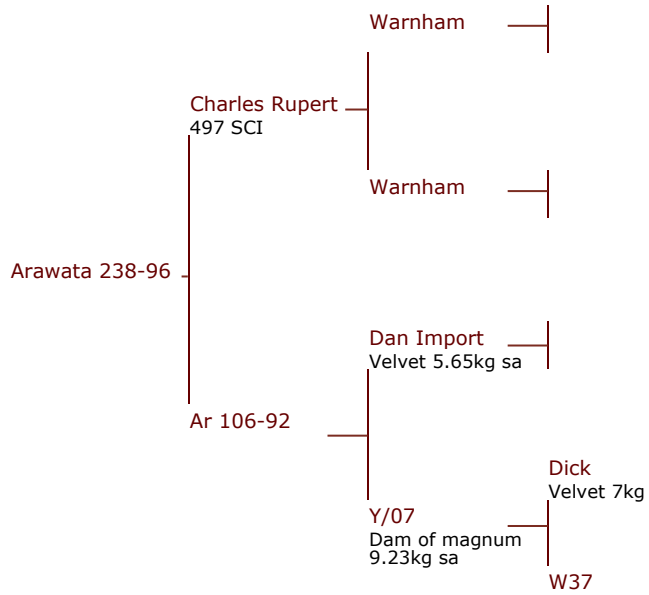

7.35kg SA 7 yr 11.95kg SS 8 yr 300kg Live weight



7.35kg 7yr (6th Nat Open)

Progeny of 238-96



78-02 10kg ss 6yr 78-02 485 sci 78-02 7.65 5yr 47-04 10.2kg ss 261-03 10.25kg ss 136-03 6.8kg 4yr 4 Sons of 238-96

Altrive 78-02



7.65 5yr



10kg ss 6yr / 11.65kg ss 7yr



Full head 78-02 Dec 2010
485 SCI

Progeny of 78-02



82-06 7.36kg 3yr



224-10 4.55kg 2yr

Tag# / Name	78-02
Weaner weight	
Velvet 3 year	5.15kg SA
Velvet 4 year	6.5kg SA
Velvet 5 year	7.65kg SA
Velvet 9 year	11.65kg SA
Notes	Son of 238-96

Pedigree

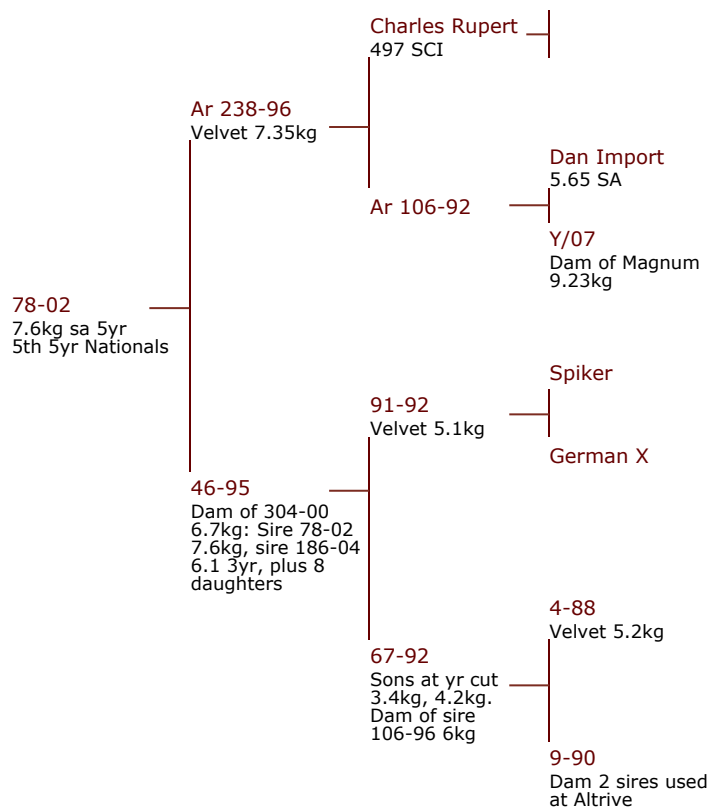



Altrive 186-04



Altrive 186-04 Sire Stag

Progeny of 186-04



195-07 8.8kg sa 3yr

Tag# / Name	186-04
Weaner weight	
Velvet 2 year	4.85kg SA
Velvet 3 year	6.1kg SA
Velvet 4 year	10kg SS
Notes	Only used as two year old

Pedigree

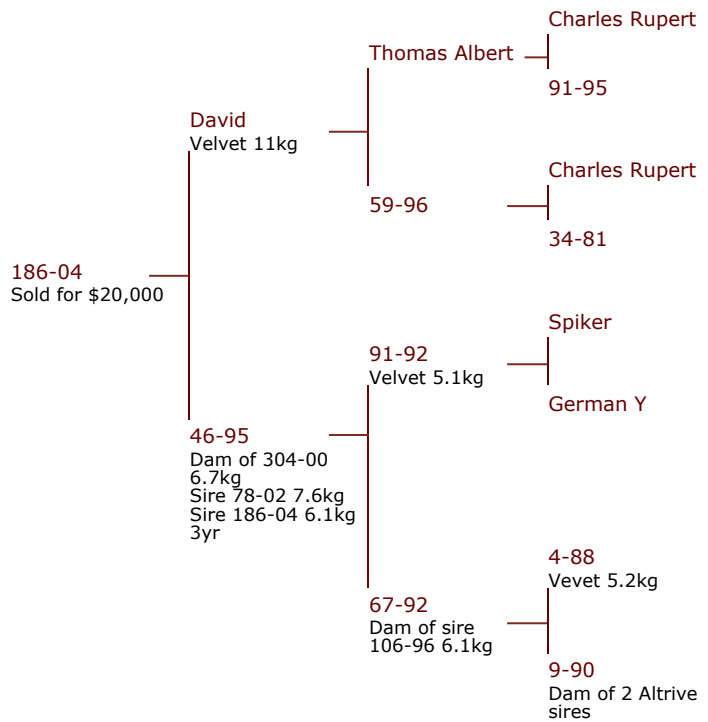

Gloriavale 352-08

Spiker 20 point 300plus IOA. Only used as a 2yr old.



Photo of 352-08 10.8kg @ 7yr

Tag# / Name	352-08
Weaner weight	
2 year live weight	174kg
Velvet 2 year	Full head
Notes	

Progeny of 352-08



242-11 6.7kg 3yr

258-11 8.5kg 3yr

Pedigree

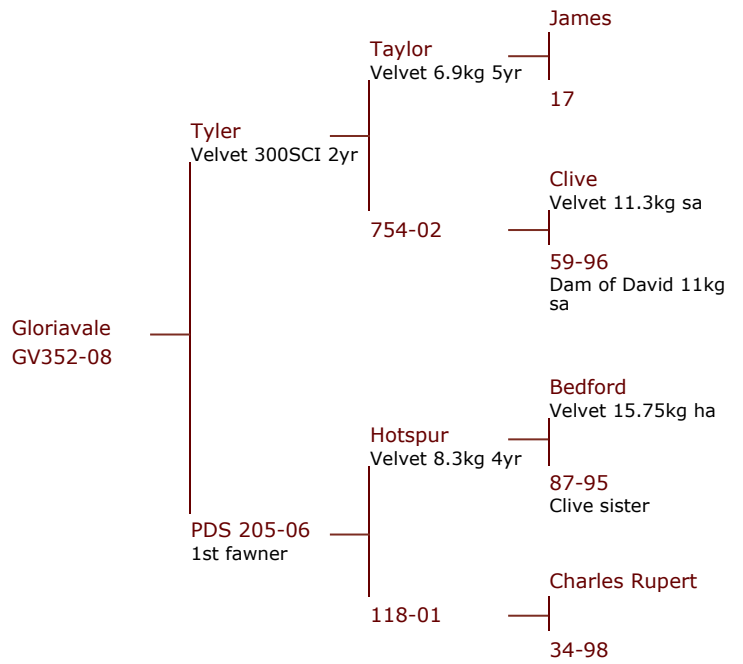



FOV 191-09

This stag was purchased in 2012 as a 2yr old from Foveran. An Amadeus son with very correct head weighing 10kg HA. Bought to add trophy tops to our stags.

3yr head looking very good.



191-09 grown out @ 3 years

Tag# / Name	FOV 191-09
Spiker	
Velvet 2 year	10kg HA
Velvet 3 year	
Velvet 5 year	
Velvet 6 year	
Notes	Weaned weight 66kg, 200kg @ 2yr. Grown out at 3 yr.

Progeny of FOV 191-09



216-12 7.4kg @ 3yr



219-12 6.1kg @ 3yr



249-12 6.05kg @ 3yr



216-12 5.75kg @ 2yr

Pedigree

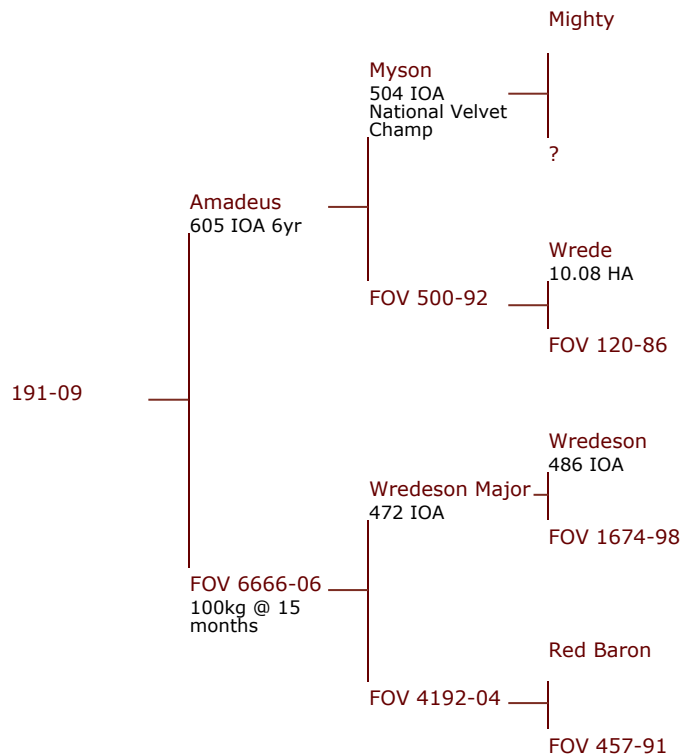

Altrive 95-11

First two year progeny to be velveted in 2016.



95-11 7.0kg @ 2yr



95-11 8.6kg @ 3yr

Tag# / Name	Altrive 95-11
Weaner weight	
Velvet 2 year	7.0kg
Velvet 3 year	8.6kg
Velvet 4 year	
Velvet 5 year	
Velvet 6 year	
Velvet 7 year	
Notes	

Pedigree

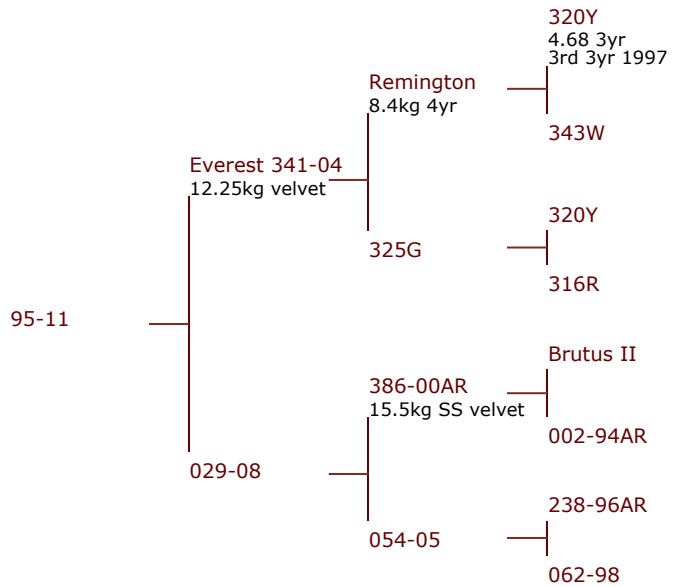



765-10

765-10 has first 2yr olds this year and is breeding well with his best 2yr old son as at 4/12/15 cutting 5.8kg and only one under 4kg from the 8 cut to date.



765-10 11.8kg SS @ 5yr

Progeny of 765-10

We have no photos of 765-10's progeny at present.

Tag# / Name	765-10DDF
Weaner weight	
Velvet 2 year	7.8kg SA
Velvet 3 year	8.1kg SA
Velvet 4 year	10.74kg SS
Velvet 5 year	11.8kg SS
Velvet 6 year	
Velvet 7 year	
Notes	

Pedigree

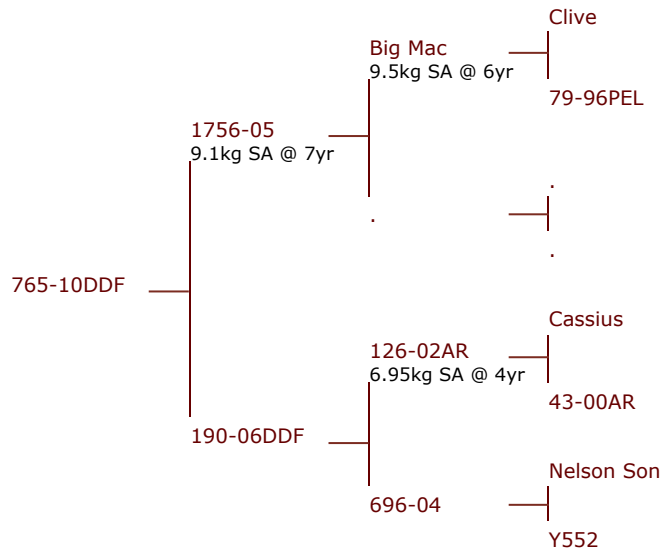

lot # 1 – 3yr sire stag



Animal: **12-105**

Birthdate: 2012

Weigh Date	Weight
26/03/2013	67 kg
21/01/2014	129 kg

Velvet Date	Weight	Grade
1/12/2015	8.20	
1/11/2014	4.65	

3yr Velvet weight: 8.2kg 2nd National 3yrs

Pedigree:

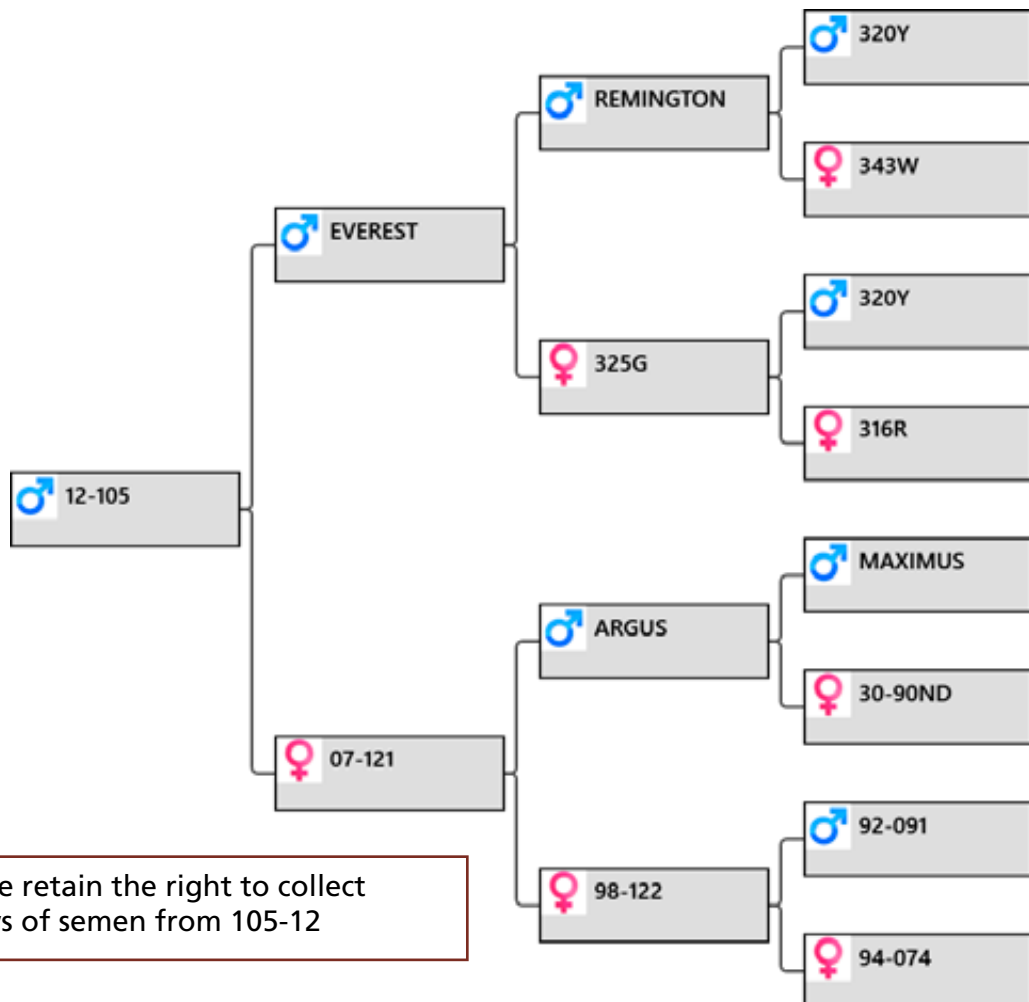

Note: We retain the right to collect 15 straws of semen from 105-12

Biography:

Dam 121-07 has a very good 2yr old son that cut a very nice head this year. Her first son cut 5.2kg @ 2yr but died. Grand dam 122-98 dam of lot 10 2013 \$,8800 & and grand dam of lot 1 2015 \$25,000 and 53-07 \$17,000 national 2yr champion. 105-12 placed 2nd at national velvet competition behind 188-10 that we are retaining. 105-12 has the 2nd best head we have ever bred behind 188-12 2015 champion. LW 15/12/15 216kg.

Sale weight:

Price:

Buyer:



lot # 2 – 3yr sire stag



Animal: **12-034**

Birthdate: 2012

Weigh Date	Weight
26/03/2013	82 kg
21/01/2014	149 kg

Velvet Date	Weight	Grade
1/12/2015	7.35	
1/11/2014	5.00	

3yr Velvet weight: 7.35kg

Pedigree:

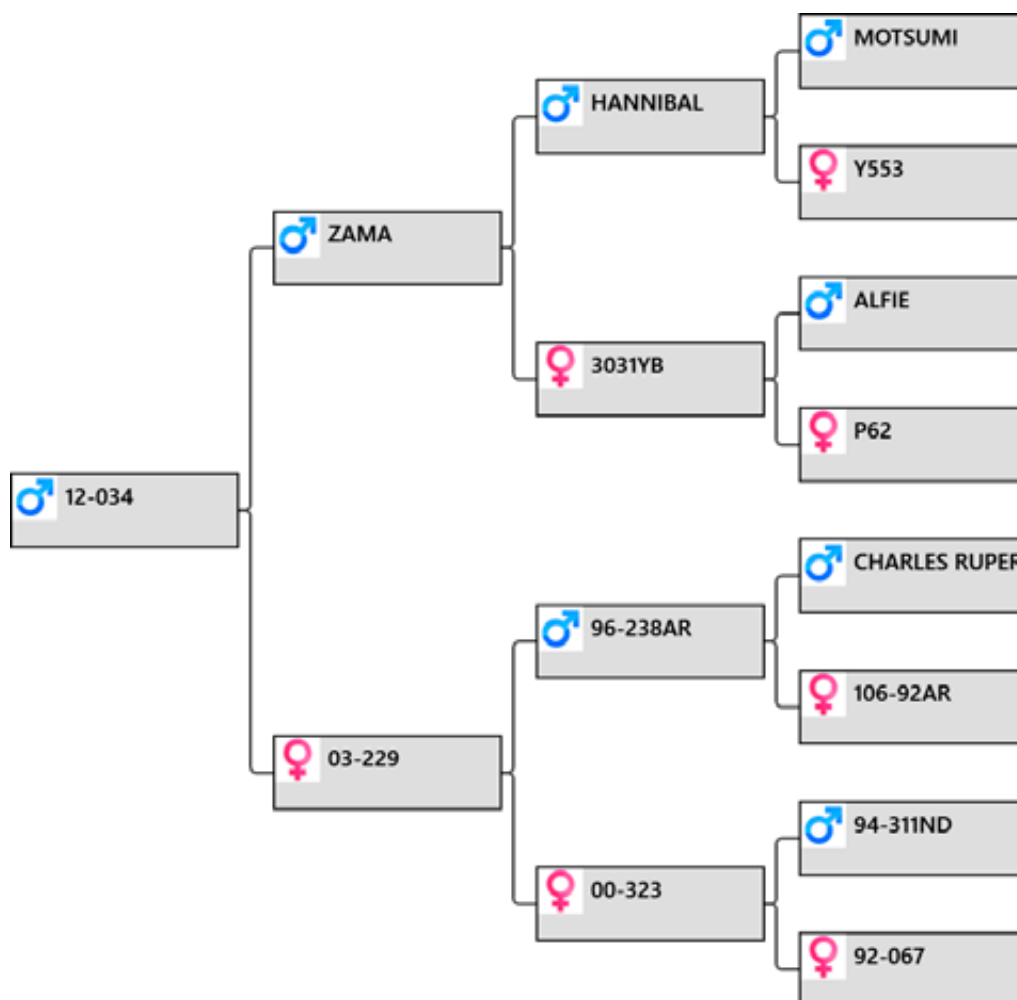

Biography:

Dam had son sold lot 4 2012 and 67-92 dam of 106-96 used in stud. Dam of 67-92 had 2 sons used in stud. Very clean tidy head of velvet off a heavy stag. We nearly kept this Zama son as a replacement stag as Zama died.

3 year weight 15/12/15 242kg

Sale weight:

Price:

Buyer:

lot # 3 – 3yr sire stag



Animal: **12-046**

Birthdate: 2012

Weigh Date	Weight
26/03/2013	67 kg
21/01/2014	127 kg

Velvet Date	Weight	Grade
1/12/2015	7.20	
1/07/2014	4.20	

3yr Velvet weight: 7.2kg

Pedigree:

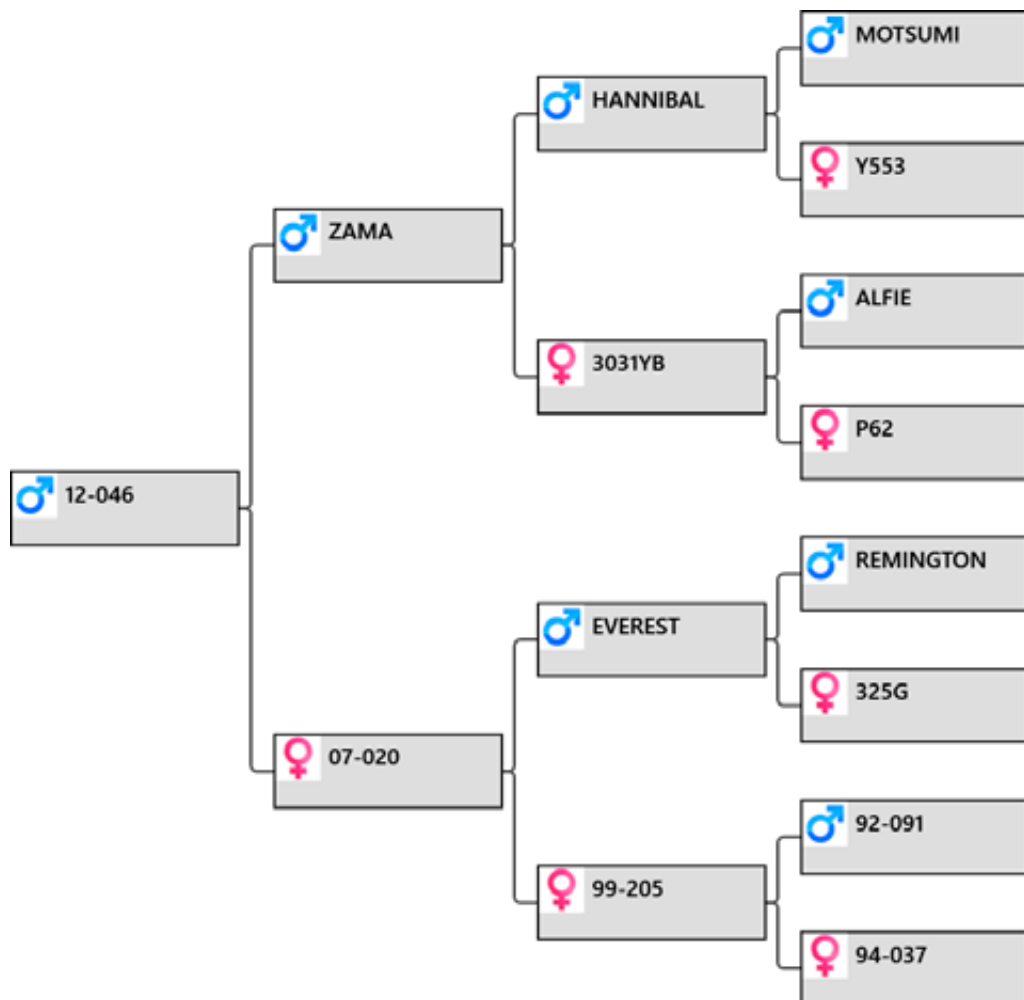

Biography:

Zama out of a very good Everest daughter. 46-12 has a 2yr old brother with the same 2yr velvet weight. 20-07 has 3 daughters with one being dam of lot 8 277-12 with very tidy 6.8kg velvet. 46-12 very clean tidy velvet. 3yr weight 15/12/15 242kg

Sale weight:

Price:

Buyer:



lot # 4 – 3yr sire stag



Animal: **12-174**

Birthdate: 2012

Weigh Date	Weight
26/03/2013	79 kg
21/01/2014	143 kg

Velvet Date	Weight	Grade
1/12/2015	7.05	
1/11/2014	4.75	

3yr Velvet weight: 7.05kg

Pedigree:

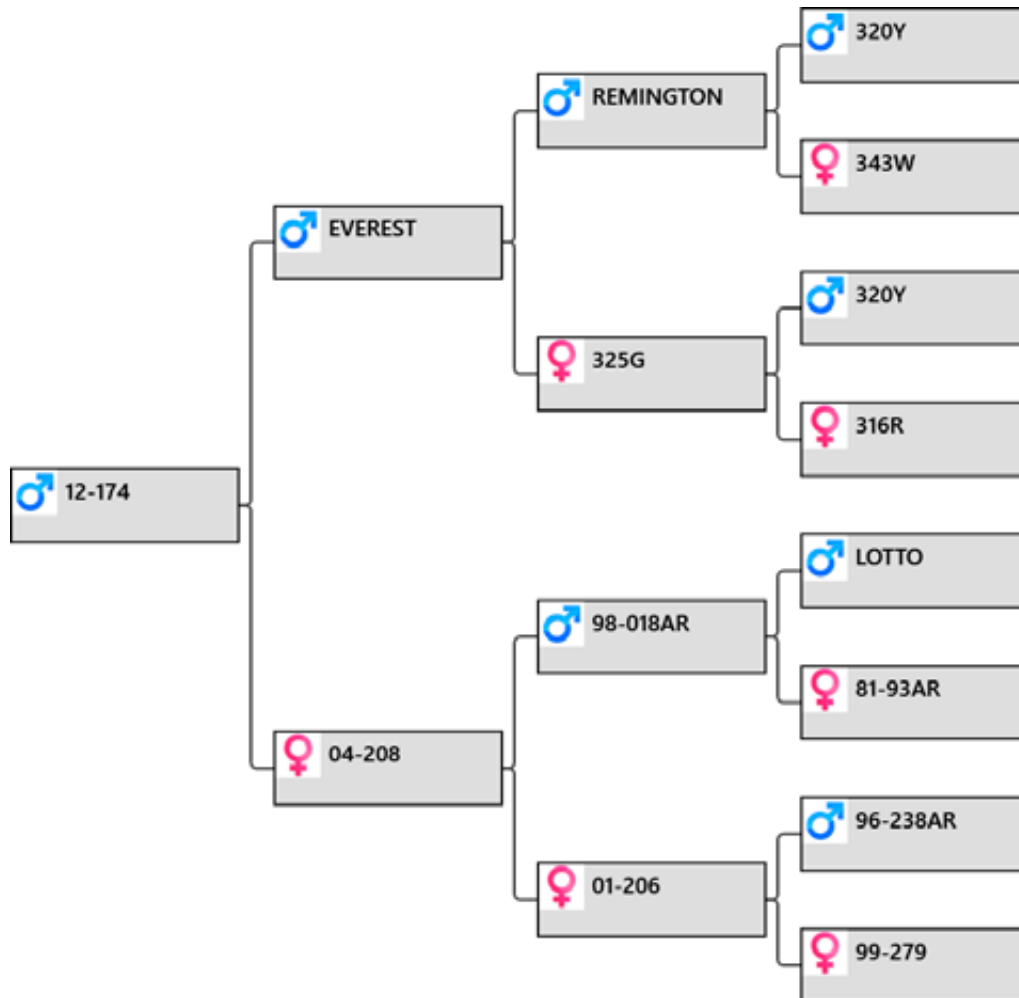

Biography:

Very tidy clean velvet on big stag. He has ET brothers lots 11, 21, and lot 23 all with good heads. His dam 208-04 top hind with sons sold 2014 91-09 \$5,000. 2012 219-08 \$2,500, and 2011 76-07 \$10500. Her daughter 76-06 dam of lot 25 1-12 6.15kg velvet. 3yr weight 15/12/15 245kg

Sale weight:

Price:

Buyer:

lot # 5 – 3yr sire stag



Animal: **12-122**

Birthdate: 2012

Weigh Date	Weight
26/03/2013	64 kg
21/01/2014	133 kg

Velvet Date	Weight	Grade
1/12/2015	6.95	
1/11/2014	4.40	

3yr Velvet weight: 6.95kg

Pedigree:

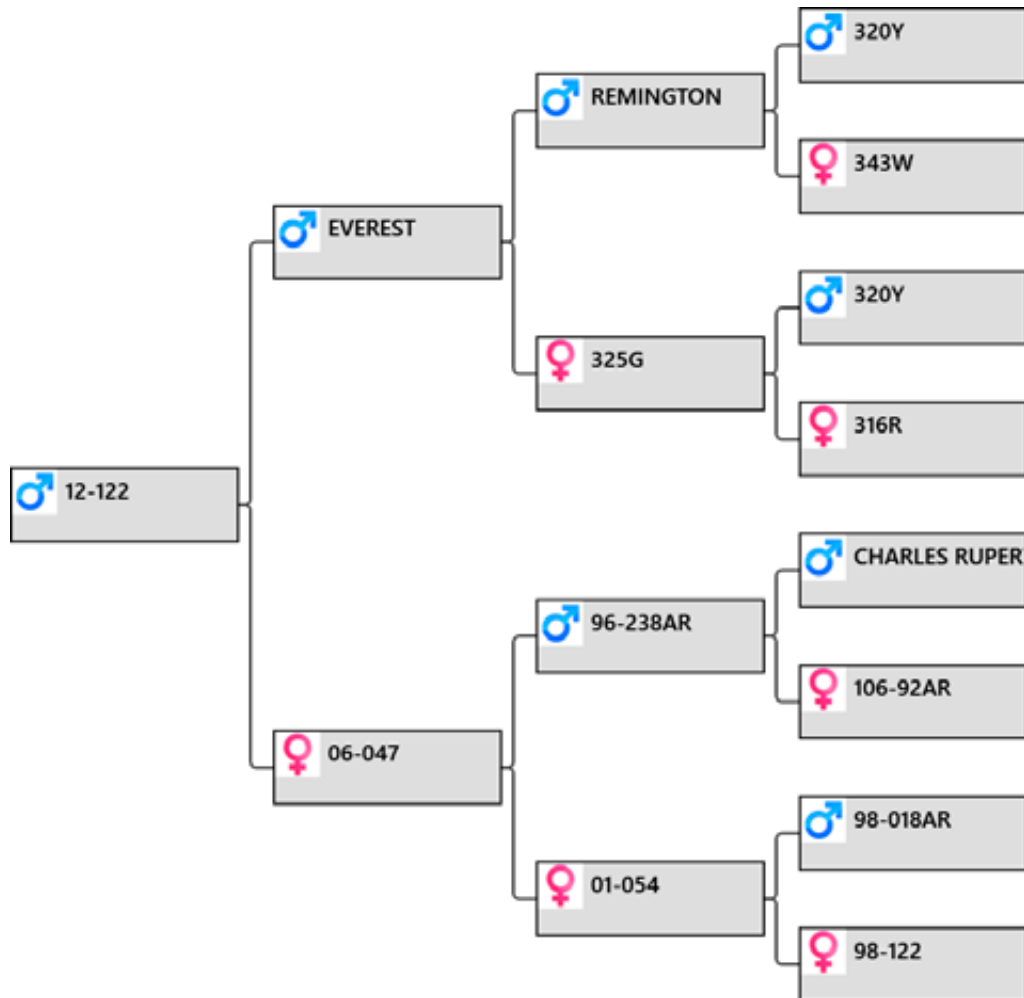

Biography:

Very nice balanced head off this Everest son. Grand dam 54-01 has had 3 sons sold at auction. 122-98 dam of lot 10 2013 \$8,800. Grand dam of lot 1 2015 \$25,000. Grand dam of lot 1 this year and grand dam of 53-07 sold for \$17,000 and 2yr national champion. 3yr weight 15/12/15 207kg.

Sale weight:

Price:

Buyer:



lot # 6 – 3yr sire stag



Animal: **12-216**

Birthdate: 2012

Weigh Date	Weight
26/03/2013	81 kg
21/01/2014	146 kg

Velvet Date	Weight	Grade
1/12/2015	7.40	
1/11/2014	5.75	

3yr Velvet weight: 7.40kg

Pedigree:

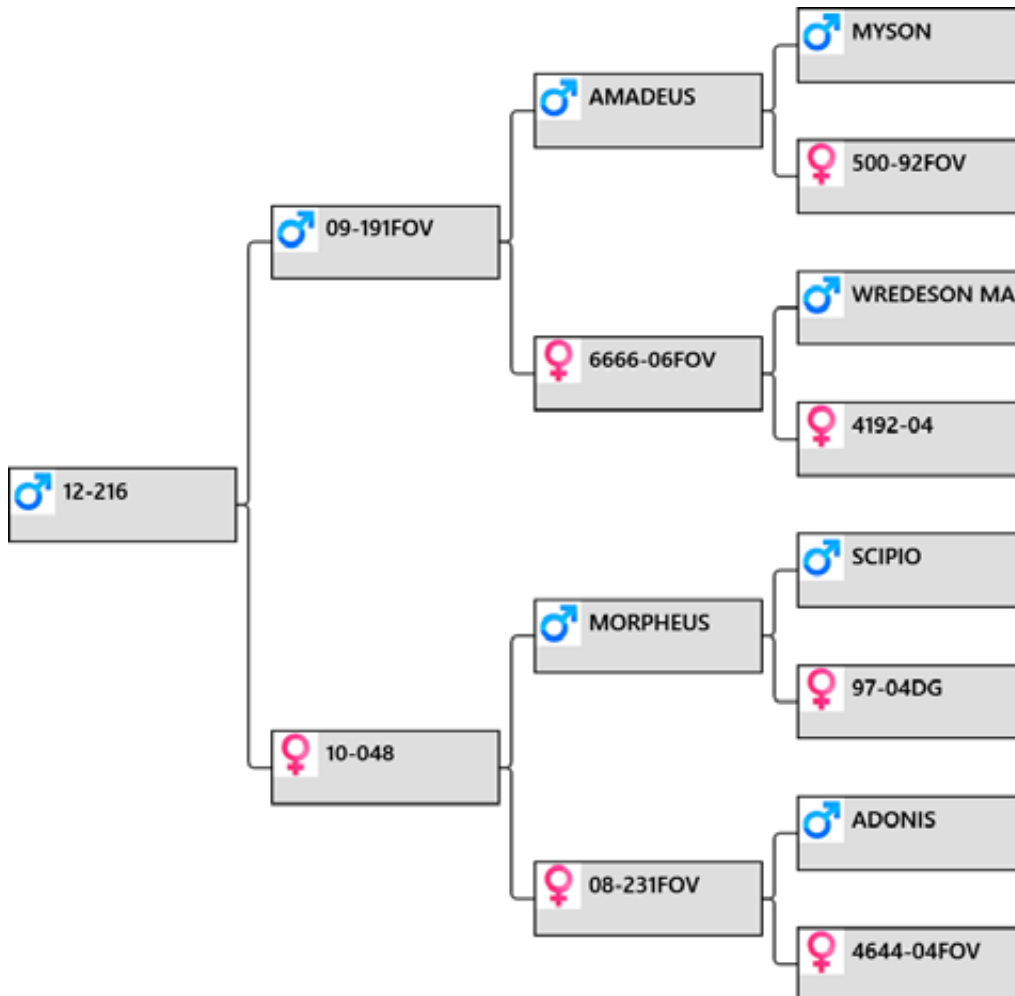

Biography:

216-12 by ET. Huge trezs and bulb on this head and very clean. Very big stag bred for trophy and velvet. Has brother lot 18. Dam 48-10 has ET sister 53-10 with a son cutting 7.4kg at 3yr. Very strong trophy pedigree.

3yr weight 15 /12/15 245kg

Sale weight:

Price:

Buyer:

lot # 7 – 3yr sire stag



Animal: **12-150**

Birthdate: 2012

Weigh Date	Weight
26/03/2013	75 kg
21/01/2014	156 kg

Velvet Date	Weight	Grade
1/12/2015	7.20	
1/11/2014	4.45	

3yr Velvet weight: 7.20kg

Pedigree:

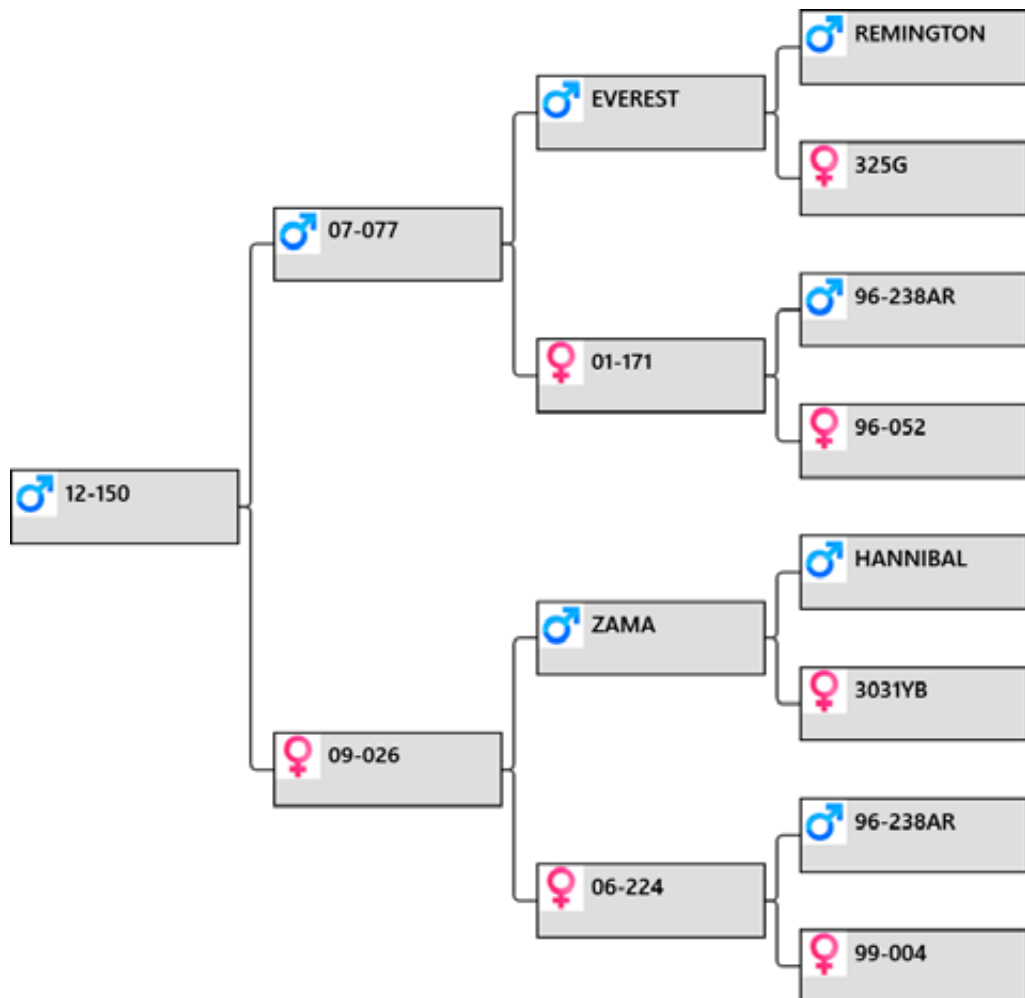

Biography:

Very big stag and velvet with his left stick cut different day and weighing 4kg. Huge bulbs and trezs. 77-07 sold for \$15,000 to make way for more Everest sons.
3yr weight 15/12/15 253kg

Sale weight:

Price:

Buyer:



lot # 8 – 3yr sire stag



Animal: **12-277**

Birthdate: 2012

Weigh Date	Weight
26/03/2013	59 kg
21/01/2014	119 kg

Velvet Date	Weight	Grade
1/12/2015	6.80	
1/11/2014	4.40	

3yr Velvet weight: 6.80kg

Pedigree:

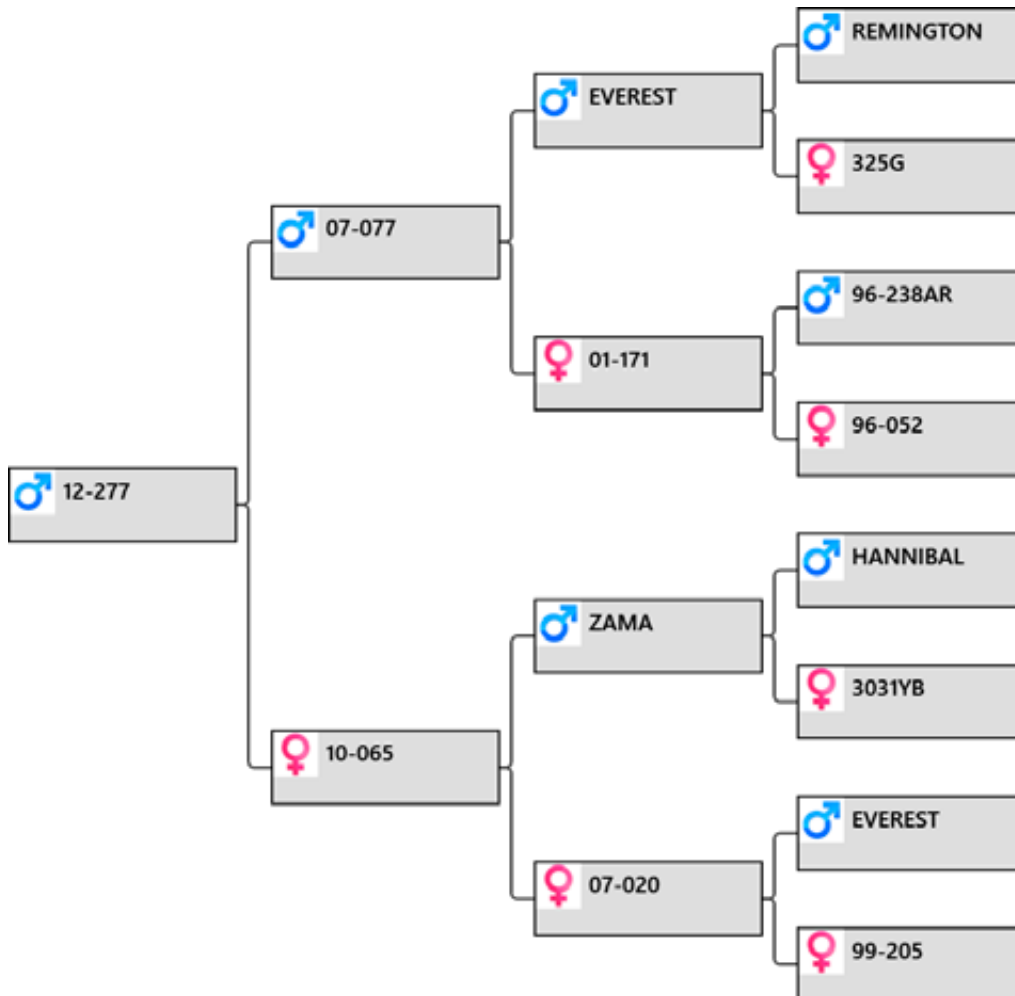

Biography:

Once again very tidy velvet on 277-12 and he is out of a 2nd fawner. Grand dam 20-07 is dam of lot 3 46-12 that we considered keeping to replace Zama. A double up of Everest in this pedigree.

3yr weight 15/12/15 211kg

Sale weight:

Price:

Buyer:

lot # 9 – 3yr sire stag



Animal: **12-012**

Birthdate: 2012

Weigh Date	Weight
26/03/2013	64 kg
21/01/2014	122 kg

Velvet Date	Weight	Grade
1/12/2015	8.40	
1/11/2014	5.40	

3yr Velvet weight: 8.40kg

Pedigree:

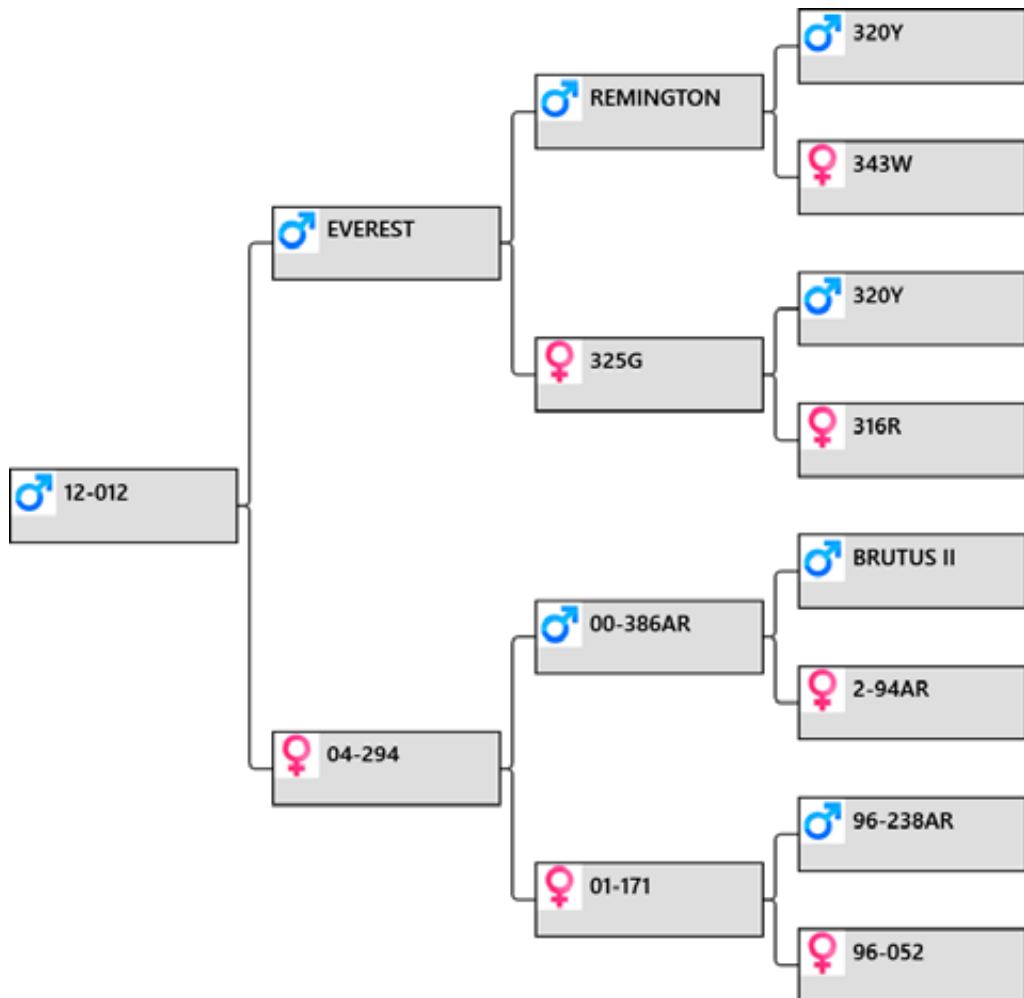

Biography:

Very heavy velvet but left stick has damage on back of beam. 294-04 another top hind with a son, full brother to 12-12 sold lot 4 2015 for \$15,500. Her daughter 280-06 had a son sold 2013 for \$3000. 171-01 dam of our stud sire 77-07. 3yr weight 15/12/15 207kg.

Sale weight:

Price:

Buyer:



lot # 10 – 3yr sire stag



Animal: **12-198**

Birthdate: 2012

Weigh Date	Weight
26/03/2013	70 kg
21/01/2014	133 kg

Velvet Date	Weight	Grade
1/12/2015	7.15kg	
1/11/2014	4.20	

3yr Velvet weight: 7.15kg

Pedigree:

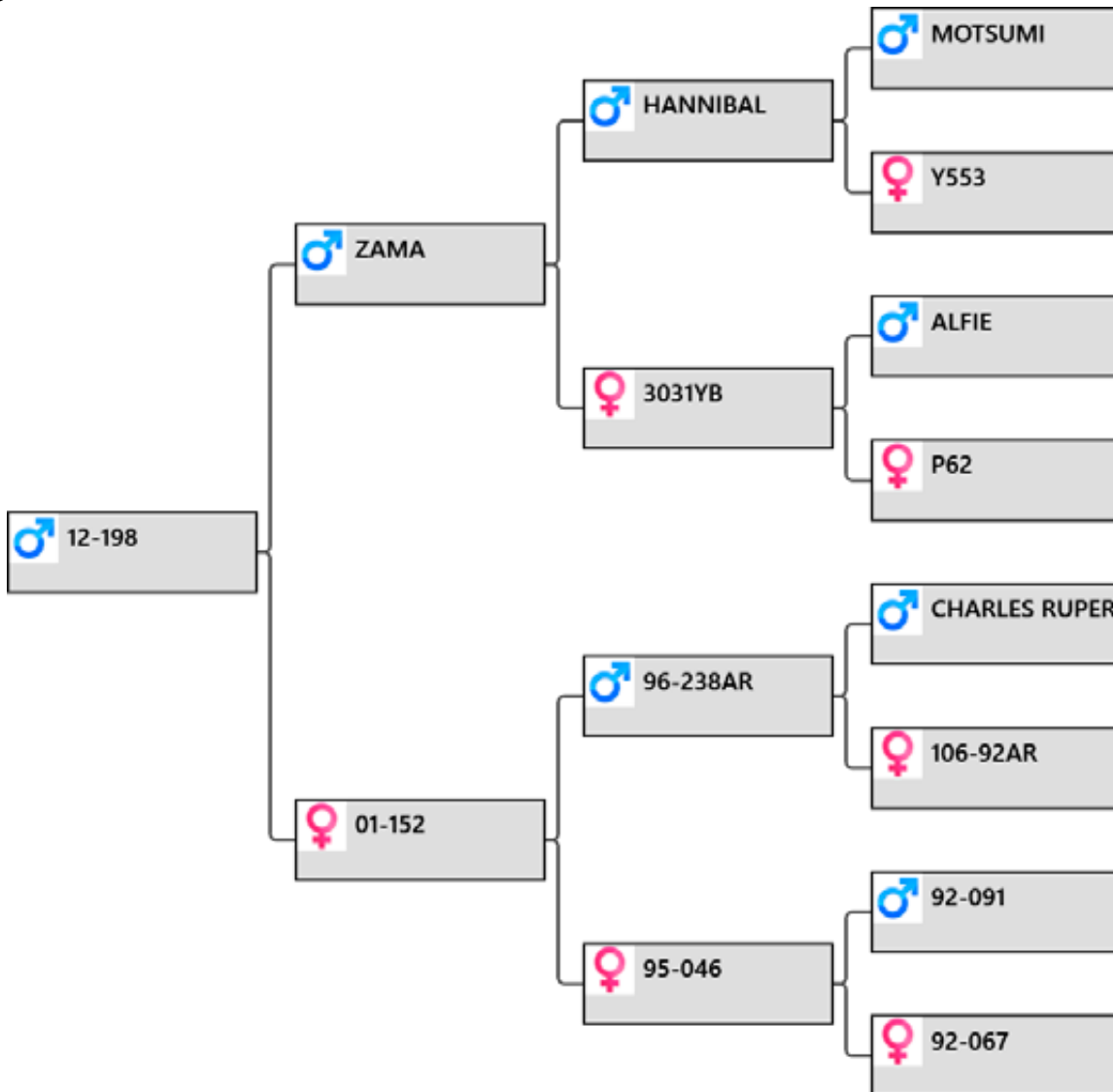

Sale weight:

Price:

Buyer:

Biography for 12-198:

Should have grown out this head but was one of the first stags velveted and cut him as over 7kg. 152-01 top hind with son sold for \$10500 to Alf Kinzett and 142-09 (Victrix) sold to John Somerville, Arawata stud, for \$10,500. 198-12 is a full brother. Spiker 177-14 is out of 184-12 a full sister to Victrix and 198-12. Spiker velvet in photo is cut just above his partly grown bottom tynes and is 22cm at the cut, and bulbs are 40 and 41cm. 46-95 top hind with son 186-04 sold to Alan Stewart for \$20,000. 186-04 head displayed on wall at Altrive sale venue. 3yr weight 15/12/15 219kg



177-14
1.75kg as spiker. Bulbs 40 and 41cm and 22cm beam at the cut.



142-09 - Victrix sold to Arawata stud.
Victrix @ 6yr



177-14



142-09 - Victrix sold to Arawata stud.
Victrix growing out @ 6yr



lot # 11 – 3yr sire stag



Animal: **12-185**

Birthdate: 2012

Weigh Date	Weight
26/03/2013	76 kg
21/01/2014	133 kg

Velvet Date	Weight	Grade
1/12/2015	6.45	
1/11/2014	4.35	

3yr Velvet weight: 6.45kg

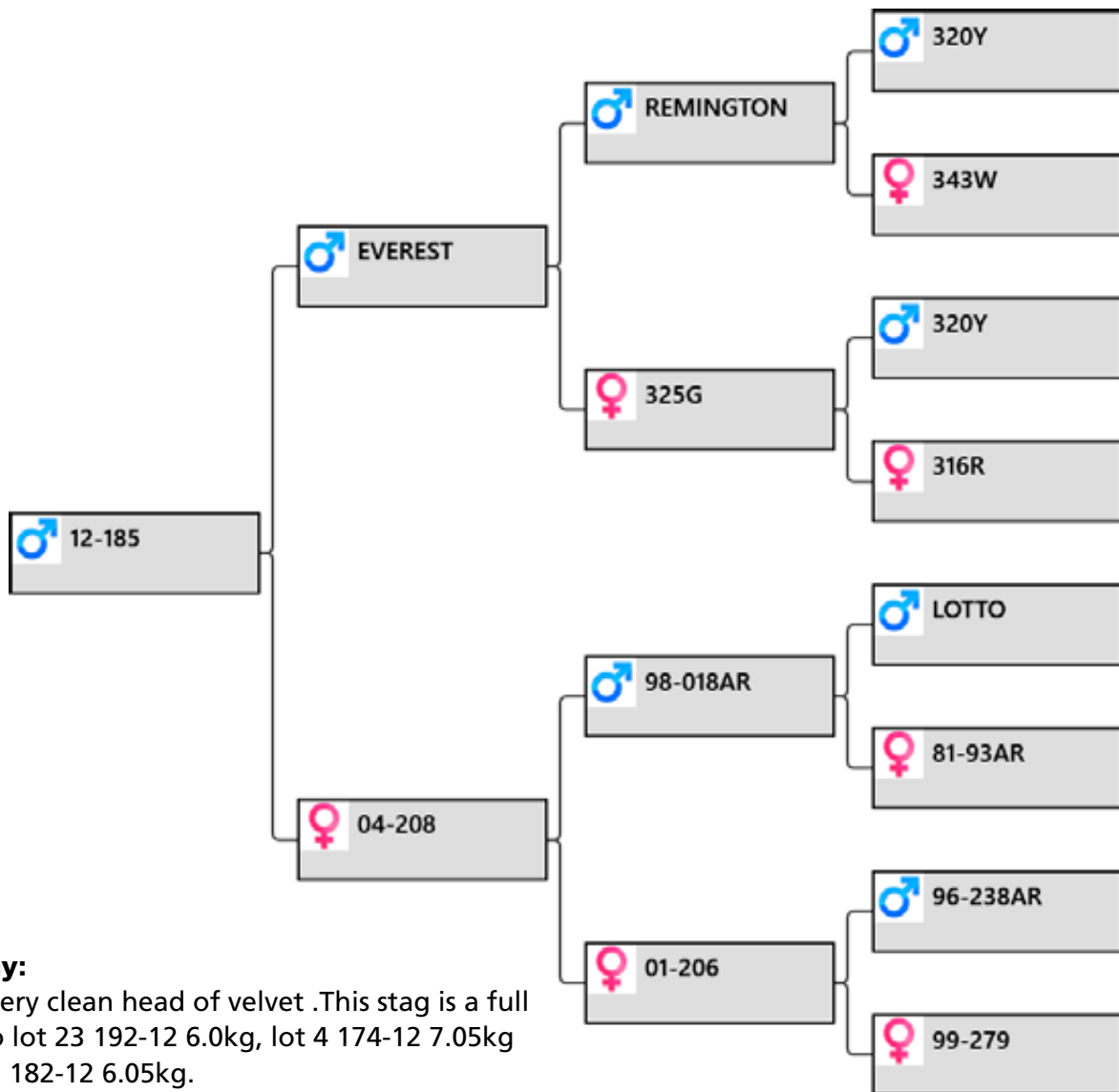

Biography:

Another very clean head of velvet .This stag is a full brother to lot 23 192-12 6.0kg, lot 4 174-12 7.05kg and lot 21 182-12 6.05kg.

208-04 had sons sold; 2014 91-09 \$5000, 2012 219-08 \$2500, 76-07 sold for \$10,500. Her daughter 76-06 dam of lot 25 1-12 6.15kg velvet.

3yr year weight 15/12/15 218kg

Sale weight:

Price:

Buyer:

lot # 12 – 3yr sire stag



Animal: **12-169**

Birthdate: 2012

Weigh Date	Weight
26/03/2013	63 kg
21/01/2014	129 kg

Velvet Date	Weight	Grade
1/12/2015	6.40	
1/11/2014	4.90	

3yr Velvet weight: 6.40kg

Pedigree:

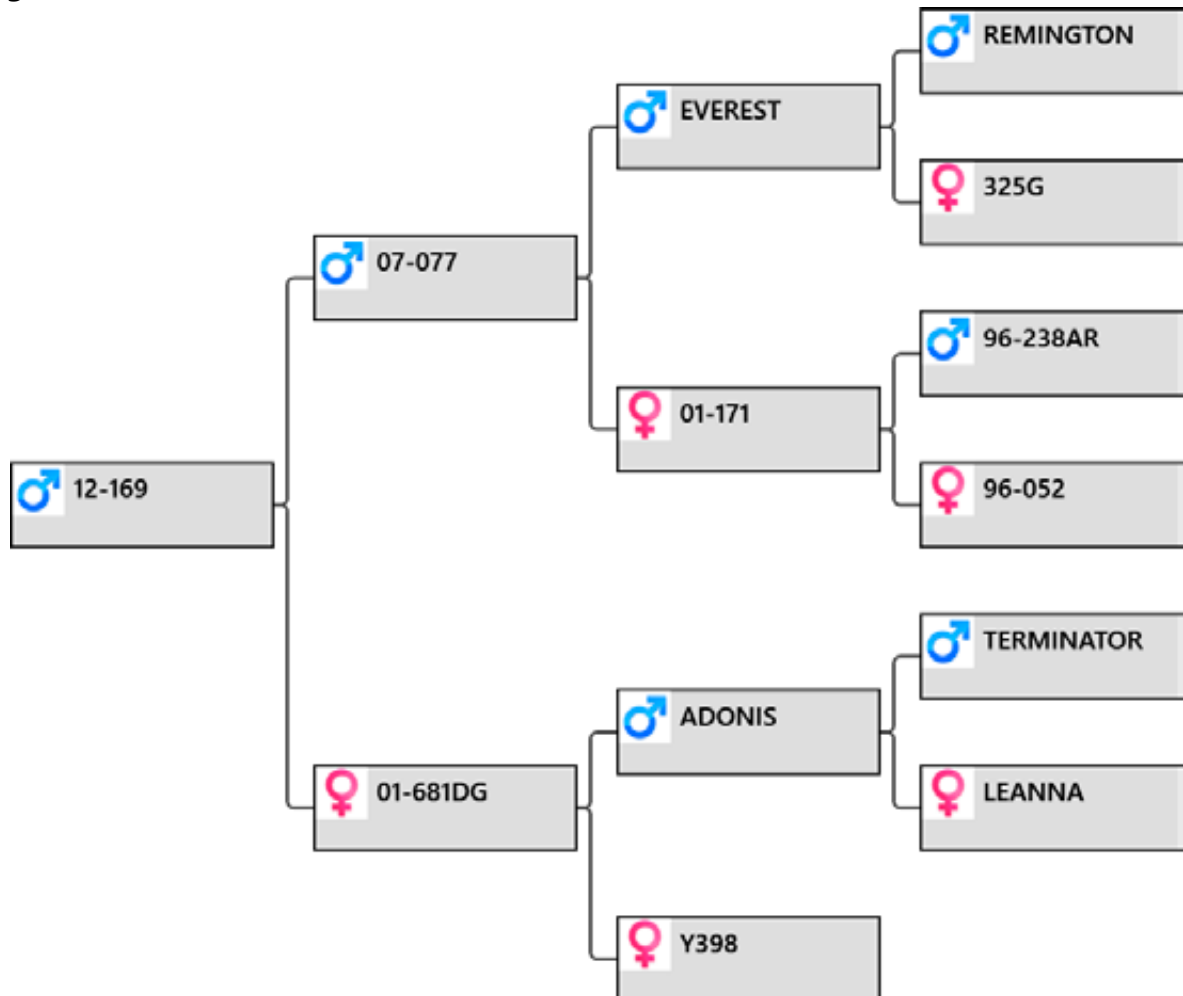

Biography:

Small snags on this tidy velvet. 169-12 out of an Adonis daughter.
 3yr weight 15/12/15 218kg

Sale weight:

Price:

Buyer:



lot # 13 – 3yr sire stag



Animal: **12-126**

Birthdate: 2012

Weigh Date	Weight
26/03/2013	70 kg
21/01/2014	139 kg

Velvet Date	Weight	Grade
1/12/2015	6.20	
1/11/2014	4.30	

3yr Velvet weight: 6.20kg

Pedigree:

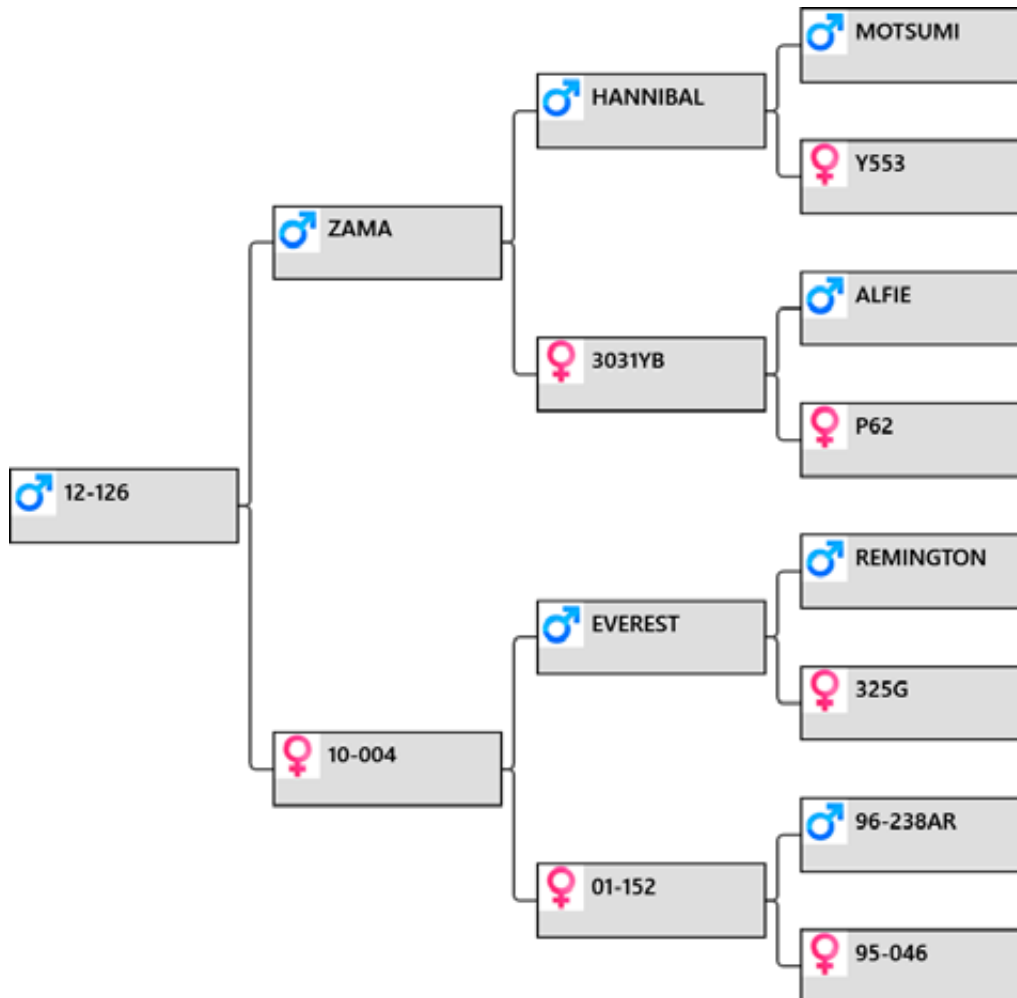

Biography:

Very clean balanced head of velvet. 4-10 well bred hind with daughter sold for \$3400 2014. 152-01 dam of stag sold Alf Kinzett \$10,500 and 142-09 (Victrix) \$10,500 sold to Arawata Deer Stud. 46-95 dam of Altrive sire stag 186-04 then sold to Alan Stewart for \$20,000 3yr weight 15/12/15 238kg

Sale weight:

Price:

Buyer:

lot # 14 – 3yr sire stag



Animal: **12-098**

Birthdate: 2012

Weigh Date	Weight
26/03/2013	62 kg
21/01/2014	126 kg

Velvet Date	Weight	Grade
1/12/2015	6.00	
1/11/2014	4.20	

3yr Velvet weight: 6.00kg

Pedigree:

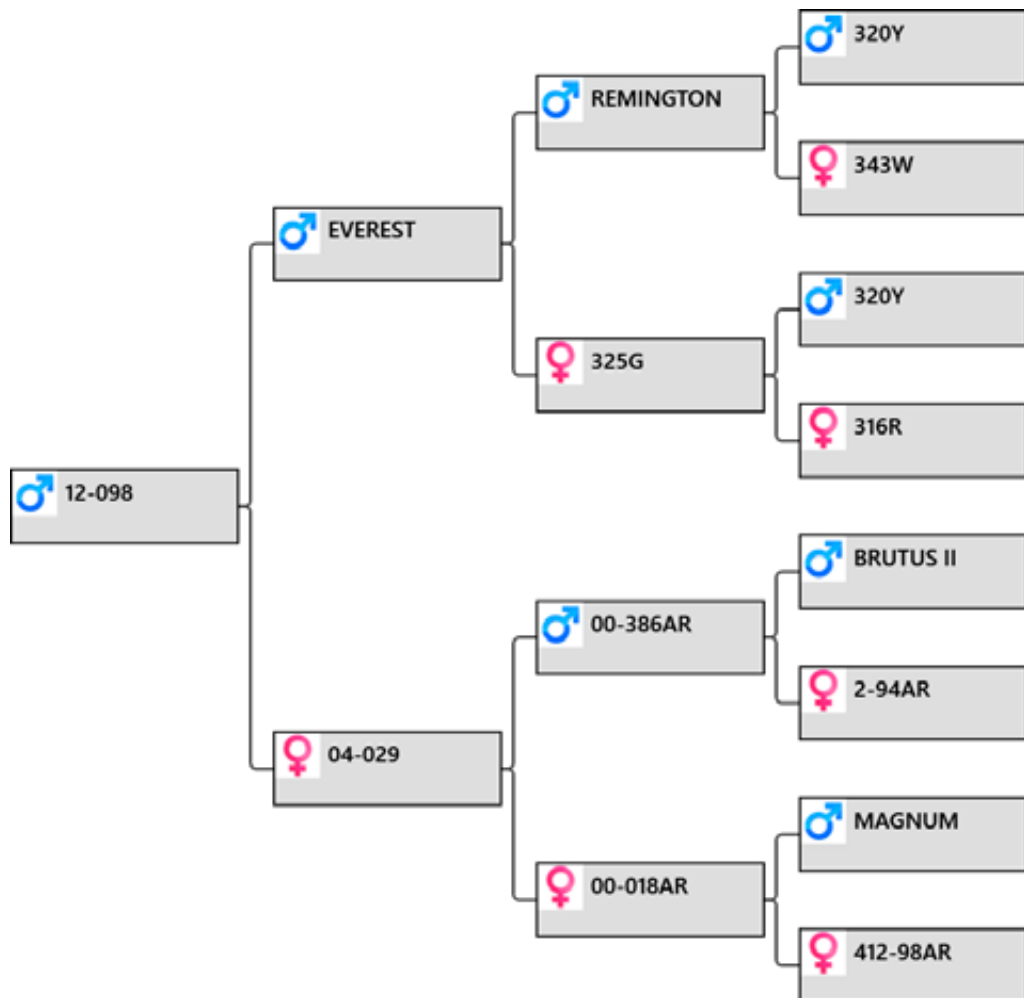

Biography:

Another Everest son with very clean velvet. 29-04 dam of lot 13 2015 \$9500.
 3yr weight 15/12/15 218kg

Sale weight:

Price:

Buyer:



lot # 15 – 3yr sire stag



Animal: **12-177**

Birthdate: 2012

Weigh Date	Weight
26/03/2013	70 kg
21/01/2014	130 kg

Velvet Date	Weight	Grade
1/12/2015	7.00	
1/11/2014	4.50	

3yr Velvet weight: 7.00kg

Pedigree:

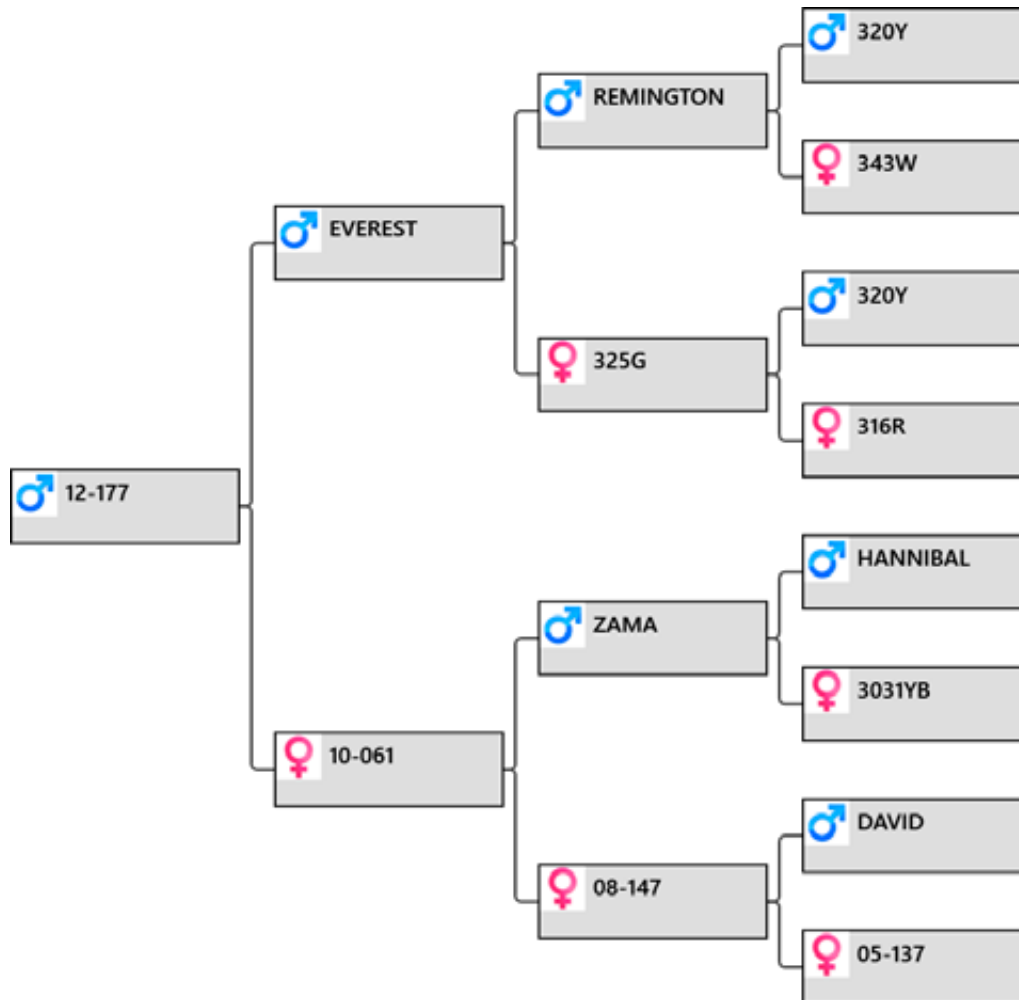

Biography:

Very clean head off this ET brother to 188-12 10.35 kg velvet and 2015 3yr national champion. 177-12 not in the same class but still a very good 3yr old. They have hree female sibling. 61-10 has full sister 39-10 dam of lot 24 249-12 6.05kg velvet. 137-05 dam of 2yr olds cutting 4.7kg and 195-07 6.85 kg sold to Alan Stewart 3yr weight 15/12/15 198kg

Sale weight:

Price:

Buyer:

lot # 16 – 3yr sire stag



Animal: **12-023**

Birthdate: 2012

<u>Weigh Date</u>	<u>Weight</u>
26/03/2013	62 kg
21/01/2014	112 kg

<u>Velvet Date</u>	<u>Weight</u>	<u>Grade</u>
1/12/2015	6.85	
1/11/2014	4.60	

3yr Velvet weight: 6.85kg

Pedigree:

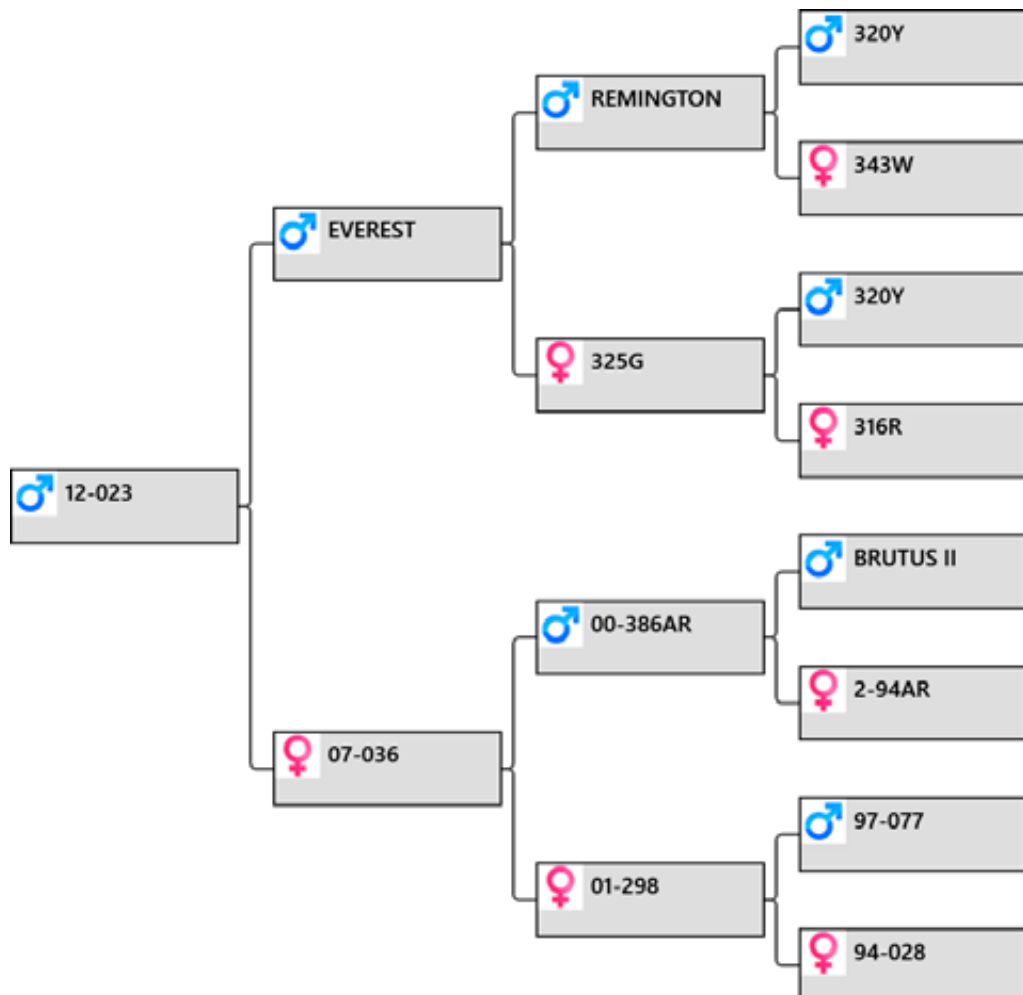

Biography:

23-12 has nice head of velvet in photo but it has a 2nd trez on back of left stick. 23-12 is a twin and dam 36-07 has produced 2 sets. 298-01 top hind , dam of 26-10 sold 2014 \$9,000 and 106-09 sold 2013 \$4,800.

3yr weight 15/12/15 185kg. Not as heavy as some, but he is a twin.

Sale weight:

Price:

Buyer:



lot # 17 – 3yr sire stag



Animal: **12-051**

Birthdate: 2012

Weigh Date	Weight
26/03/2013	65 kg
21/01/2014	120 kg

Velvet Date	Weight	Grade
1/12/2015	6.35	
1/07/2014	5.50	

3yr Velvet weight: 6.35kg

Pedigree:

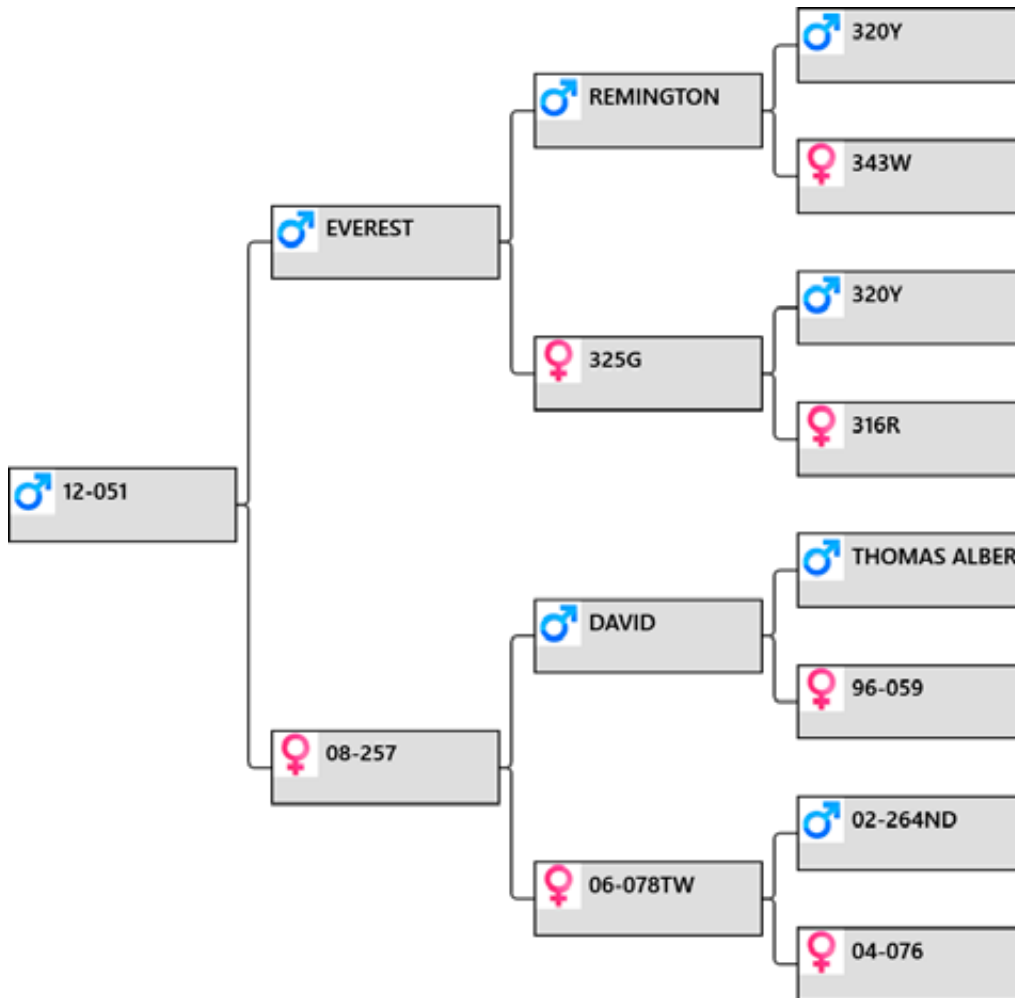

Biography:

Snags but balanced head with good trezs. By our top sire Everest once again. 76-04 son sold 2013 \$4,000.

3yr weight 15/12/15 193 kg.

Sale weight:

Price:

Buyer:

lot # 18 – 3yr sire stag



Animal: **12-219**

Birthdate: 2012

Weigh Date	Weight
26/03/2013	67 kg
21/01/2014	126 kg

Velvet Date	Weight	Grade
1/12/2015	6.10	
1/11/2014	4.30	

3yr Velvet weight: 6.10kg

Pedigree:

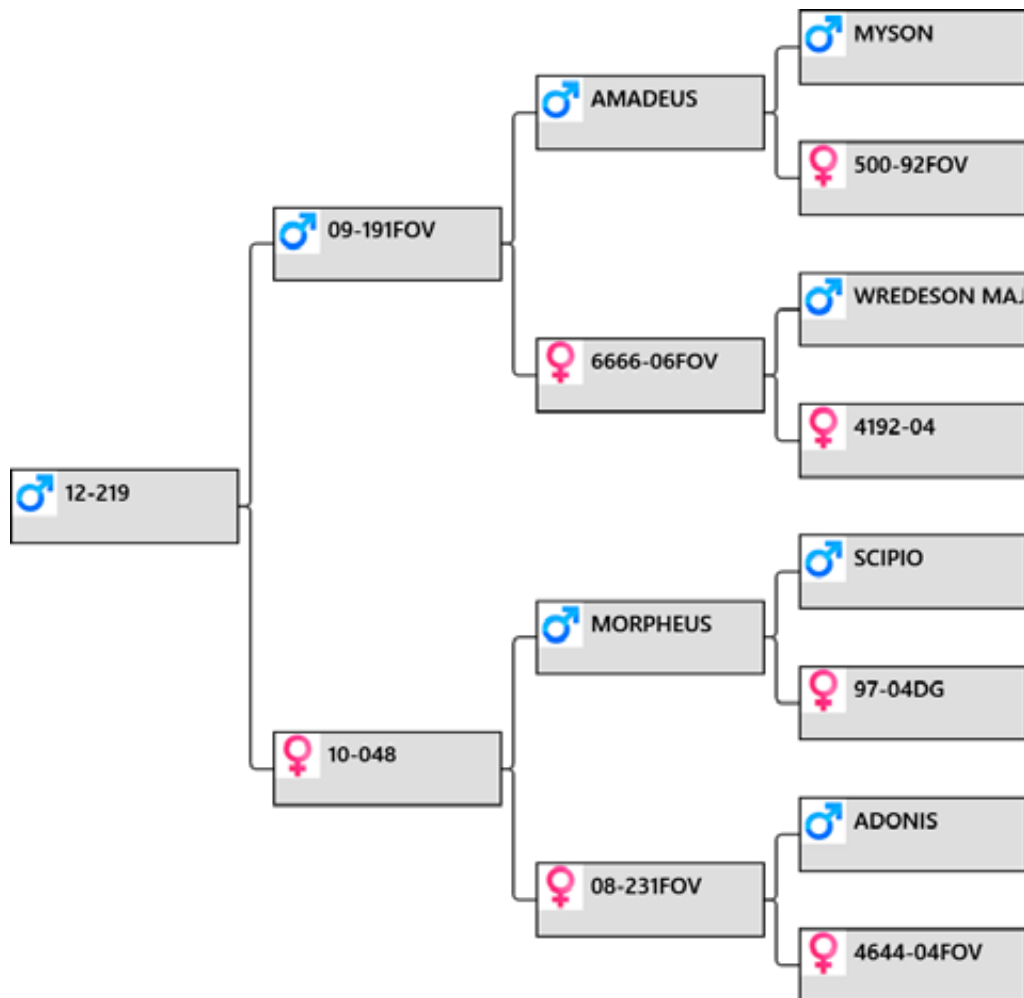

Biography:

219-12 has velvet with strong tynes and is very symmetrical. ET brother to lot 6 216-12 7.4kg. Dam 48-10 has full sister 53-10 who is dam of 200-12 7.4 kg velvet. 3yr weight 15/12/15 198kg.

Sale weight:

Price:

Buyer:



lot # 19 – 3yr sire stag



Animal: **12-054**

Birthdate: 2012

Weigh Date	Weight
26/03/2013	76 kg
21/01/2014	143 kg

Velvet Date	Weight	Grade
1/12/2015	6.05	
1/07/2014	4.70	

3yr Velvet weight: 6.05kg

Pedigree:

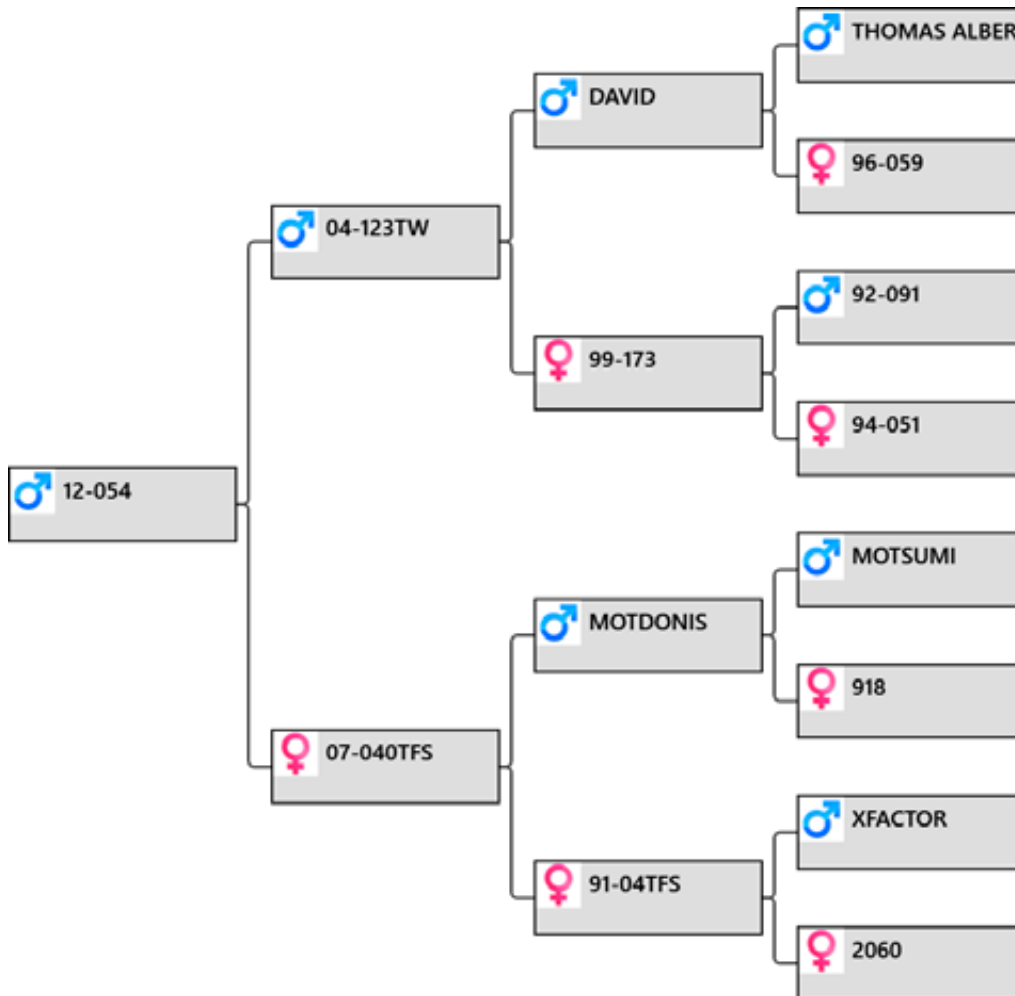

Biography:

Very nice balanced head of velvet. Good velvet genetics plus trophy with 123-04 502 IOA at 4yr and Motdonis.

3yr weight 15/12/15 228kg.

Sale weight:

Price:

Buyer:

lot # 20 – 3yr sire stag



Animal: **12-294**

Birthdate: 2012

Weigh Date	Weight
26/03/2013	55 kg
21/01/2014	136 kg

Velvet Date	Weight	Grade
1/12/2015	6.20	
1/11/2014	5.45	

3yr Velvet weight: 6.20kg

Pedigree:

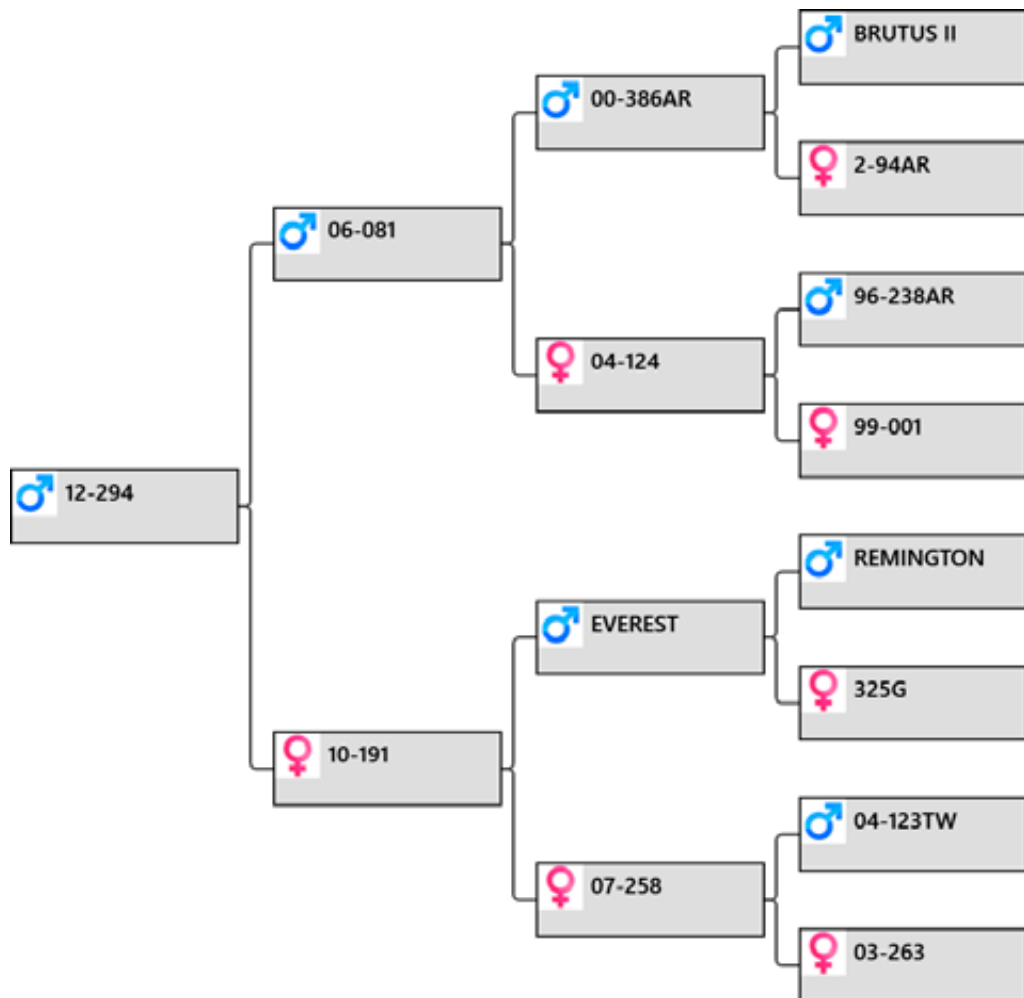

Biography:

His left stick of velvet was damaged soon after button drop, right side very tidy. Heavy stag. 81-06 cut 17.2kg SS velvet. 81-06 national 4yr champion and sire of lot one 2014 sold for \$20,000. 3yr weight 15/12/15 244kg

Sale weight:

Price:

Buyer:



lot # 21 – 3yr sire stag



Animal: **12-182**

Birthdate: 2012

Weigh Date	Weight
26/03/2013	69 kg
21/01/2014	134 kg

Velvet Date	Weight	Grade
1/12/2015	6.05	
1/11/2014	4.20	

3yr Velvet weight: 6.05kg

Pedigree:

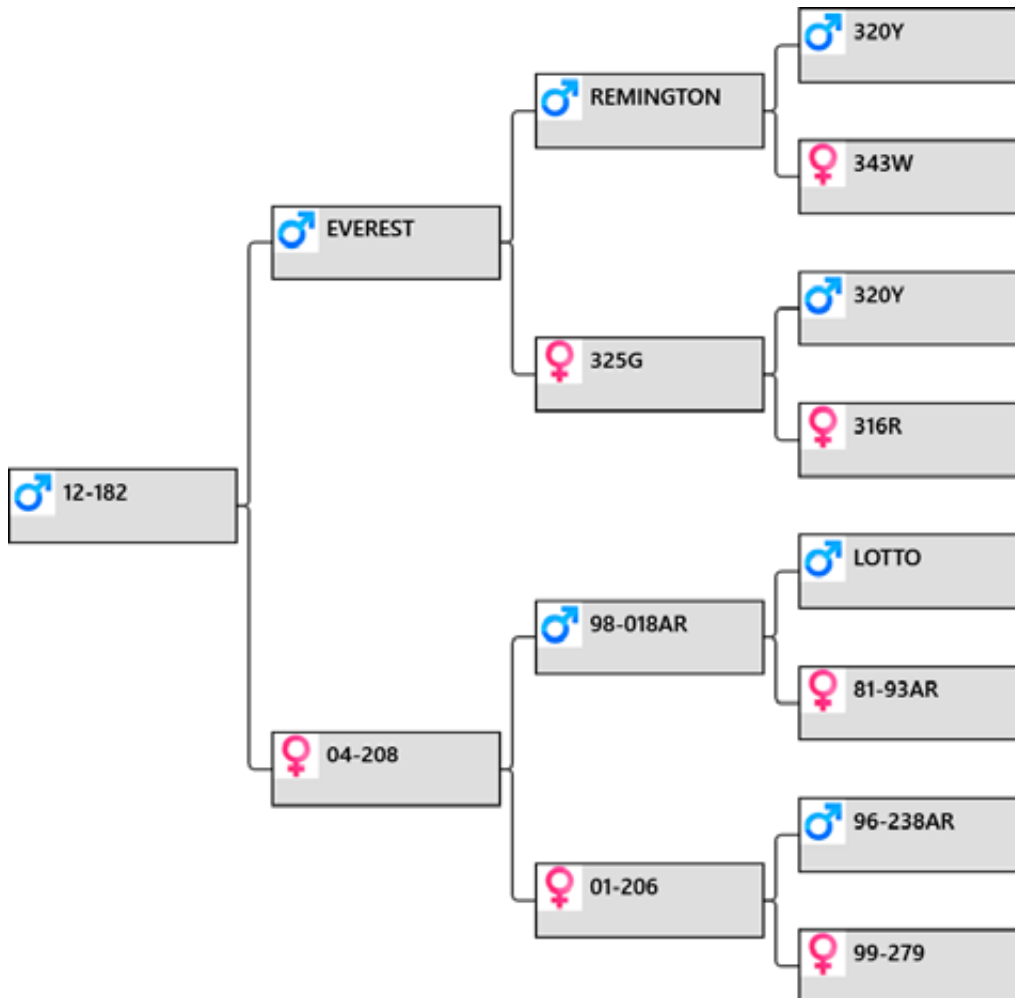

Biography:

Once again a very correct and balanced head. ET brother to lot 4 174-12 7.05kg and lot 11 185-12 6.45kg and lot 23 192-12 6.0 kg. 208-04 also dam of 91-09 sold 2014 \$5,000, 219-08 sold 2012 \$2,500 and 76-07 sold \$10,500 2011. 3yr weight 15/12/15 214kg

Sale weight:

Price:

Buyer:

lot # 22 – 3yr sire stag



Animal: **12-071**

Birthdate: 2012

Weigh Date	Weight
26/03/2013	79 kg
21/01/2014	143 kg

Velvet Date	Weight	Grade
1/12/2015	6.20	
1/11/2014	4.00	

3yr Velvet weight: 6.20kg

Pedigree:

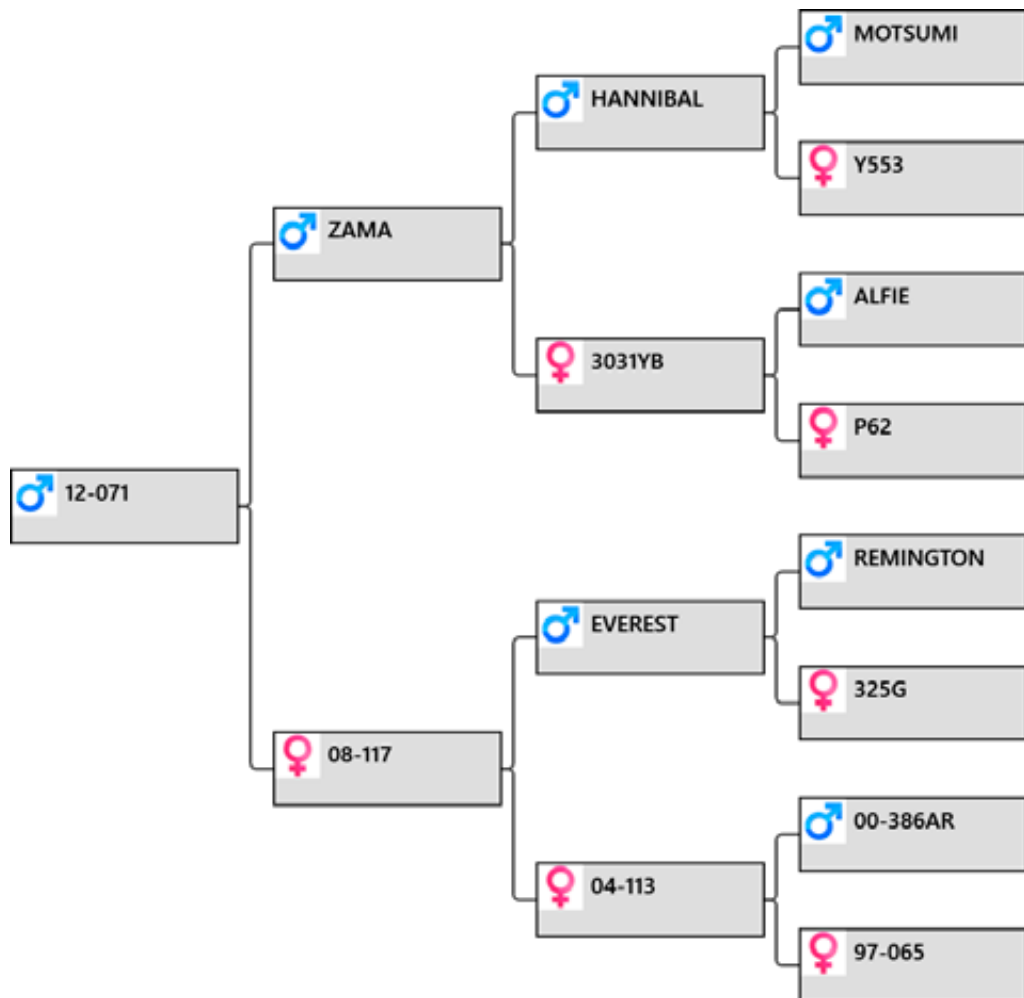

Biography:

Exceptionally clean head of velvet. Dam 117-08, son sold 2015 \$4,000. Zama over Everest very good cross. Heavy stag at 244kg. Weight 15/12/15 244kg

Sale weight:

Price:

Buyer:



lot # 23 – 3yr sire stag



Animal: **12-192**

Birthdate: 2012

Weigh Date	Weight
26/03/2013	72 kg
21/01/2014	134 kg

Velvet Date	Weight	Grade
1/12/2015	6.00	
1/11/2014	4.50	

3yr Velvet weight: 6.00kg

Pedigree:

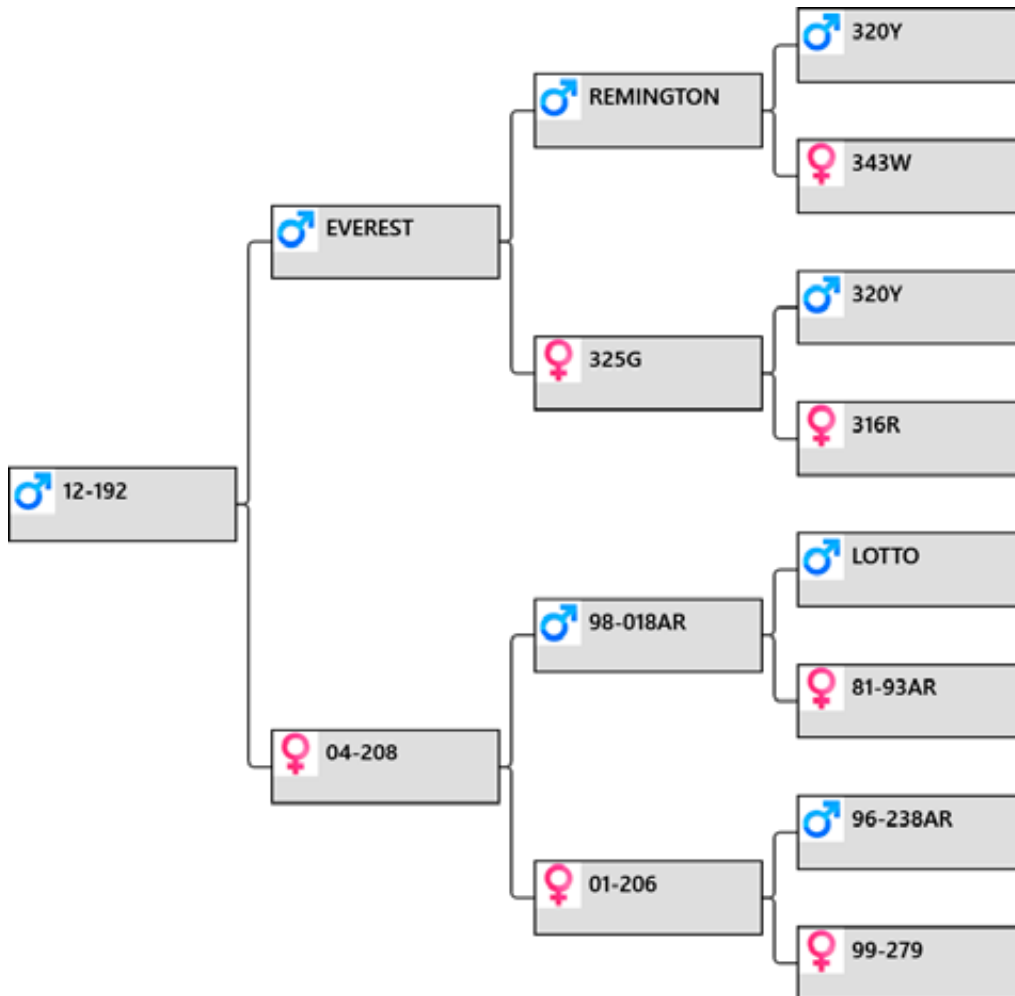

Biography:

Correct head with only shows for snags. ET brother to lots 4, 11, 21, and dam 208-04 also dam of 91-09 sold 2014 \$5,000, 219-08 sold 2012 \$2,500, and 76-07 sold \$10,500. 3yr weight 15/12/15 216kg

Sale weight:

Price:

Buyer:

lot # 24 – 3yr sire stag



Animal: **12-249**

Birthdate: 2012

Weigh Date	Weight
26/03/2013	61 kg
21/01/2014	115 kg

Velvet Date	Weight	Grade
1/12/2015	6.05	
1/11/2014	4.50	

3yr Velvet weight: 6.05kg

Pedigree:

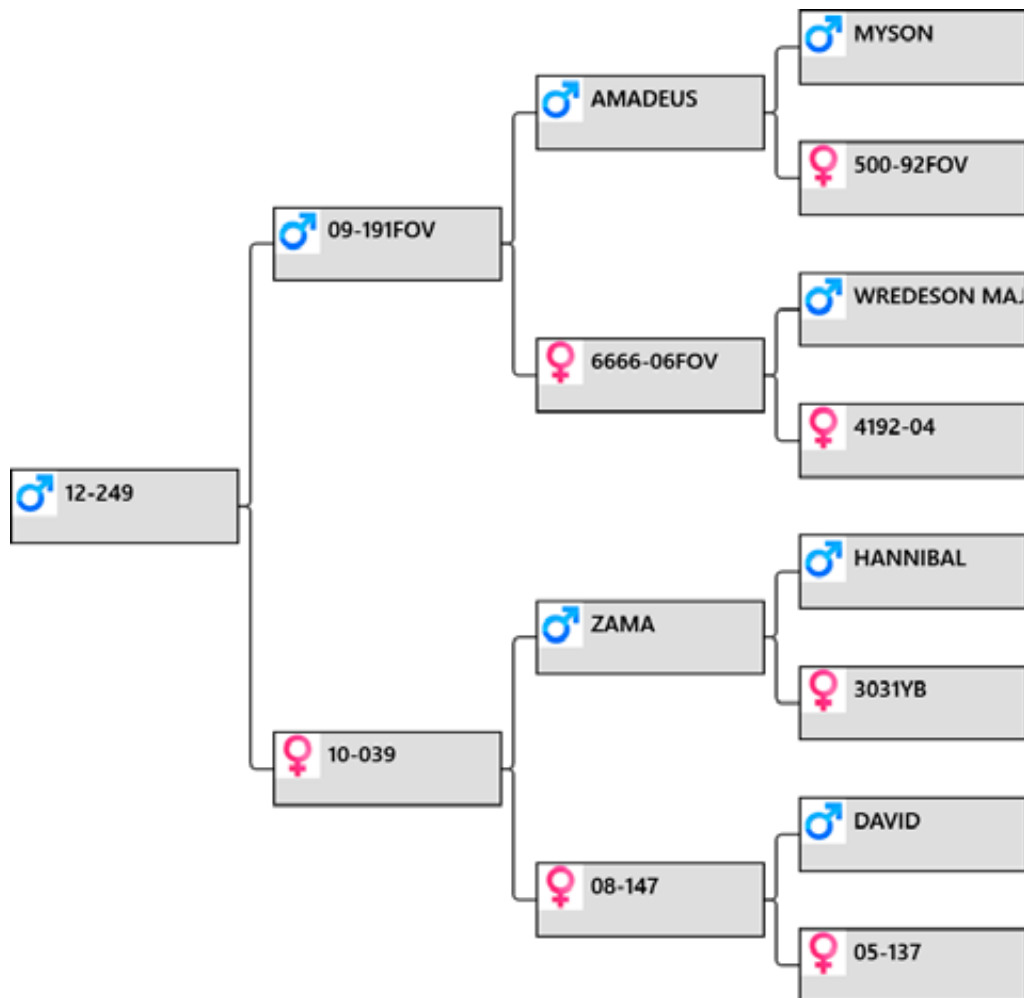

Biography:

Correct head clean and tidy weighing 6.05kg. Dam 39-10 is full sister to 61-10 dam of 188-10 10.35kg 3yr old national velvet champion. 137-05 dam of 2yr olds cutting 4.7kg and 6.85kg with last one sold to Alan Stewart. 3yr weight 15/12/15 210 kg.

Sale weight:

Price:

Buyer:



lot # 25 – 3yr sire stag



Animal: **12-001**

Birthdate: 2012

Weigh Date	Weight
26/03/2013	62 kg
21/01/2014	110 kg

Velvet Date	Weight	Grade
1/12/2015	6.16	
1/11/2014	4.65	

3yr Velvet weight: 6.16kg

Pedigree:

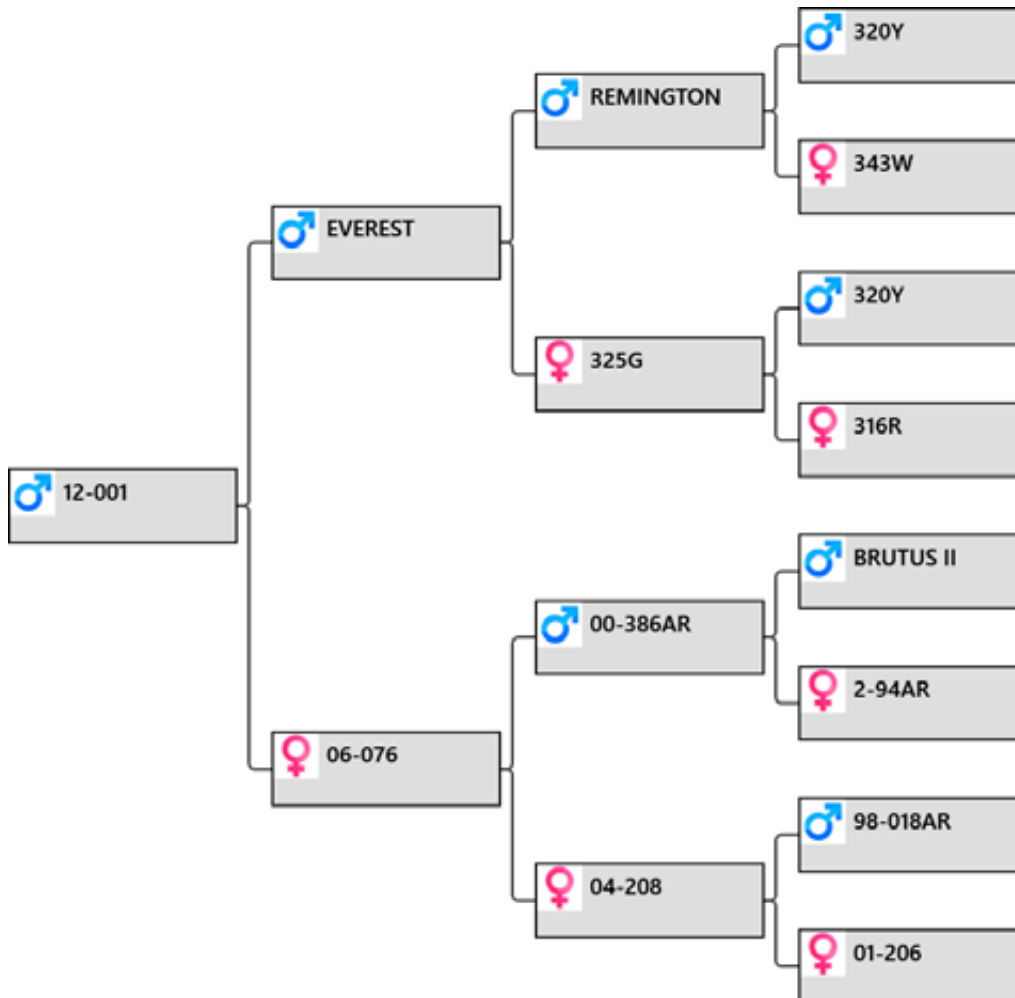

Biography:

Snags but still good head for last on offer.
3yr weight 244kg.

Sale weight:

Price:

Buyer:

lot # 26 – 2yr sire stag



Animal: **13-080**

Birthdate: 2013

<u>Weigh Date</u>	<u>Weight</u>
30/03/2014	72 kg

Pedigree:

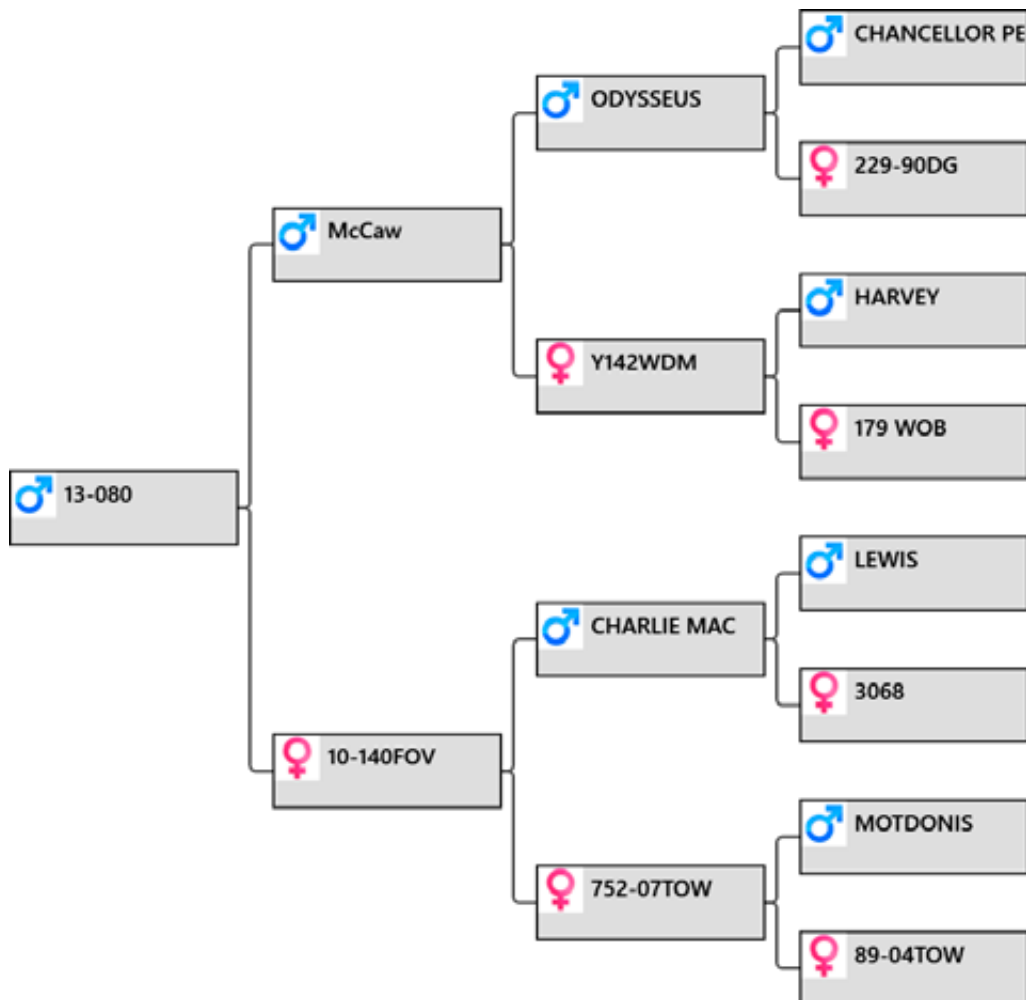

Biography:

80-13 2yr old growing out. Too early to tell at catalogue time but looks ok.

Sale weight:

Price:

Buyer:



lot # 27

5 straws of Everest semen

yearling hinds

Our yearling hinds are catalogued in tag order.

Some very good yearling hinds on offer with some being catalogued just because their dam has only produced females to date or male progeny has not reached 2yrs of age yet (so no sons to rank their velvet potential on).

lot # 40 – Yearling hind

Animal: **14-002**

Birthdate: 2014

Weigh Date	Weight
31/03/2015	66 kg
30/11/2015	88 kg

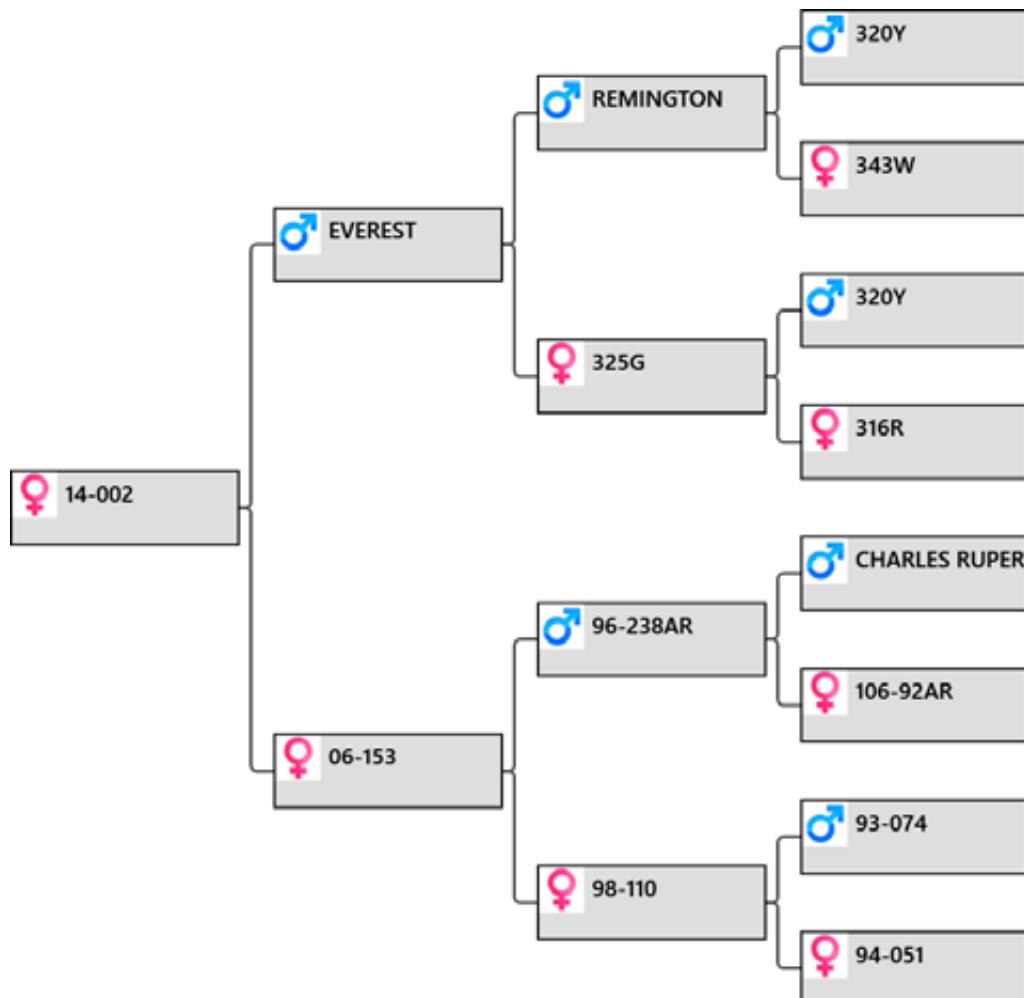
Pedigree:**Biography:**

Everest daughter with her dam 153-06 producing a 2yr son cutting 4.35kg. Everest dam of lot one and 3 Altrive National velvet champions.

Sale weight:

Price:

Buyer:



lot # 41 – Yearling hind

Animal: **14-006**

Birthdate: 2014

Weigh Date	Weight
31/03/2015	63 kg
30/11/2015	91 kg

Pedigree:

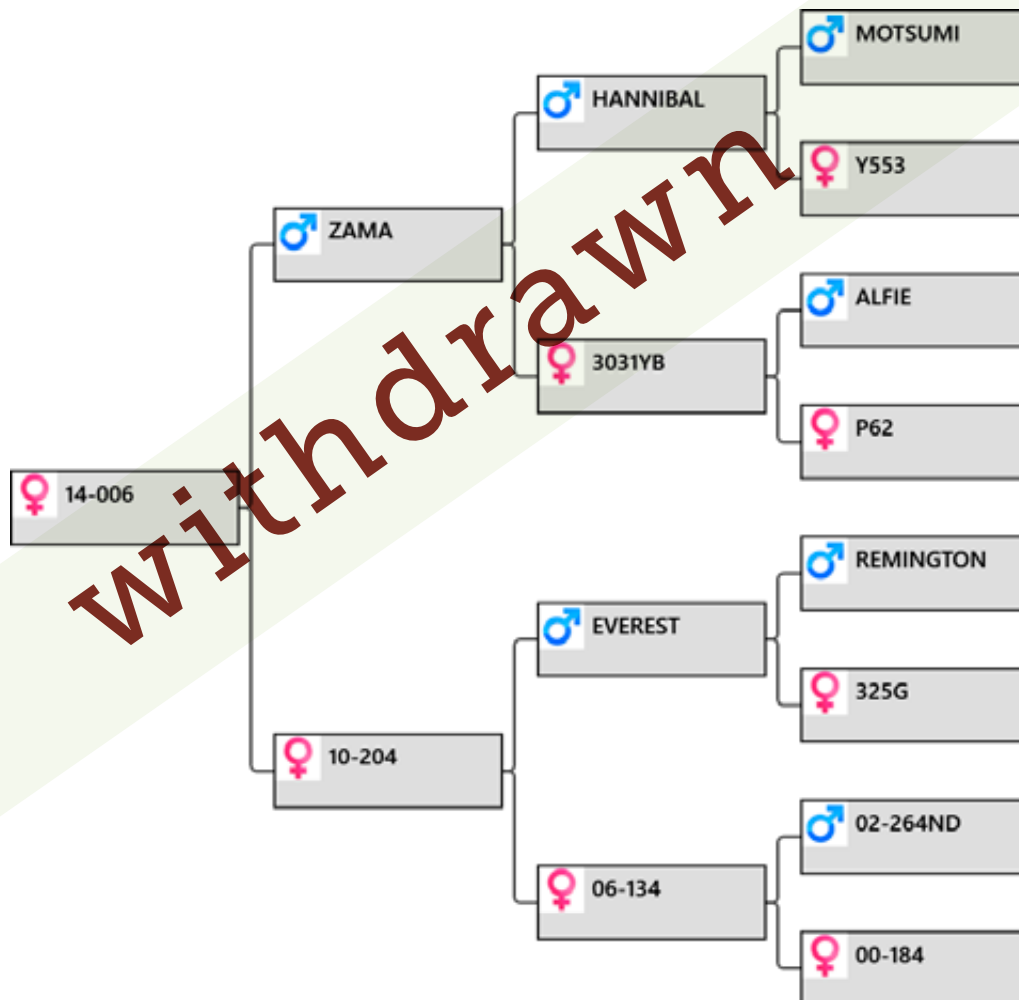

Biography:

Zama over Everest .Top breeding right back to 184-00 2yr sons at 4.6 and 4.65kg

Sale weight:

Price:

Buyer:

lot # 42 – Yearling hind

Animal: **14-013**

Birthdate: 2014

<u>Weigh Date</u>	<u>Weight</u>
31/03/2015	70 kg
30/11/2015	104 kg

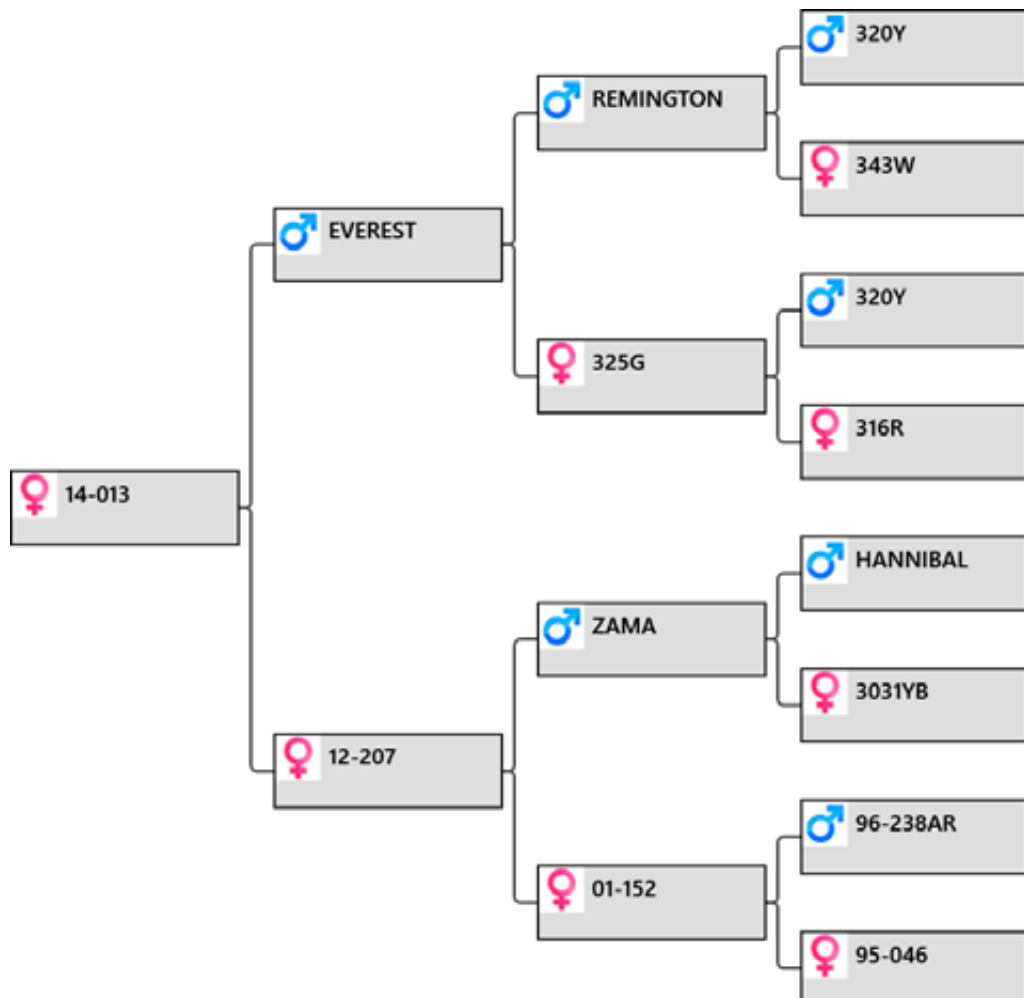
Pedigree:**Biography:**

The big spiker head in photo lot 10 is out of 184-12 ET sister to 207-12 dam of this yearling hind 13-14. Both 184-12 and 207-12 are full sisters to lot 10 198-12 and Victrix. 13-14 is sired by Everest as is the spiker 177-14.

We rank this hind and she will have to reach our reserve.

Sale weight:

Price:

Buyer:



lot # 43 – Yearling hind



performance recorded since 1985

Yearling Hind sale 2016

Animal: **14-018**

Birthdate: 2014

Weigh Date	Weight
31/03/2015	68 kg
30/11/2015	106 kg

Pedigree:

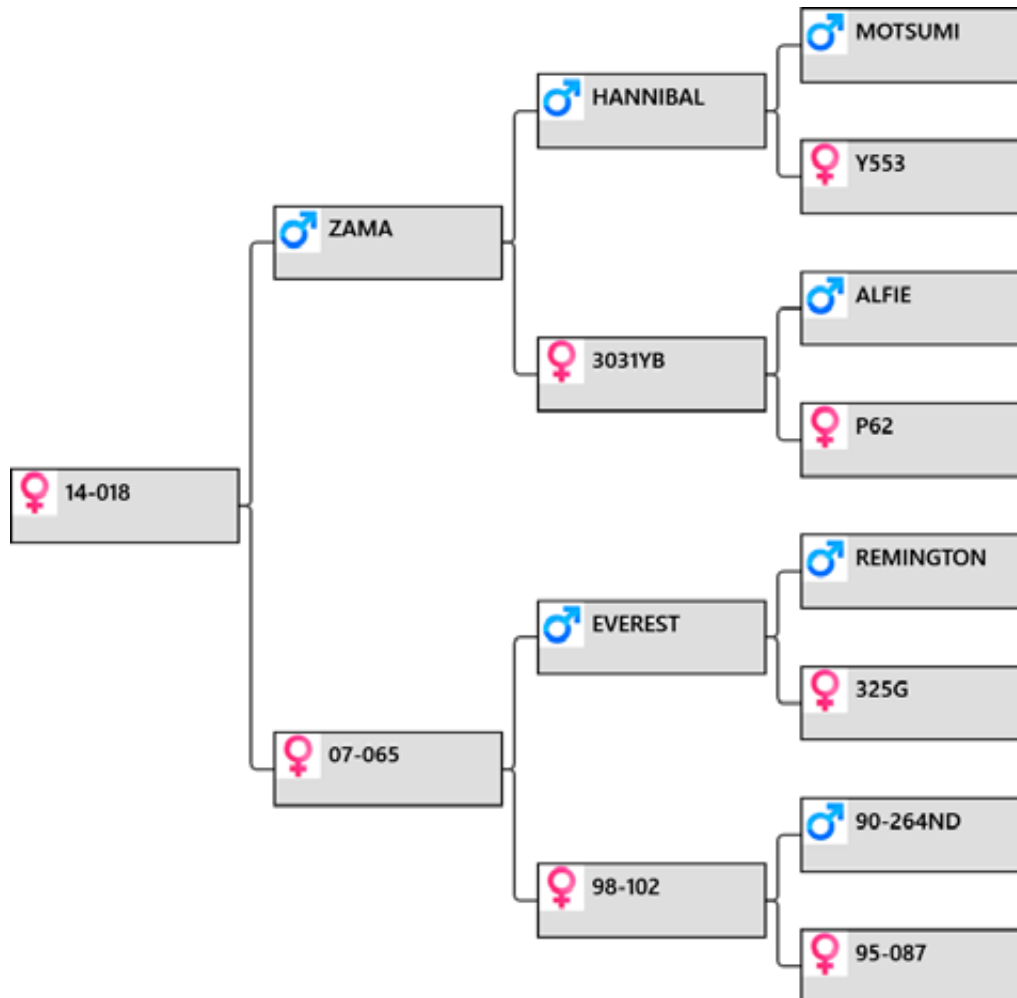

Biography:

Zama 12.25kg velvet over Everest 12.25kg velvet.

Sale weight:

Price:

Buyer:

lot # 44 – Yearling hind



Animal: **14-019**

Birthdate: 2014

Weigh Date	Weight
31/03/2015	72 kg
30/11/2015	96 kg

Pedigree:

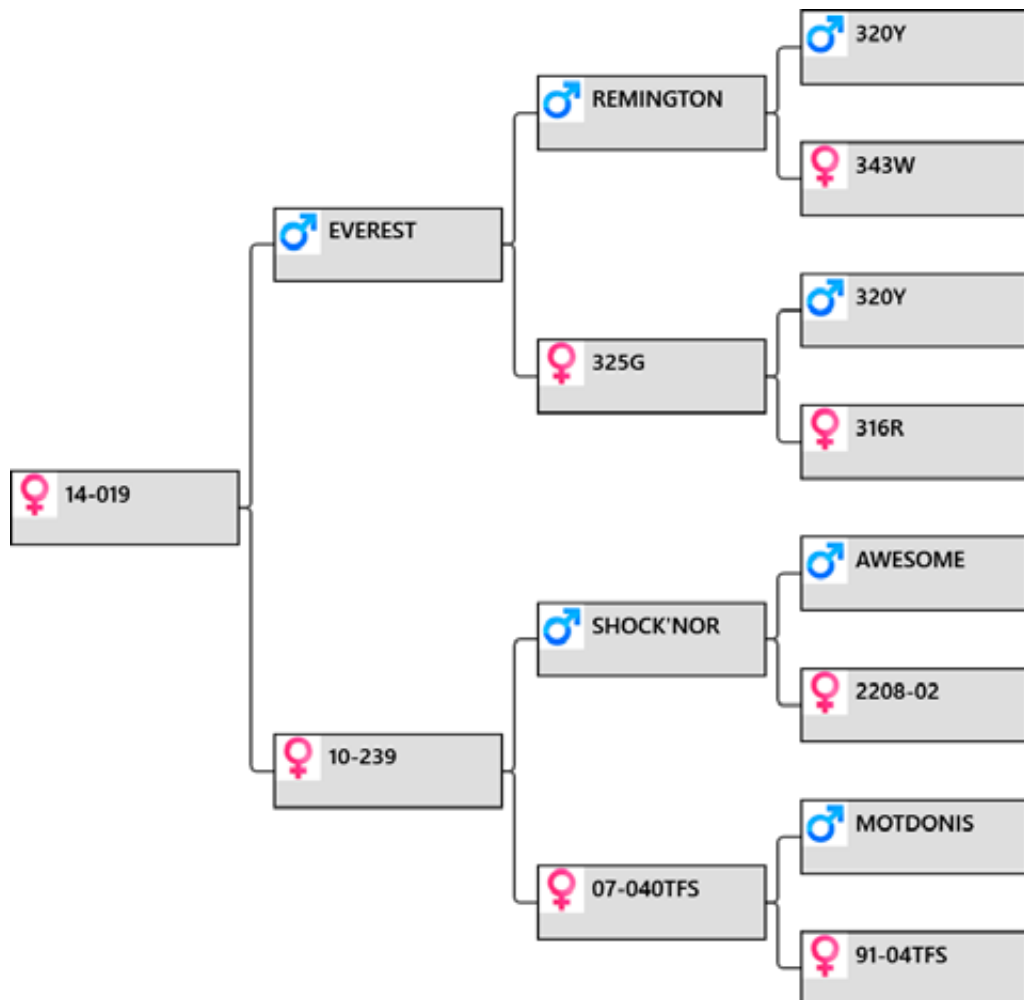

Biography:

Everest back to Tower Farms 40-07. She had a son in last years sale and one in this years

Sale weight:

Price:

Buyer:



lot # 45 – Yearling hind

Altrive Red Deer

performance recorded since 1985

Yearling Hind sale 2016

Animal: **14-026**

Birthdate: 2014

Weigh Date	Weight
31/03/2015	64 kg
30/11/2015	98 kg

Pedigree:

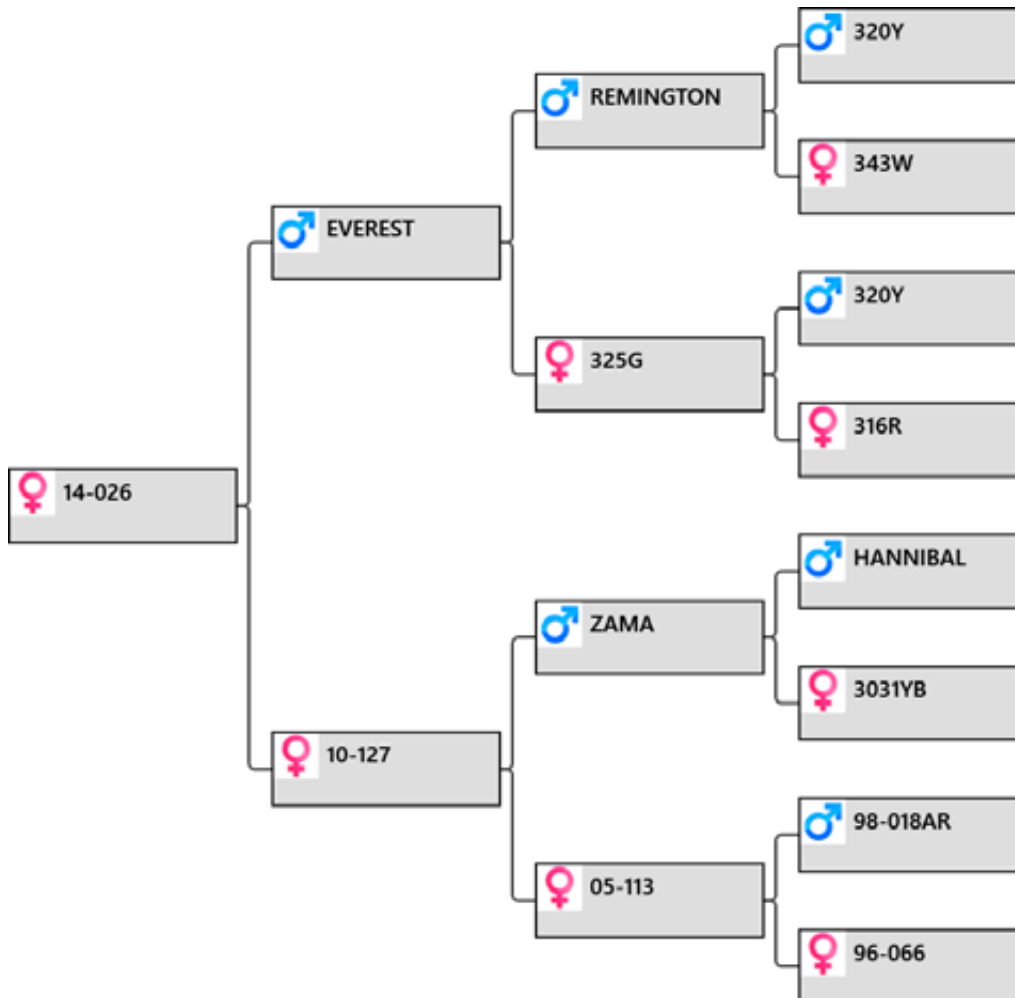

Biography:

127-10 three daughters and 113-05 a son 4.35kg @ 2yr

Sale weight:

Price:

Buyer:

lot # 46 – Yearling hind



Animal: **14-091**

Birthdate: 2014

<u>Weigh Date</u>	<u>Weight</u>
31/03/2015	50 kg
30/11/2015	80 kg

Pedigree:

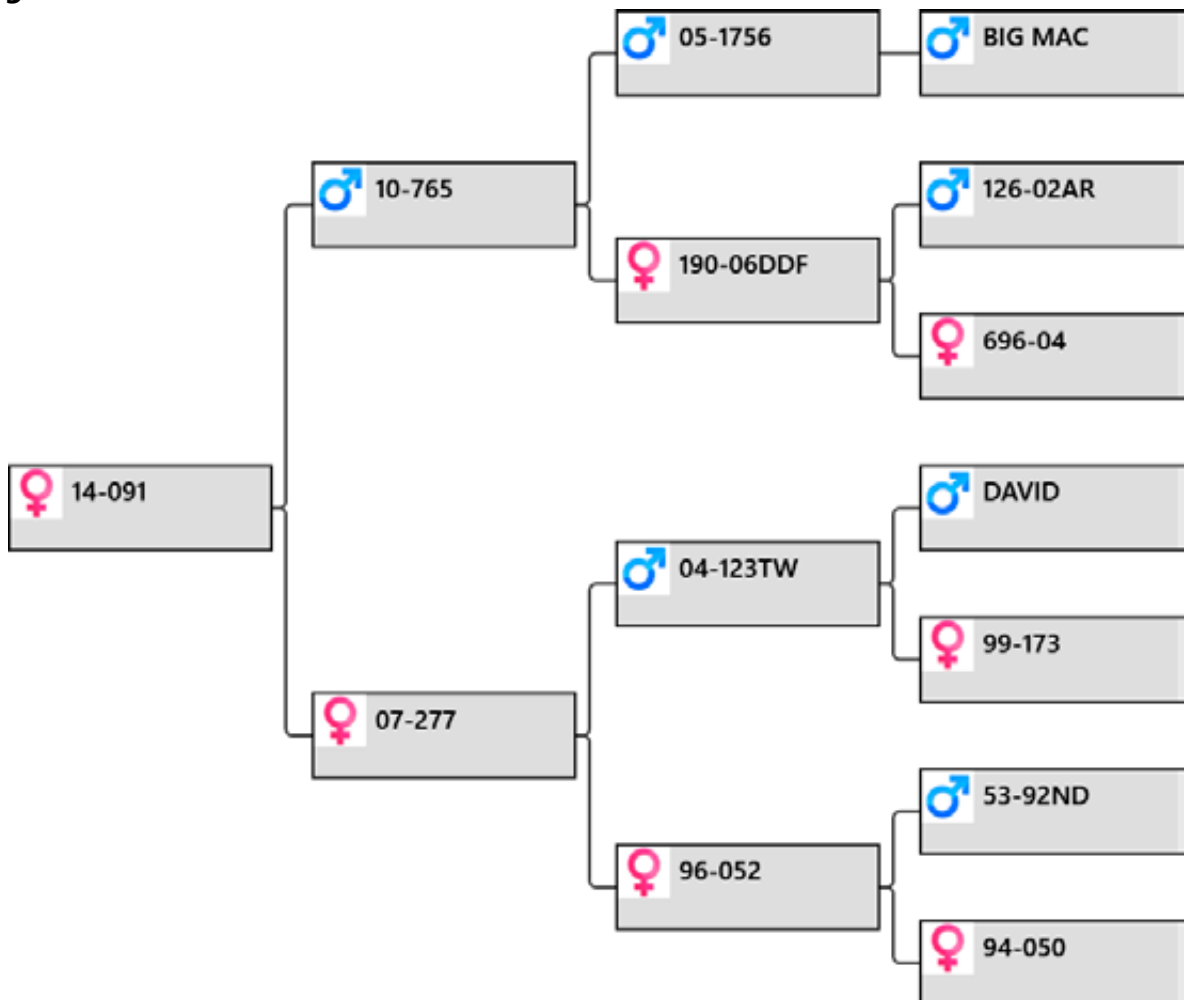

Biography:

765-10 8.1kg velvet 3 yr. 277-07 2yr son 4.35kg. 52-06 2yr sons @ 4.35 & 4.25kg

Sale weight:

Price:

Buyer:



lot # 47 – Yearling hind



performance recorded since 1985
Yearling Hind sale 2016

Animal: **14-097**

Birthdate: 2014

Weigh Date	Weight
31/03/2015	69 kg
30/11/2015	99 kg

Pedigree:

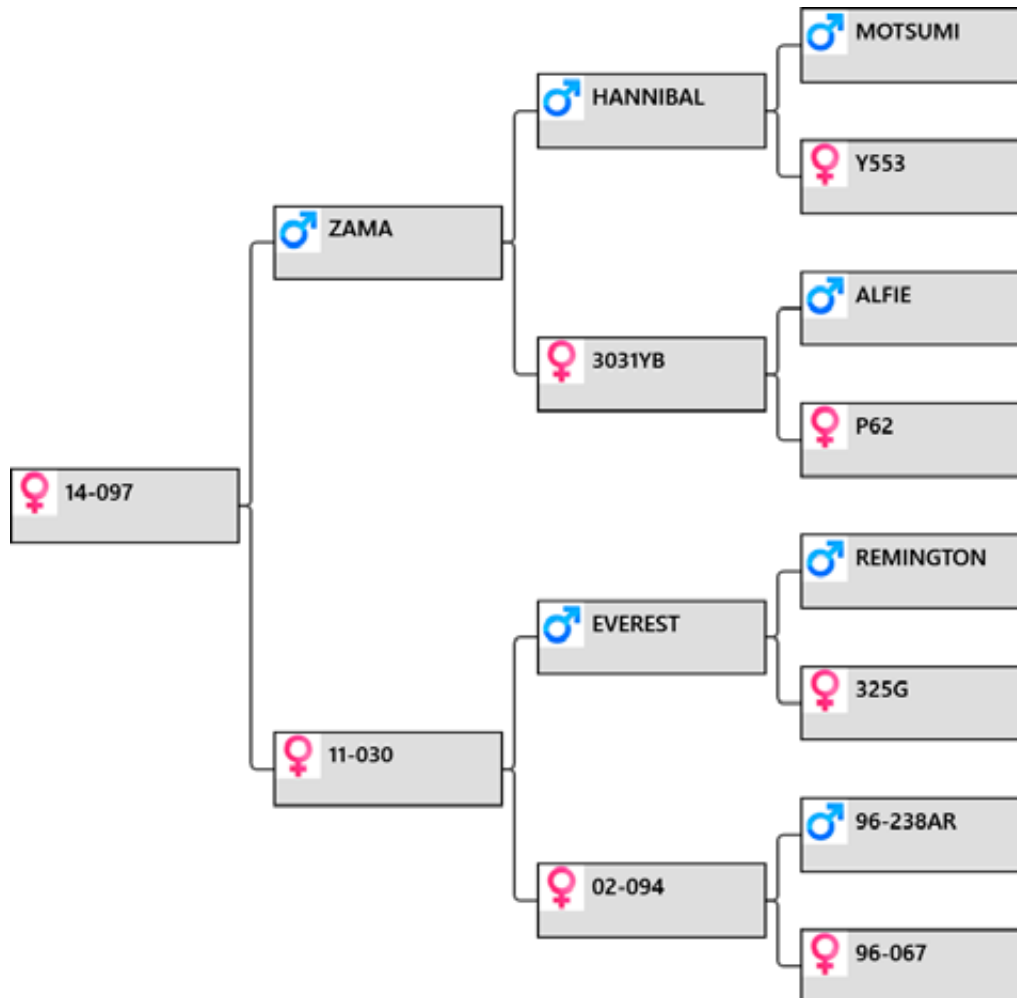

Biography:

Zama daughter back to 94-02 2yr sons at 4.8kg and 5.0kg

Sale weight:

Price:

Buyer:

lot # 48 – Yearling hind



Animal: **14-098**

Birthdate: 2014

<u>Weigh Date</u>	<u>Weight</u>
31/03/2015	64 kg
30/11/2015	80 kg

Pedigree:

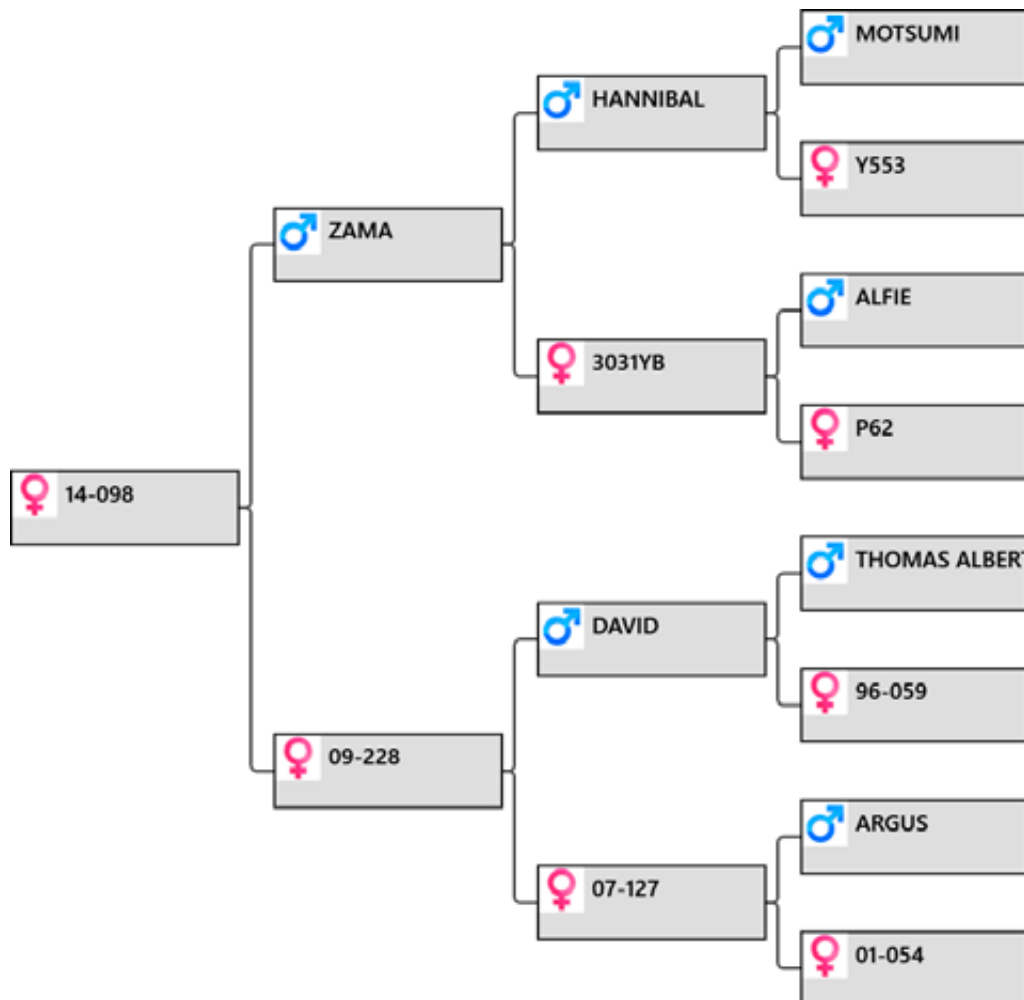

Biography:

228-09 5 daughters. 127-07 dam of lot 3 last year \$9500 and 54-01 son sold 2013 and twin sons sold \$4000 each.

Sale weight:

Price:

Buyer:



lot # 49 – Yearling hind



performance recorded since 1985

Yearling Hind sale 2016

Animal: **14-099**

Birthdate: 2014

Weigh Date	Weight
31/03/2015	64 kg
30/11/2015	89 kg

Pedigree:

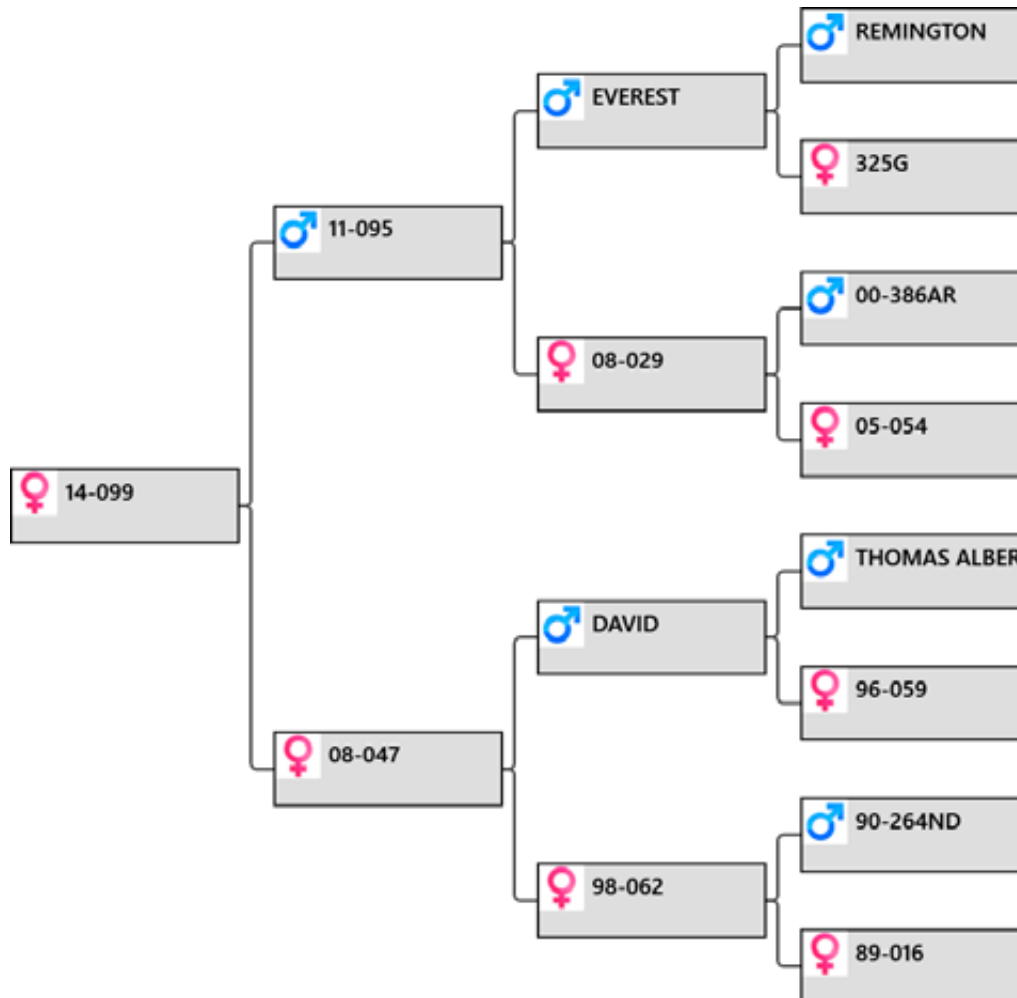

Biography:

95-11 8.6kg 3yr Everest son. 62-98 dam of good trophy.

Sale weight:

Price:

Buyer:

lot # 50 – Yearling hind



Animal: **14-107**

Birthdate: 2014

<u>Weigh Date</u>	<u>Weight</u>
31/03/2015	63 kg
30/11/2015	96 kg

Pedigree:

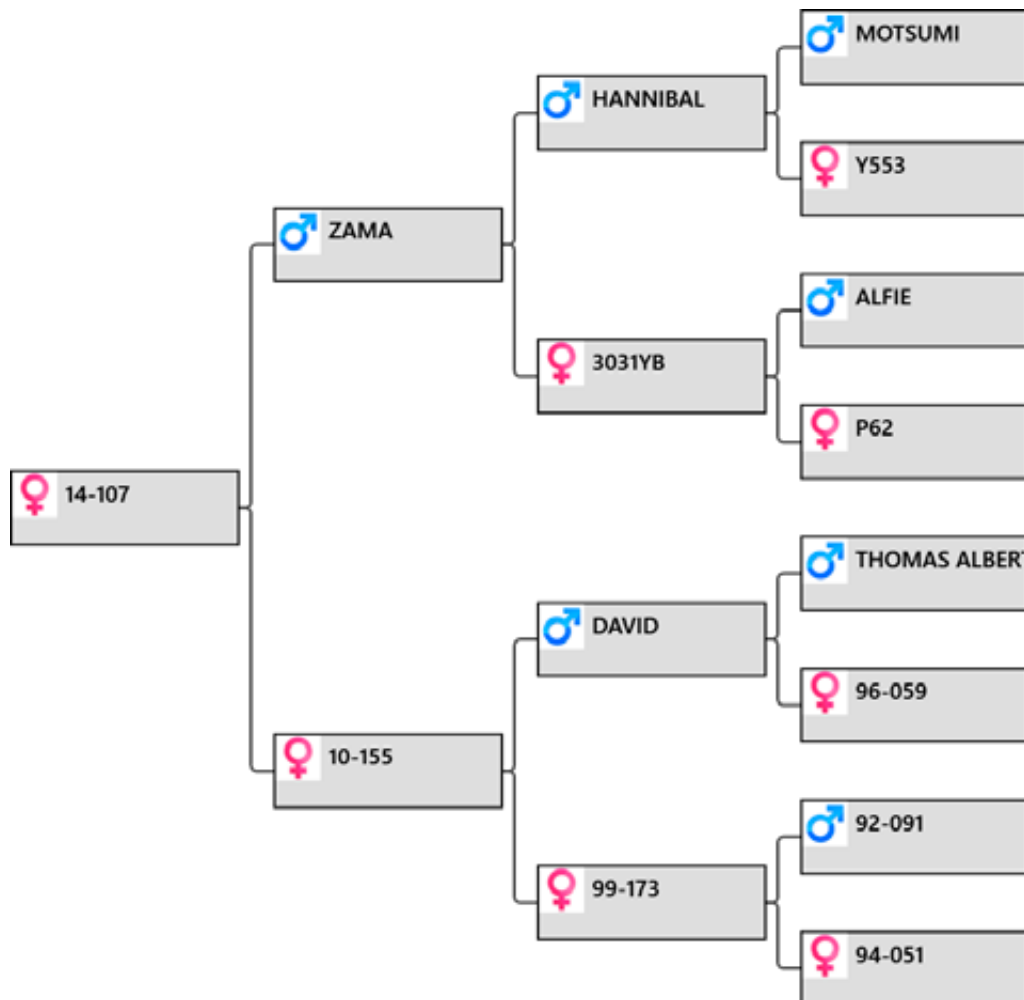

Biography:

Top velvet and trophy genetics. Zama over full sister to 123-04 502 IOA @ 4yr

Sale weight:

Price:

Buyer:



lot # 51 – Yearling hind



Altrive Red Deer
performance recorded since 1985
Yearling Hind sale 2016

Animal: **14-108**

Birthdate: 2014

Weigh Date	Weight
31/03/2015	65 kg
30/11/2015	97 kg

Pedigree:

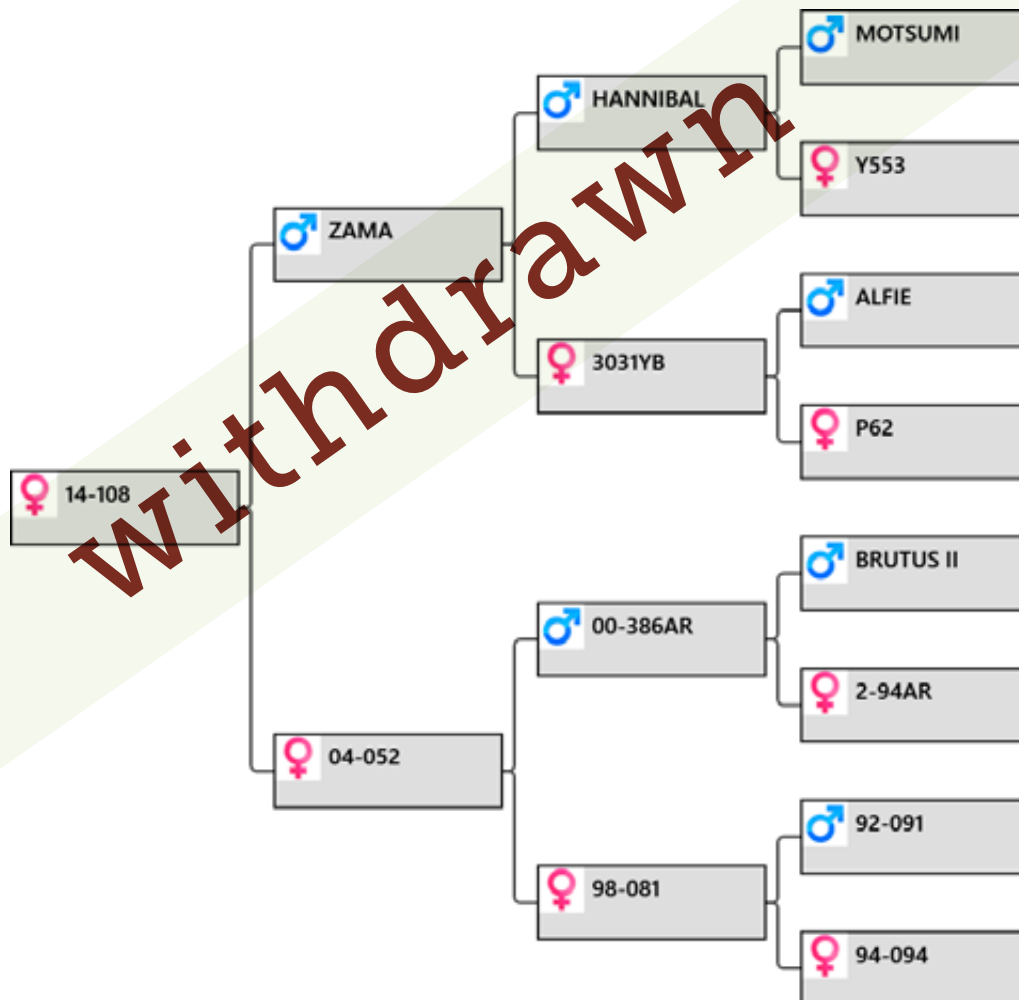

Biography:

Good velvet and trophy genetics again with velvet champ Zama back to 52-04 dam of trophy stag 450 SCI and 81-98 dam of 2yr old at 4kg.

Sale weight:

Price:

Buyer:

lot # 52 – Yearling hind



Animal: **14-115**

Birthdate: 2014

<u>Weigh Date</u>	<u>Weight</u>
31/03/2015	53 kg
30/11/2015	84 kg

Pedigree:

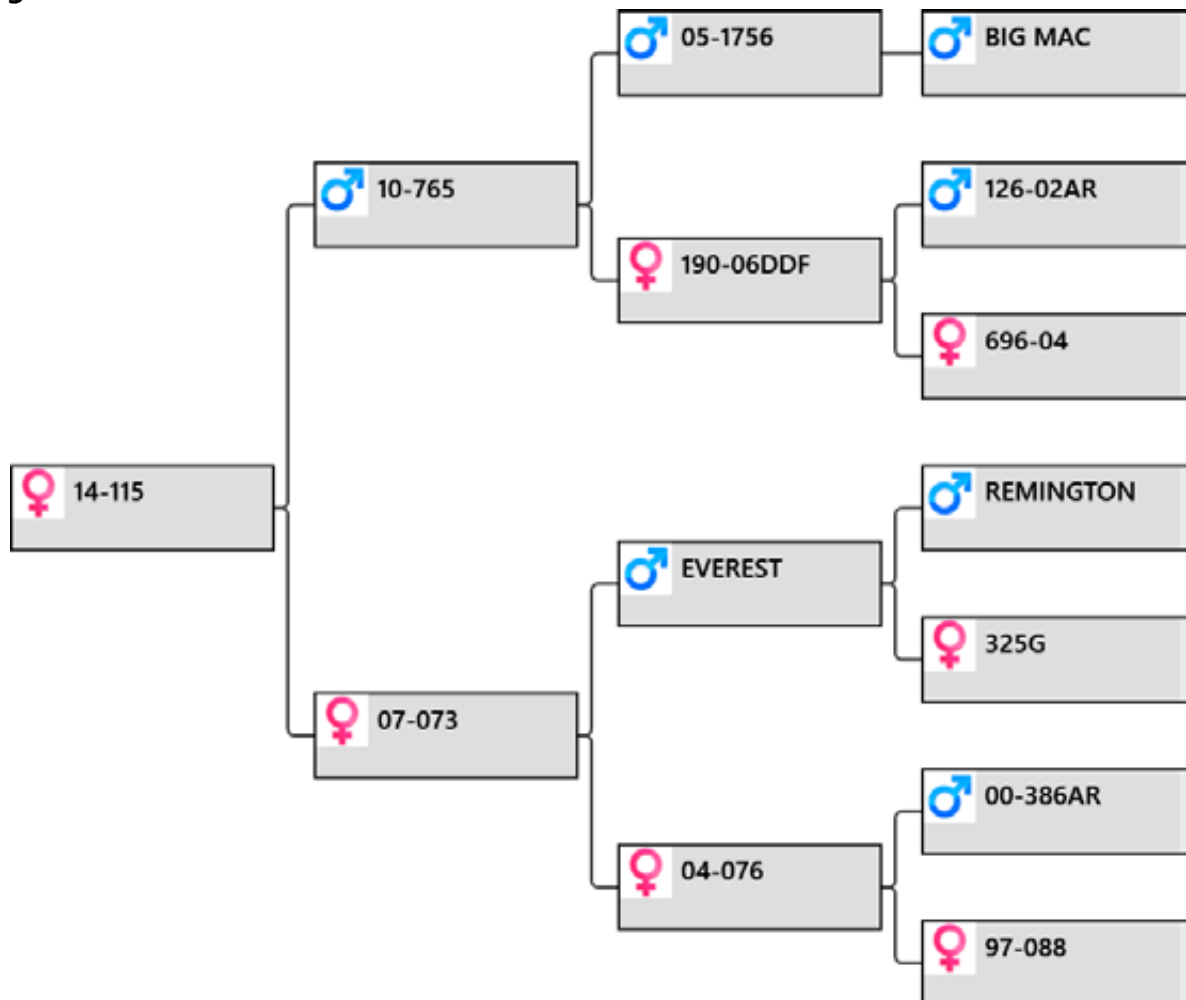

Biography:

765-10 7.8kg at 2yr over Everest. 76-04 dam of son sold \$4000 and old hind 88-97 dam of 4kg 2yr old

Sale weight:

Price:

Buyer:



lot # 53 – Yearling hind



performance recorded since 1985

Yearling Hind sale 2016

Animal: **14-116**

Birthdate: 2014

Weigh Date	Weight
30/11/2015	84 kg

Pedigree:

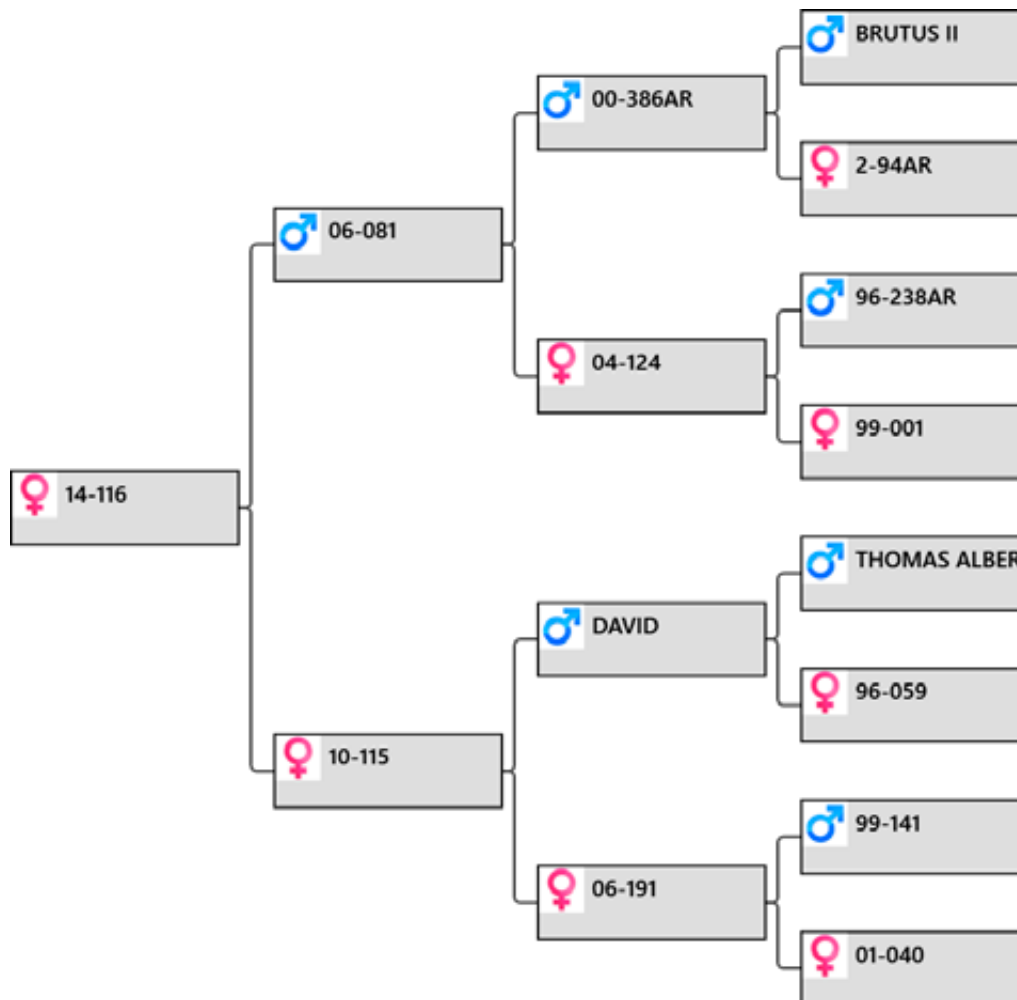

Biography:

Not many 81-06 daughters in catalogue. National 4yr champion and 2nd at 5yr . Cut a massive 17.2 kg SS head this year.

191-06 2yr son at 4.45kg and 40-01 had sons cutting 5.05 and 4.15 kg @2yr

Sale weight:

Price:

Buyer:

lot # 54 – Yearling hind



Animal: **14-126**

Birthdate: 2014

<u>Weigh Date</u>	<u>Weight</u>
31/03/2015	74 kg
30/11/2015	104 kg

Pedigree:

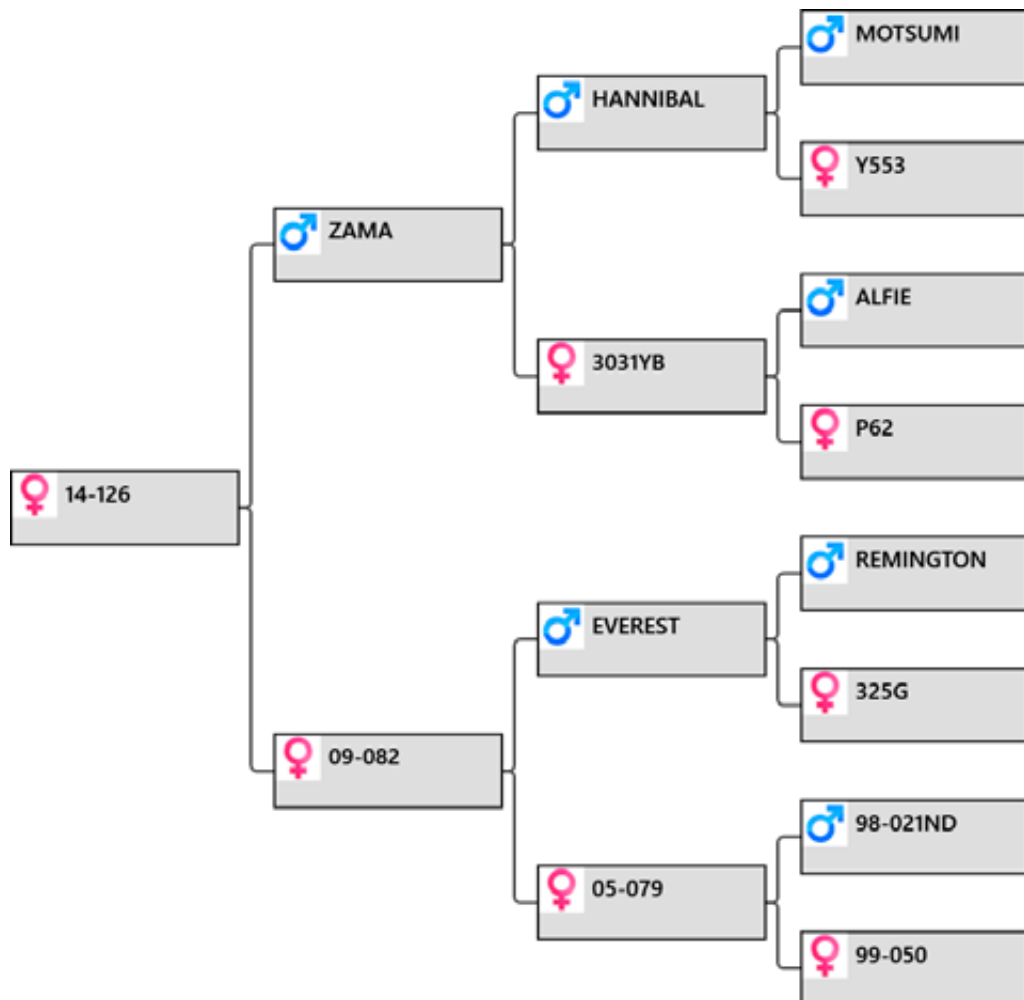

Biography:

Zama over Everest back to 50-99 2yr son @ 4.05 and 50-99 had a son sold as a sire.

Sale weight:

Price:

Buyer:



lot # 55 – Yearling hind



performance recorded since 1985
Yearling Hind sale 2016

Animal: **14-127**

Birthdate: 2014

<u>Weigh Date</u>	<u>Weight</u>
31/03/2015	58 kg
30/11/2015	82 kg

Pedigree:

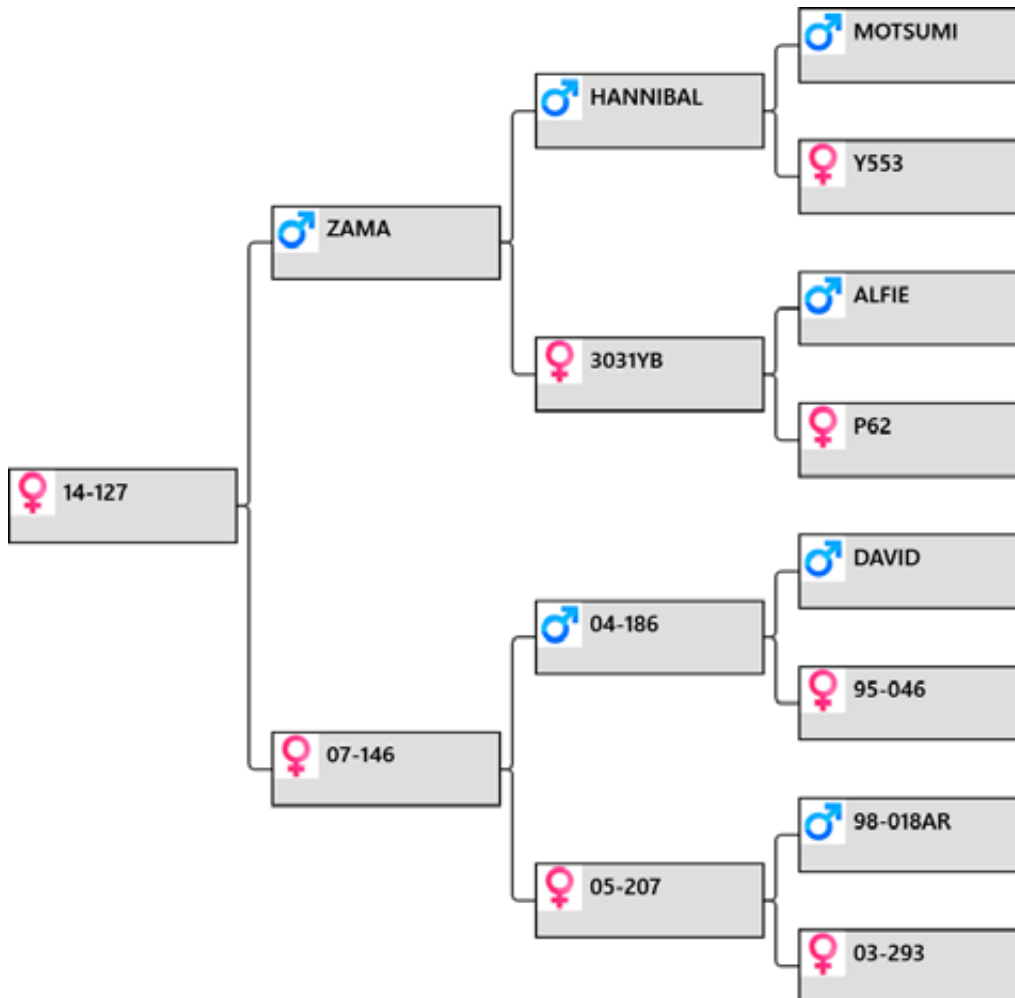

Biography:

Another daughter of Zama national velvet champion at 3yr and 6yr

Sale weight:

Price:

Buyer:

lot # 56 – Yearling hind



Animal: **14-129**

Birthdate: 2014

Weigh Date	Weight
31/03/2015	48 kg
30/11/2015	83 kg

Pedigree:

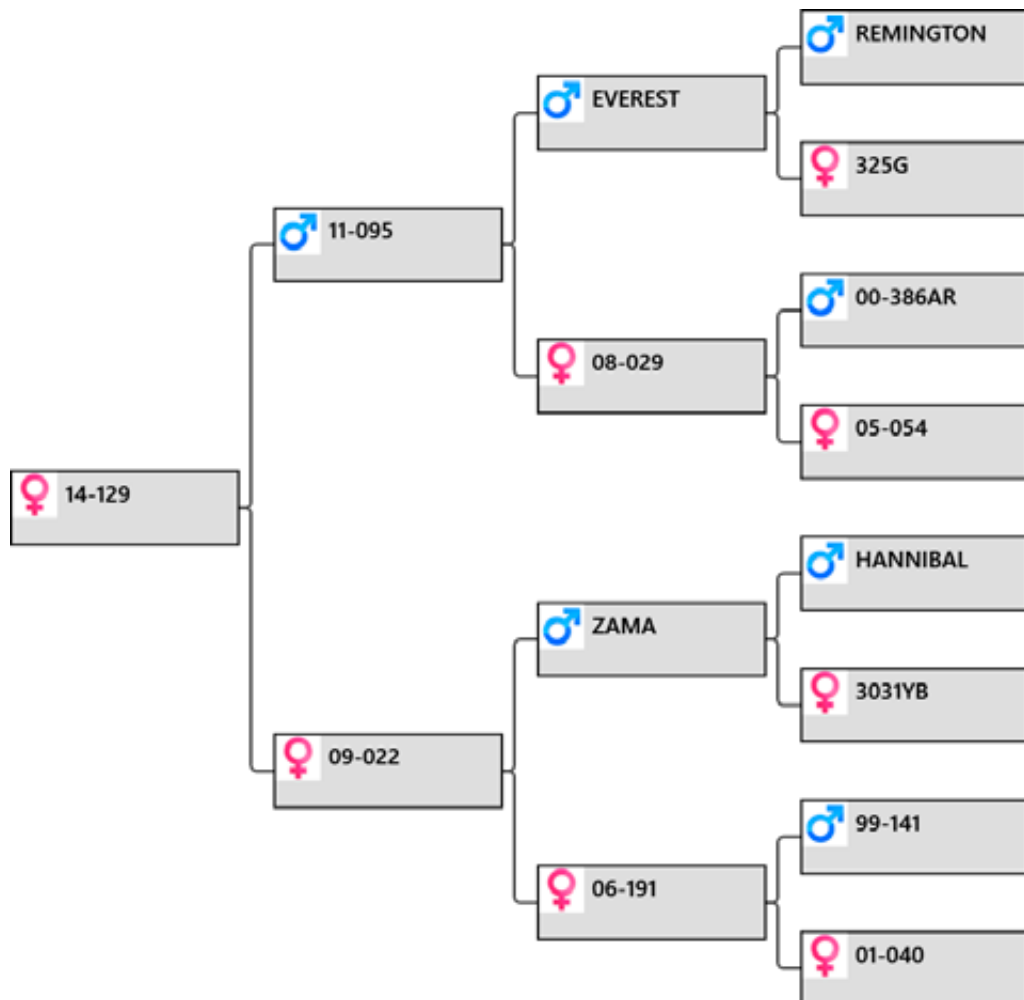

Biography:

Everest son 95-11 7.8 kg @2yr back to 191-06 dam of 2yr son cutting 4.45kg and 40-01 4.15kg and 5.05kg @ 2yr Plus good trophy stag.

Sale weight:

Price:

Buyer:



lot # 57 – Yearling hind



performance recorded since 1985

Yearling Hind sale 2016

Animal: **14-137**

Birthdate: 2014

Weigh Date	Weight
31/03/2015	72 kg
30/11/2015	107 kg

Pedigree:

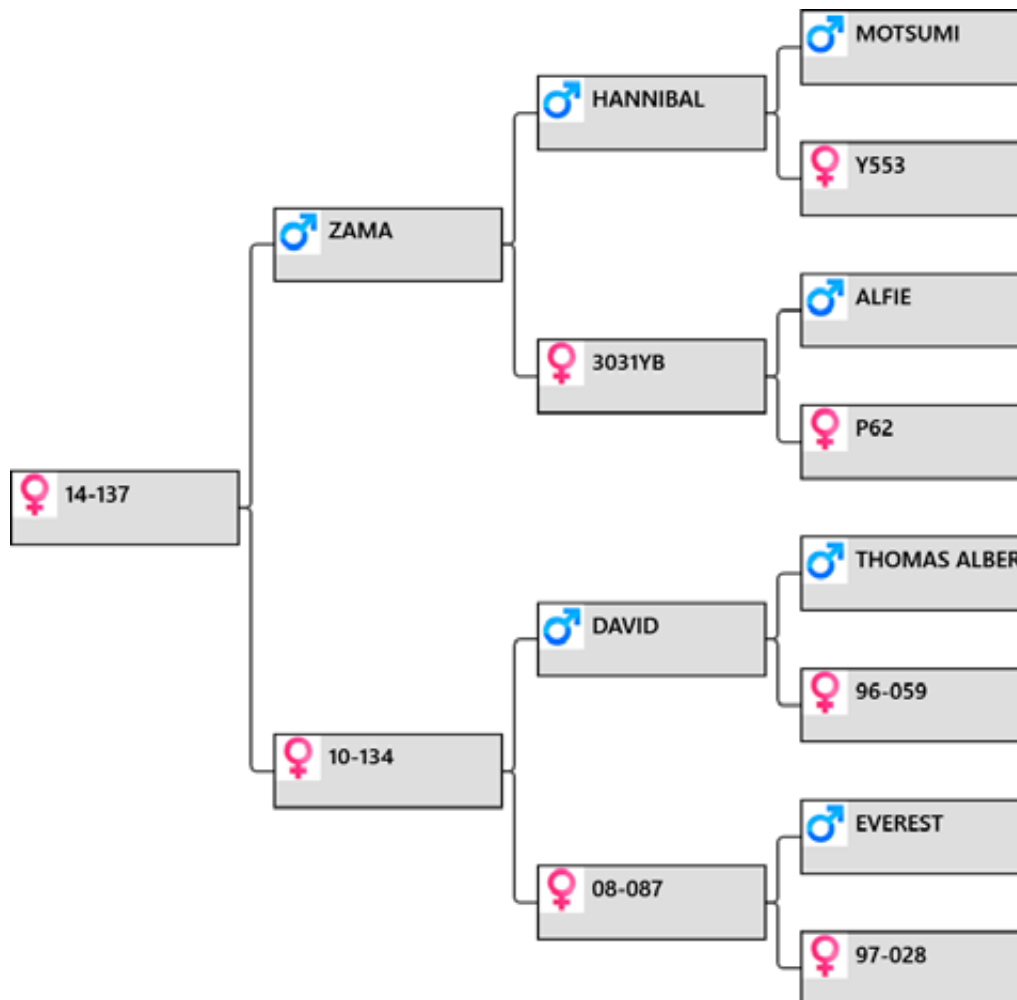

Biography:

Top Zama daughter with her dam 134-10 producing a daughter sold for \$2100 in 2014 sale. 87-08 dam of a son sold last year. 28-97 had a son sold as a sire.

Sale weight:

Price:

Buyer:

lot # 58 – Yearling hind



Animal: **14-143**

Birthdate: 2014

Weigh Date	Weight
31/03/2015	64 kg
30/11/2015	98 kg

Pedigree:

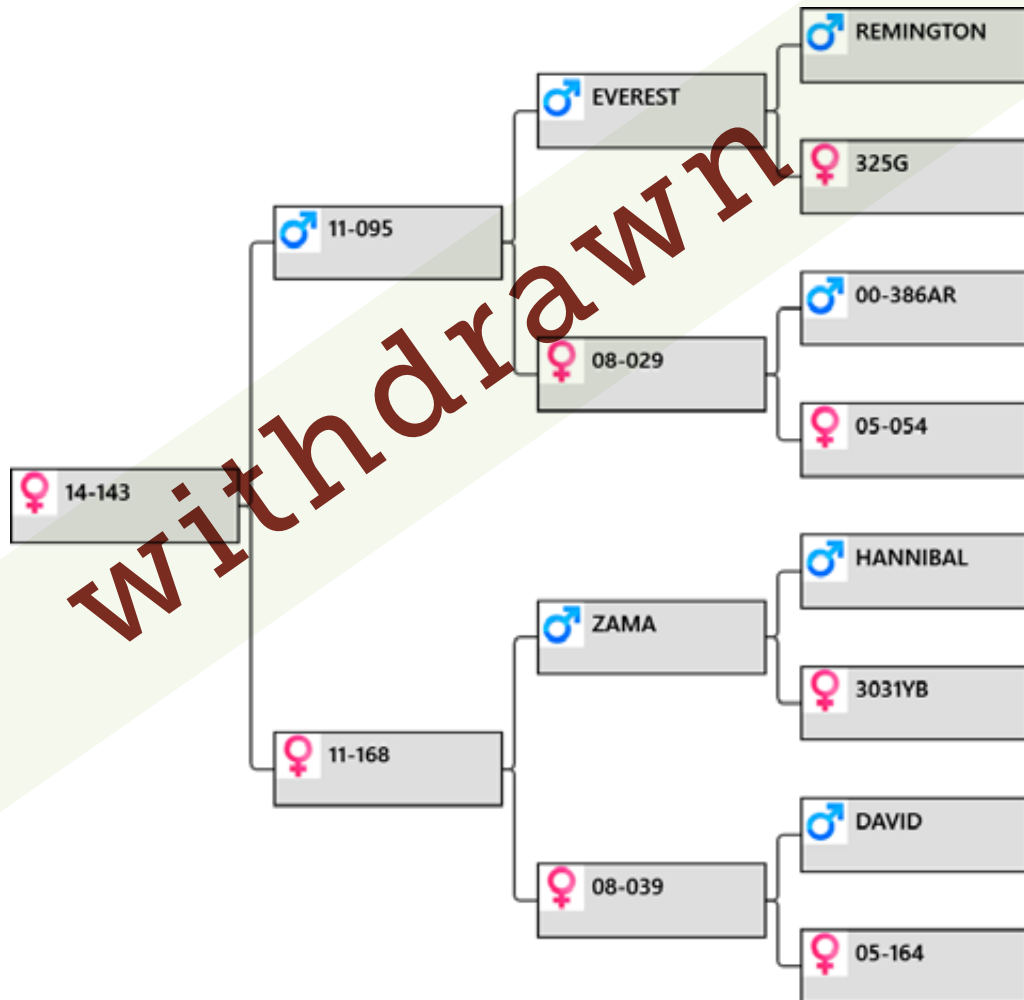

Biography:

95-11 top Everest son plus Zama back to 164-05 dam of 2yr son cutting 4kg

Sale weight:

Price:

Buyer:



lot # 59 – Yearling hind

Altrive Red Deer

performance recorded since 1985

Yearling Hind sale 2016

Animal: **14-144**

Birthdate: 2014

Weigh Date	Weight
31/03/2015	63 kg
30/11/2015	89 kg

Pedigree:

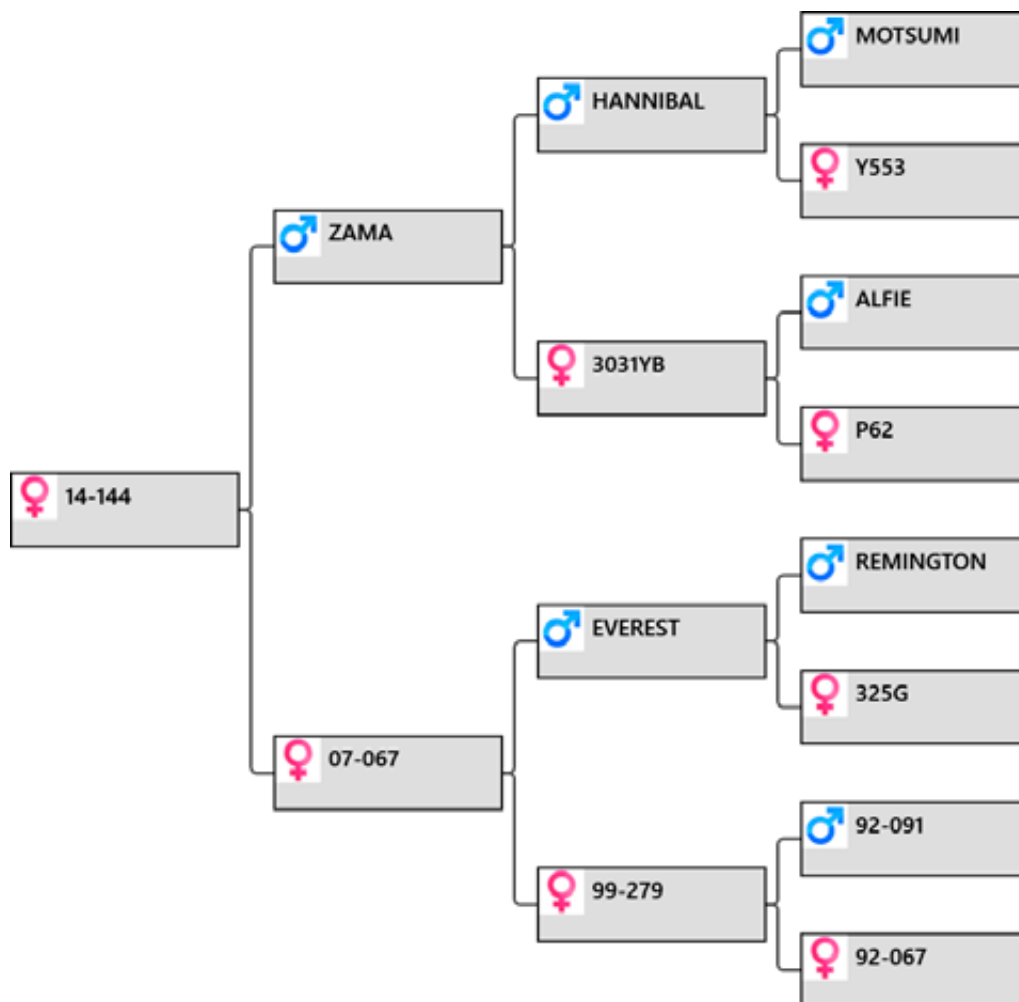

Biography:

Zama over Everest sire of our national 3yr champion 188-10 10.35kg

Sale weight:

Price:

Buyer:

lot # 60 – Yearling hind



Animal: **14-146**

Birthdate: 2014

<u>Weigh Date</u>	<u>Weight</u>
31/03/2015	63 kg
30/11/2015	94 kg

Pedigree:

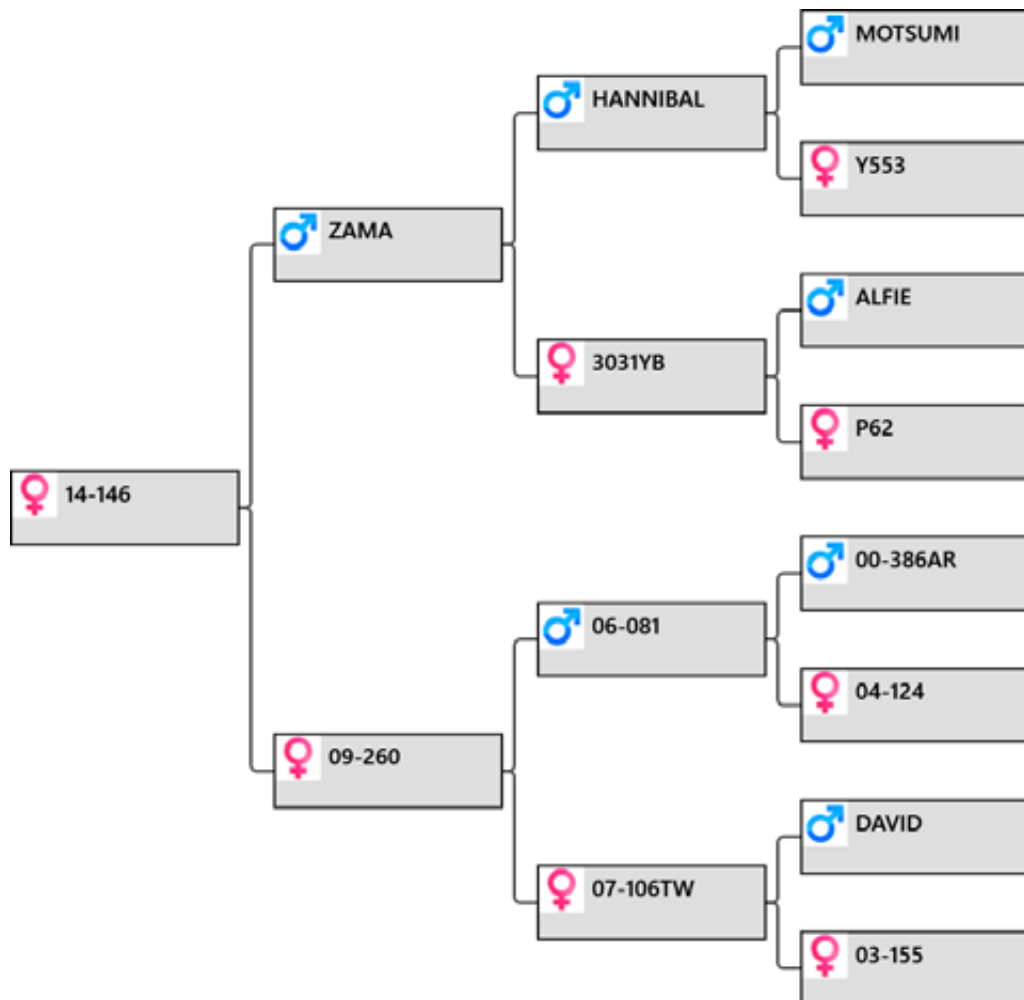

Biography:

Top hind, Zama over 81-06 velvet champion. 260-09 had a daughter sold 2014 for \$2100. 155-03 sons sold 2013 & 2014 sales.

Sale weight:

Price:

Buyer:



lot # 61 – Yearling hind



performance recorded since 1985

Yearling Hind sale 2016

Animal: **14-153**

Birthdate: 2014

Weigh Date **Weight**

31/03/2015 56 kg

Pedigree:

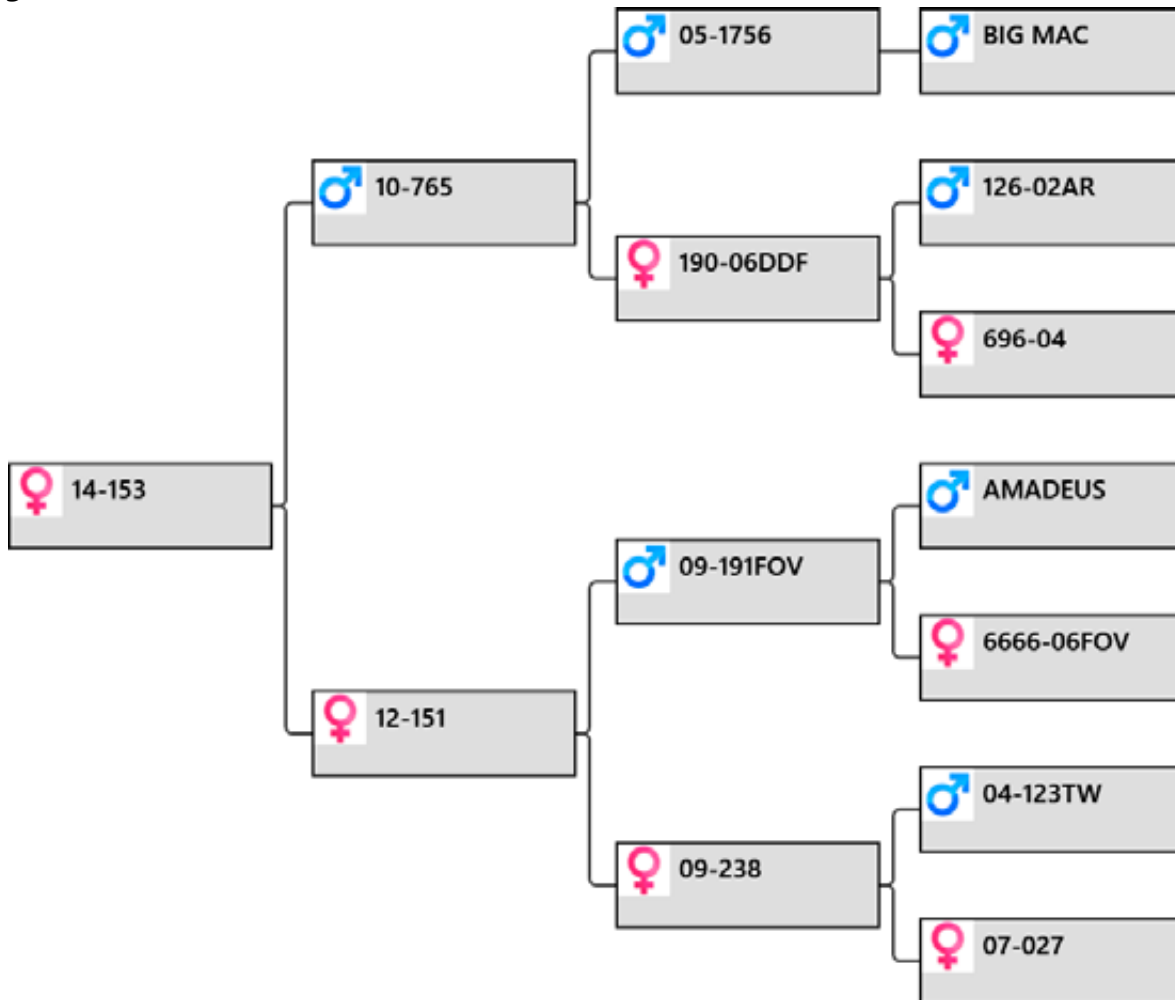

Biography:

765-10 over Fov 191-09 sire of lot 6 216-12 7.4kg. 238-09 dam of stag cutting 4.75kg at 2yr.
27-07 dam of 2yr old cutting 5.4kg.

Sale weight:

Price:

Buyer:

lot # 62 – Yearling hind



Animal: **14-157**

Birthdate: 2014

Weigh Date	Weight
31/03/2015	53 kg
30/11/2015	94 kg

Pedigree:

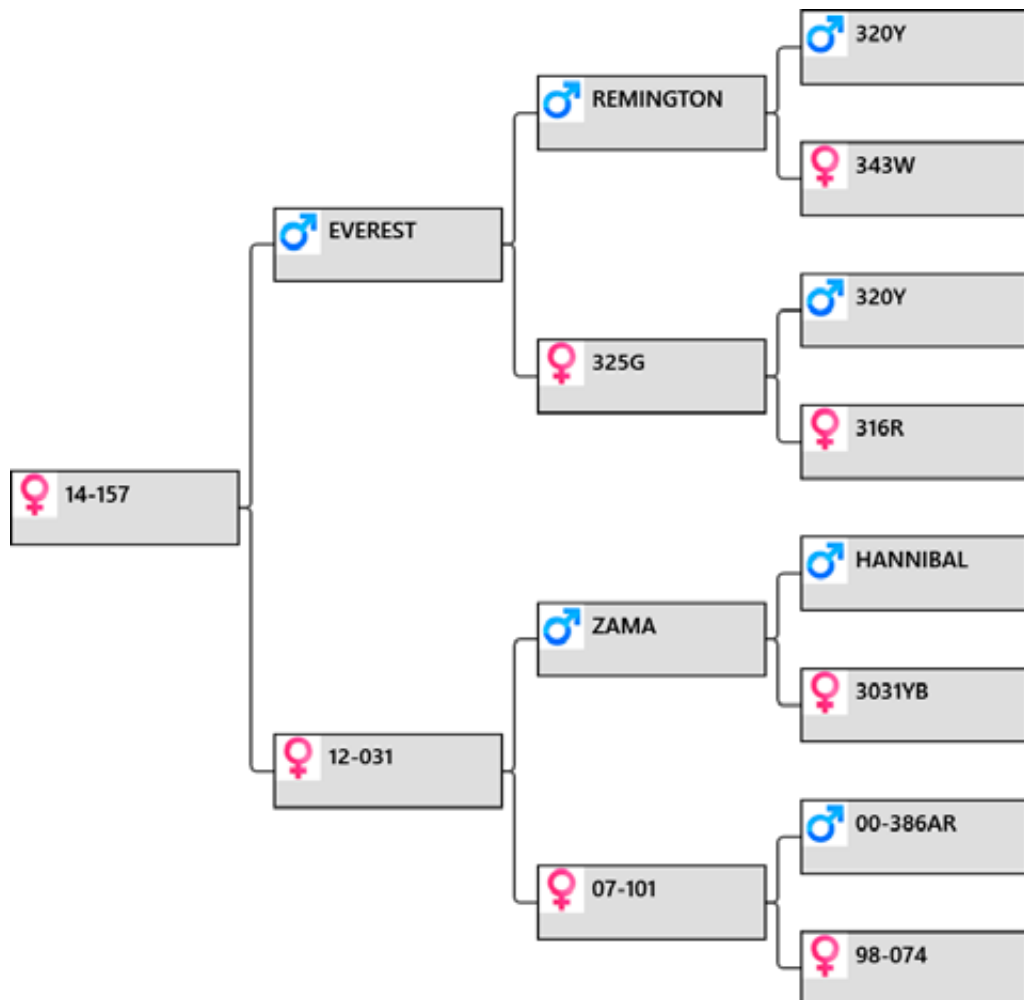

Biography:

Everest over Zama with 101-07 producing a son cutting 4.05 kg @2yr

Sale weight:

Price:

Buyer:



lot # 63 – Yearling hind



performance recorded since 1985

Yearling Hind sale 2016

Animal: **14-160**

Birthdate: 2014

Weigh Date	Weight
31/03/2015	57 kg
30/11/2015	89 kg

Pedigree:

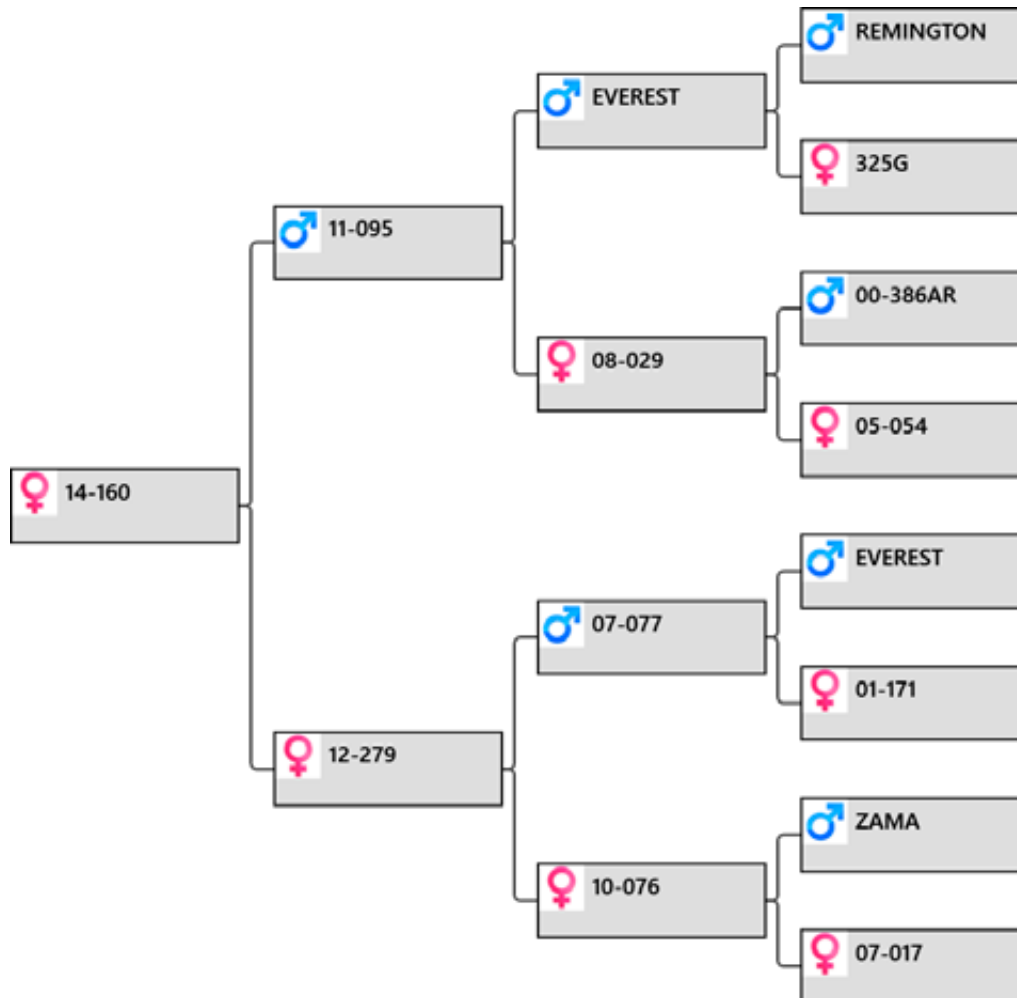

Biography:

2 top Everest sons plus zama

Sale weight:

Price:

Buyer:

lot # 64 – Yearling hind



Animal: **14-164**

Birthdate: 2014

<u>Weigh Date</u>	<u>Weight</u>
31/03/2015	46 kg
30/11/2015	82 kg

Pedigree:

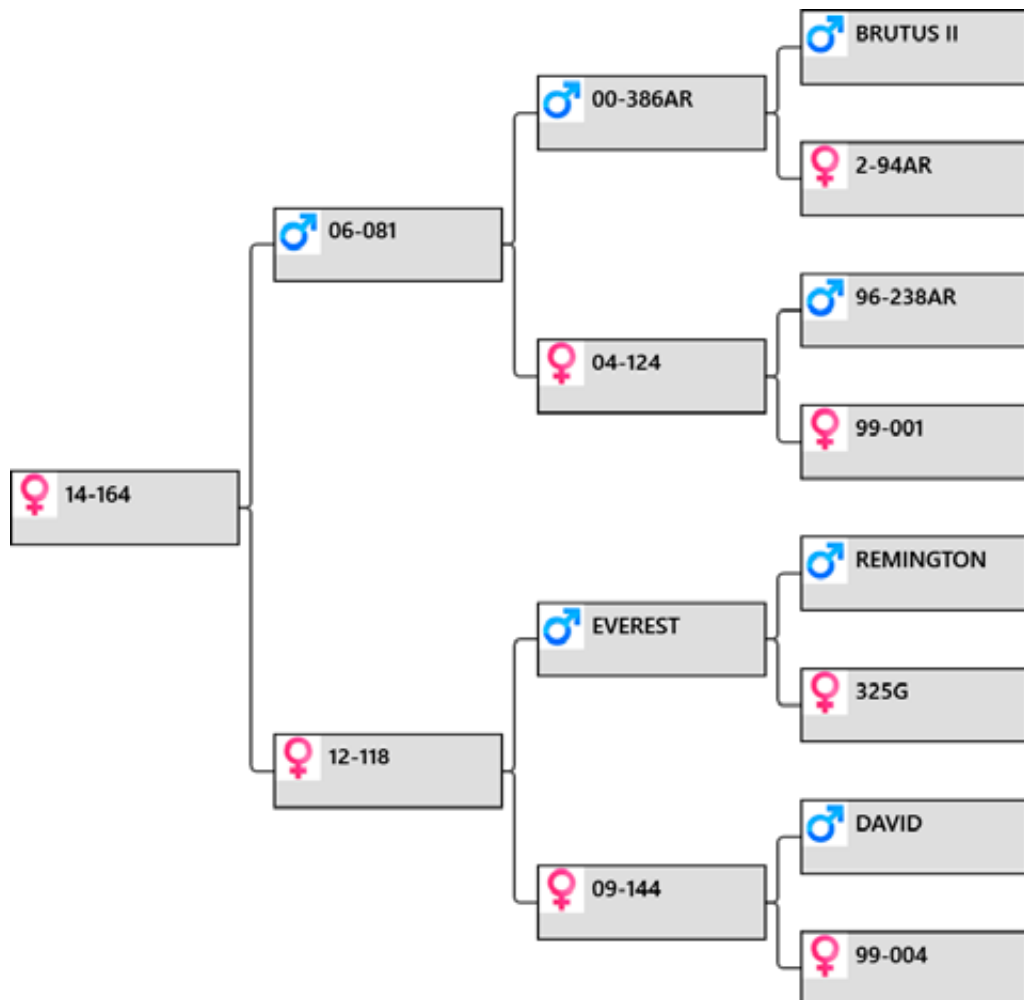

Biography:

81-06 cut a massive 17.2 kg SS this year plus Everest 12.25kg and David 11kg

Sale weight:

Price:

Buyer:



lot # 65 – Yearling hind



performance recorded since 1985

Yearling Hind sale 2016

Animal: **14-167**

Birthdate: 2014

Weigh Date	Weight
31/03/2015	56 kg
30/11/2015	87 kg

Pedigree:

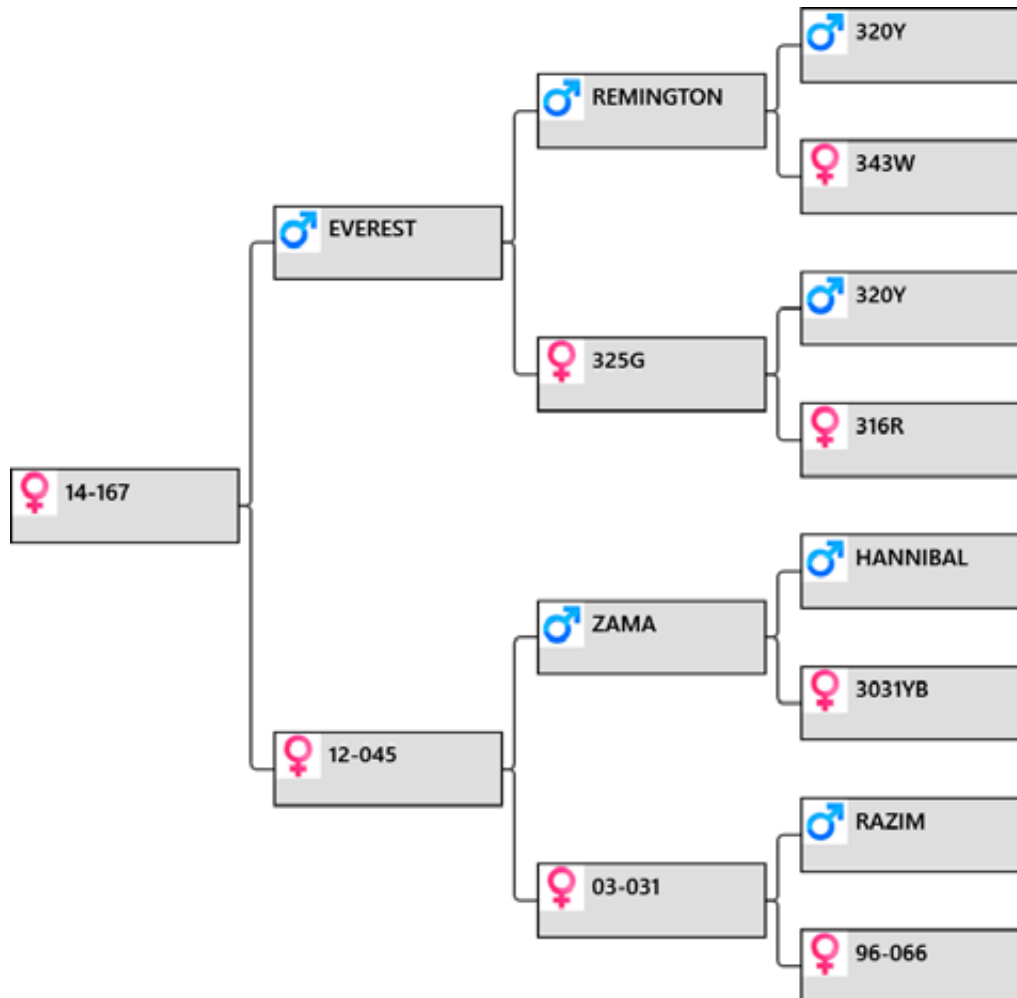

Biography:

Zama over a Razim daughter who is the dam of 110-08 8kg at 3yr (deceased)

Sale weight:

Price:

Buyer:

lot # 66 – Yearling hind



Animal: **14-169**

Birthdate: 2014

<u>Weigh Date</u>	<u>Weight</u>
31/03/2015	58 kg
30/11/2015	84 kg

Pedigree:

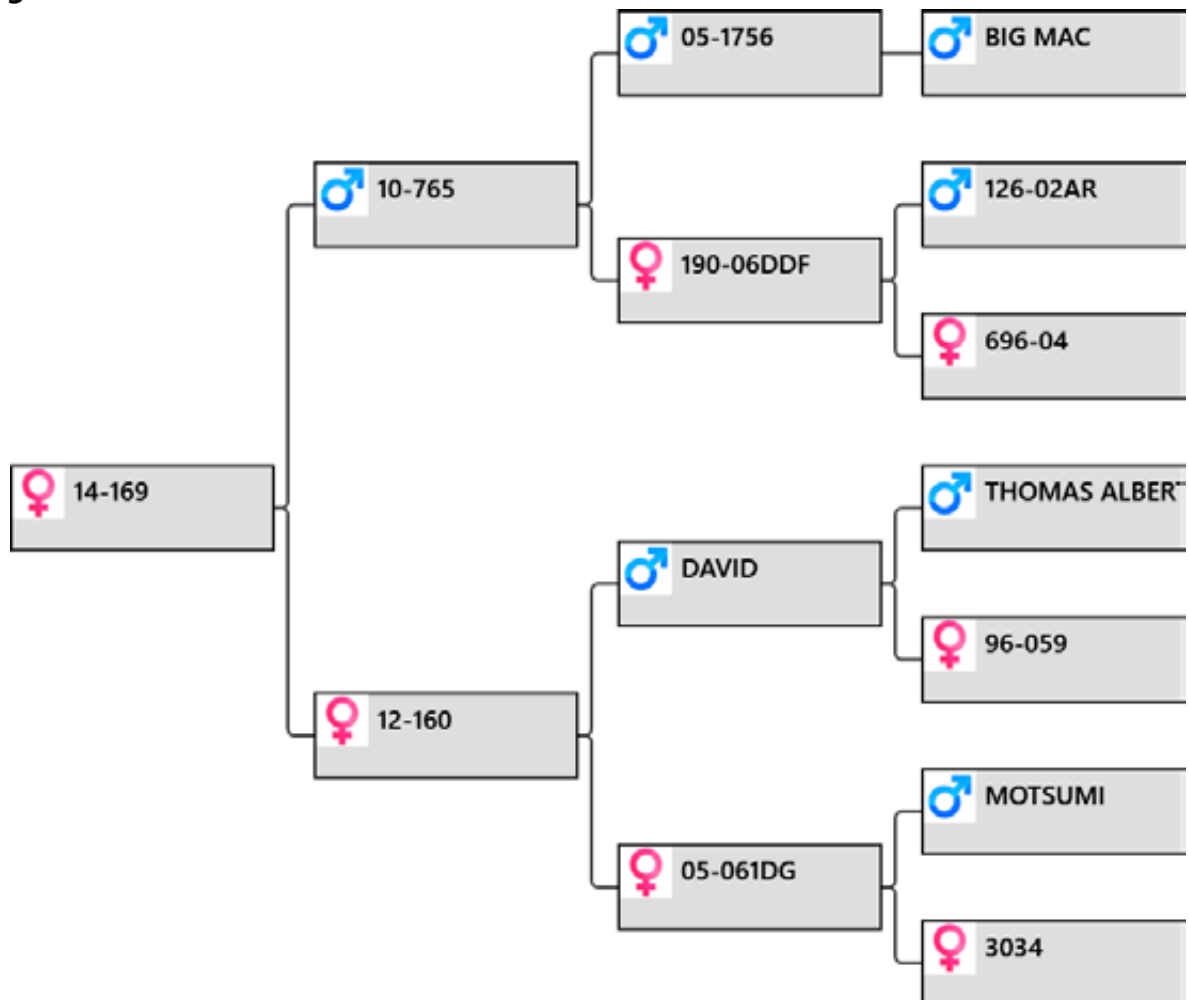

Biography:

765-10 has first 2yr olds this year and is breeding well with his best 2yr old son as at 4/12/15 cutting 5.8kg and only one under 4kg from the 8 cut to date.

Sale weight:

Price:

Buyer:



lot # 67 – Yearling hind



performance recorded since 1985
Yearling Hind sale 2016

Animal: **14-176**

Birthdate: 2014

Weigh Date	Weight
31/03/2015	64 kg
30/11/2015	85 kg

Pedigree:

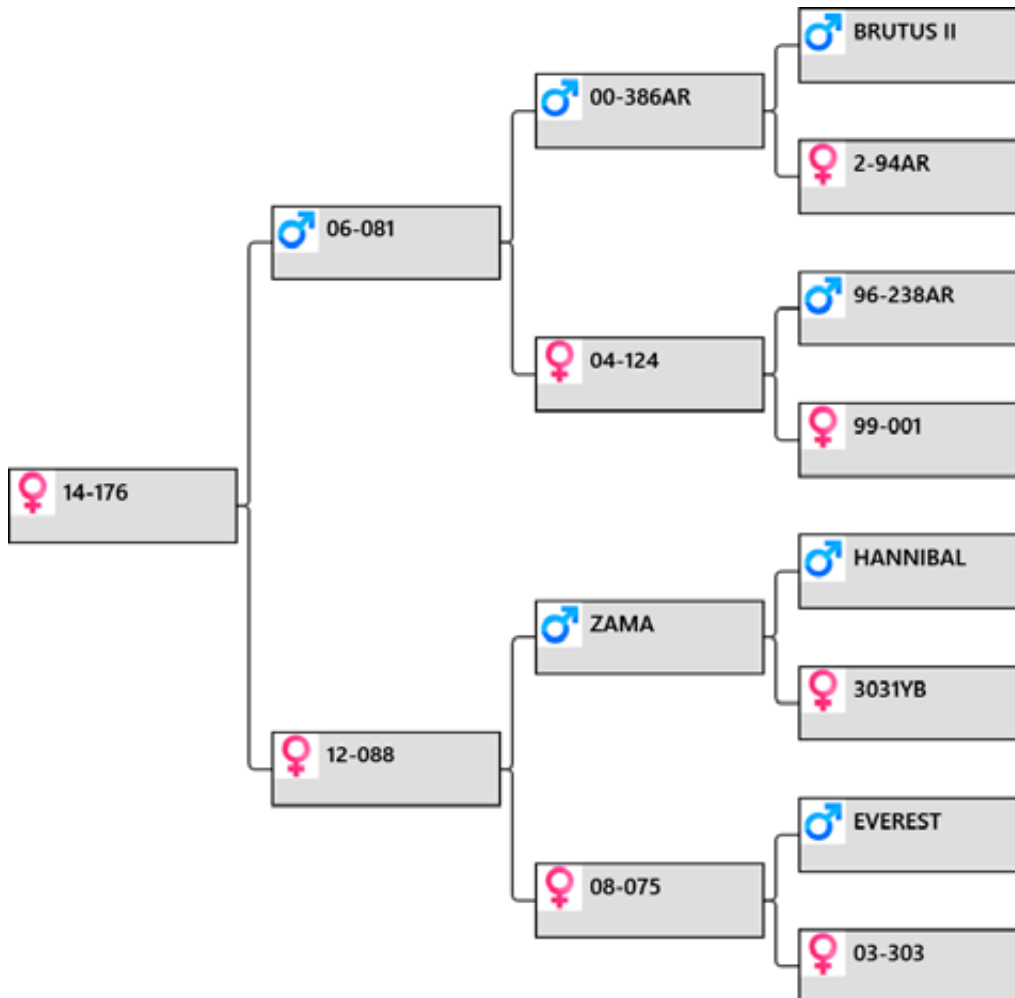

Biography:

88-12 and 75-08 have only produced females so hard to rank but 303-03 has produced a 2yr old cutting 5.75kg.

Sale weight:

Price:

Buyer:

lot # 68 – Yearling hind



Animal: **14-188**

Birthdate: 2014

<u>Weigh Date</u>	<u>Weight</u>
31/03/2015	69 kg
30/11/2015	91 kg

Pedigree:

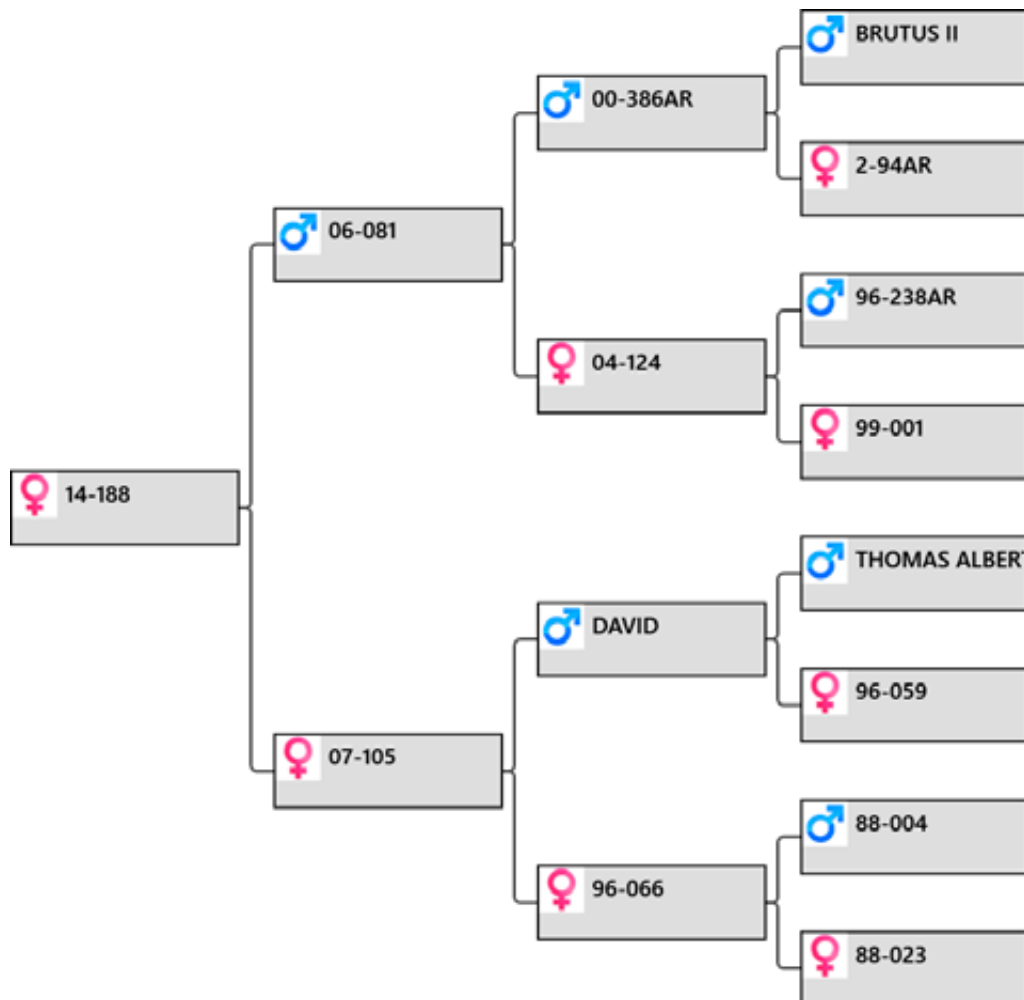

Biography:

105-07 has a son cutting 4.1kg at 2yr and 66-96 a son used in the stud plus a son sold 2012

Sale weight:

Price:

Buyer:



lot # 69 – Yearling hind



performance recorded since 1985

Yearling Hind sale 2016

Animal: **14-206**

Birthdate: 2014

Weigh Date	Weight
30/11/2015	104 kg

Pedigree:

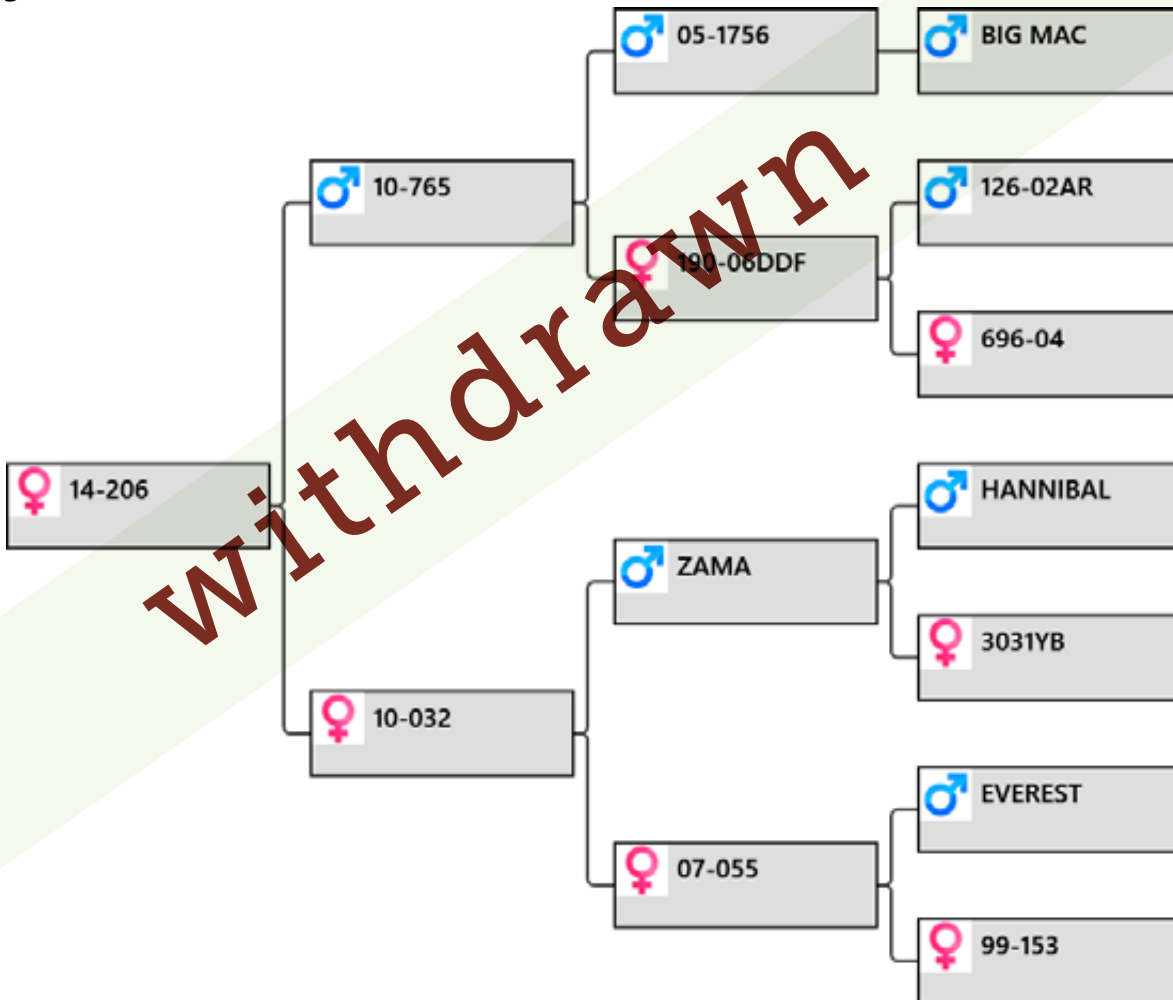

Biography:

765-10 plus Zama and Everest with 55-07 having a daughter sold 2013 for \$2800

Sale weight:

Price:

Buyer:

lot # 70 – Yearling hind



Animal: **14-207**

Birthdate: 2014

<u>Weigh Date</u>	<u>Weight</u>
31/03/2015	51 kg
30/11/2015	80 kg

Pedigree:

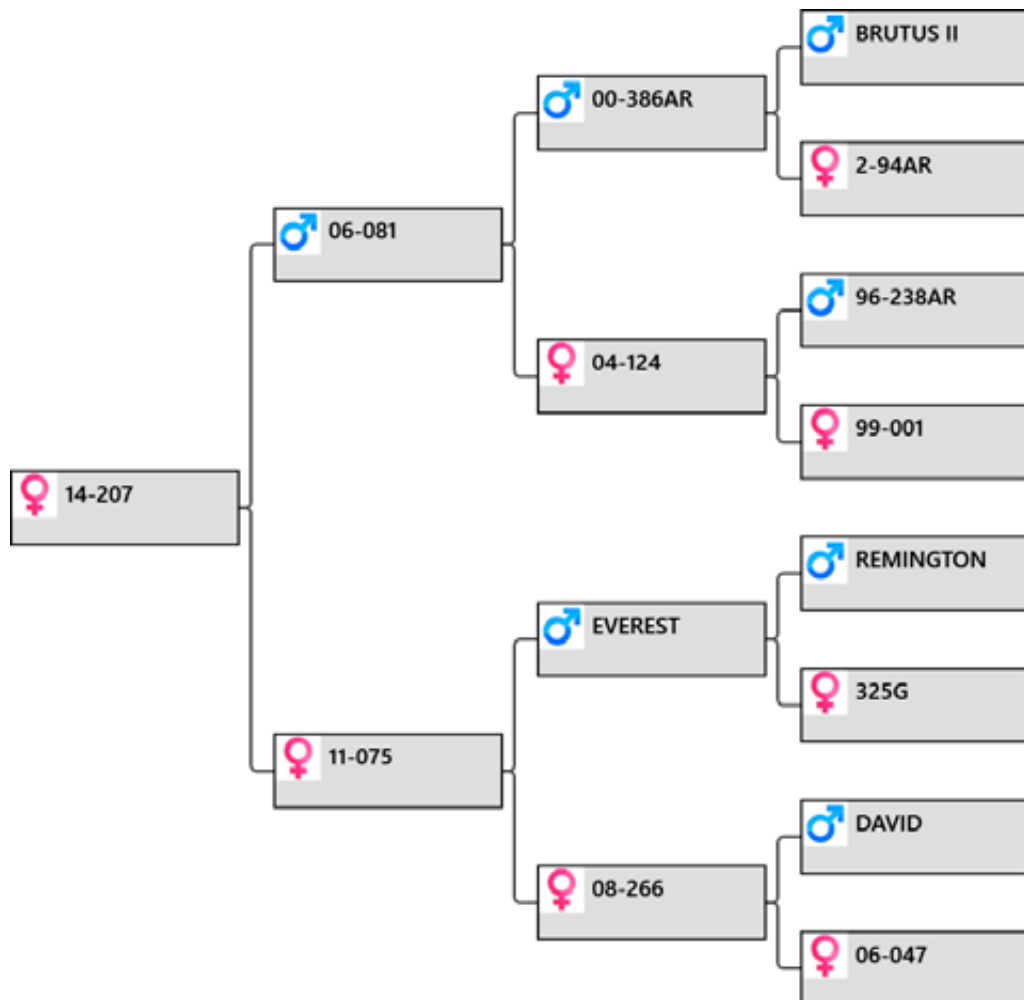

Biography:

81-06 plus Everest with 47-06 being dam of lot 5 122-12 6.95kg of very tidy velvet.

Sale weight:

Price:

Buyer:



lot # 71 – Yearling hind

Altrive Red Deer

performance recorded since 1985

Yearling Hind sale 2016

Animal: **14-208**

Birthdate: 2014

Weigh Date	Weight
31/03/2015	70 kg
30/11/2015	100 kg

Pedigree:

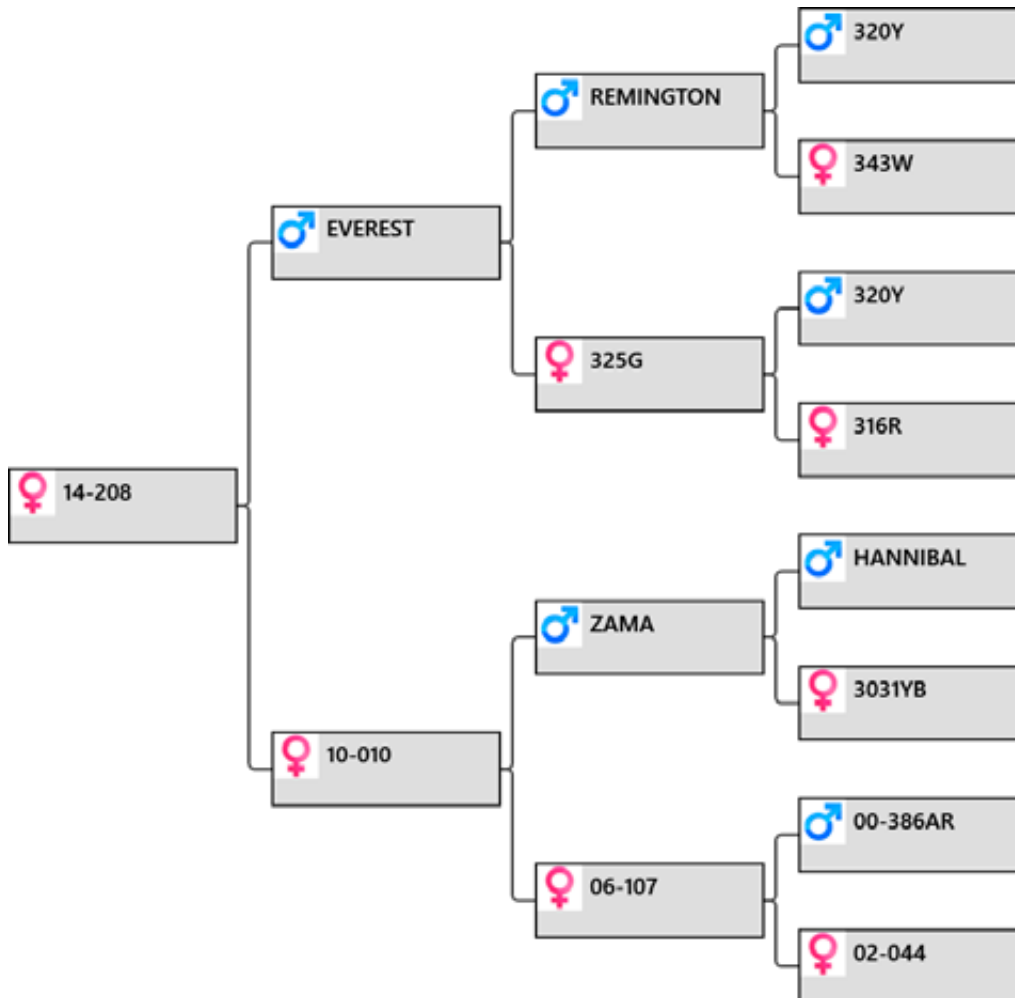

Biography:

Everest, Zama

Sale weight:

Price:

Buyer:

lot # 72 – Yearling hind



Animal: **14-214**

Birthdate: 2014

Weigh Date	Weight
31/03/2015	57 kg
30/11/2015	79 kg

Pedigree:

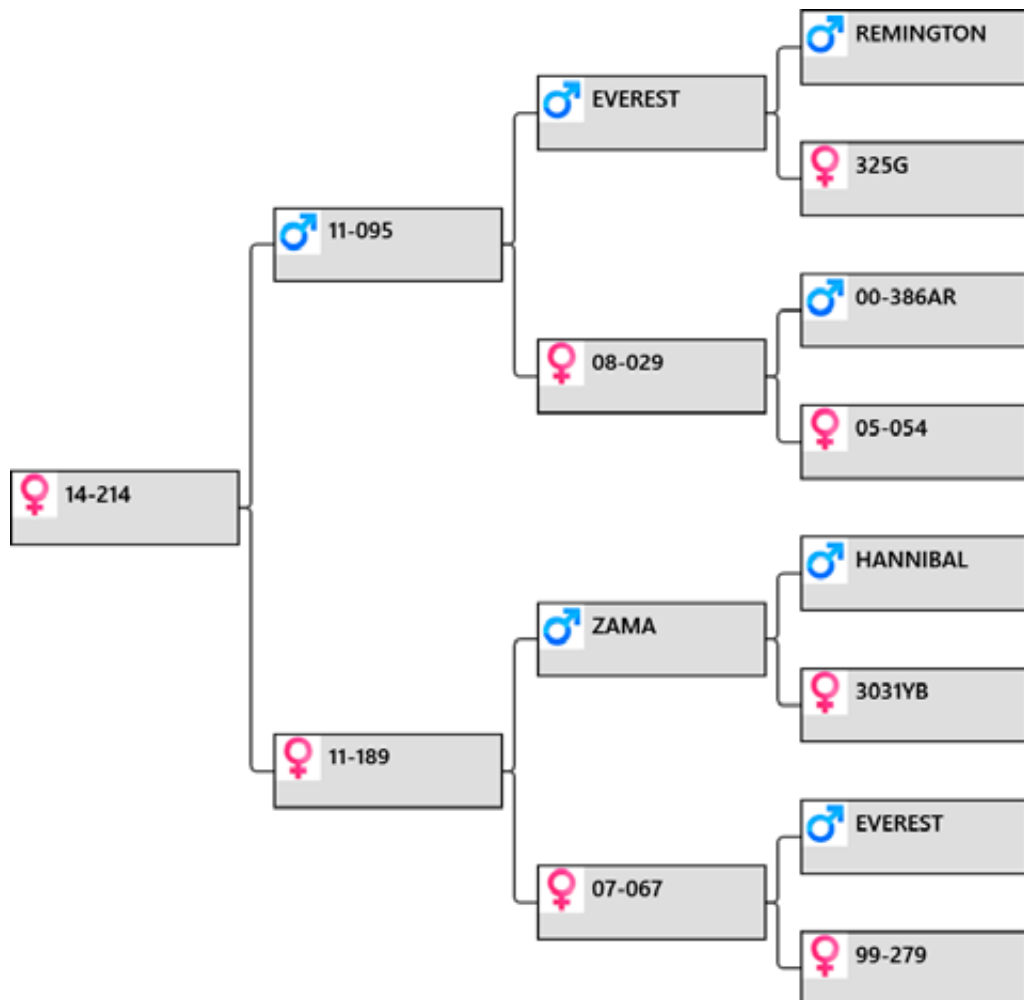

Biography:

95-11 plus Zama plus Everest with 67-06 producing a 4kg 2yr old

Sale weight:

Price:

Buyer:



lot # 73 – Yearling hind

Altrive Red Deer
performance recorded since 1985
Yearling Hind sale 2016

Animal: **14-223**

Birthdate: 2014

Weigh Date	Weight
31/03/2015	67 kg
30/11/2015	93 kg

Pedigree:

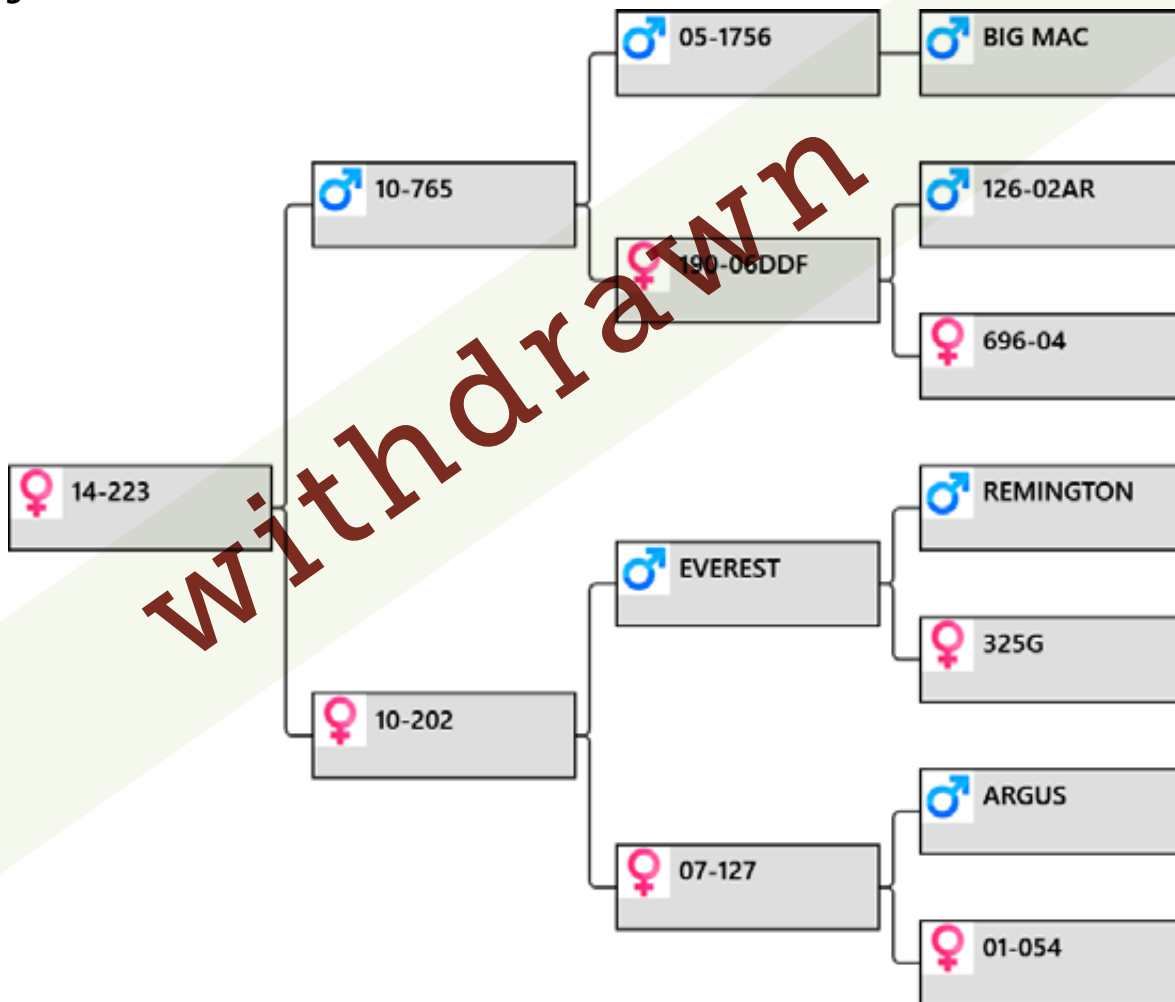

Biography:

765-10 7.8kg at 2yr plus Everest with 127-07 being dam of lot 3 last year plus 54-01 has 3 sons sold at auction.

Sale weight:

Price:

Buyer:

lot # 74 – Yearling hind



Animal: **14-228**

Birthdate: 2014

<u>Weigh Date</u>	<u>Weight</u>
31/03/2015	48 kg
30/11/2015	84 kg

Pedigree:

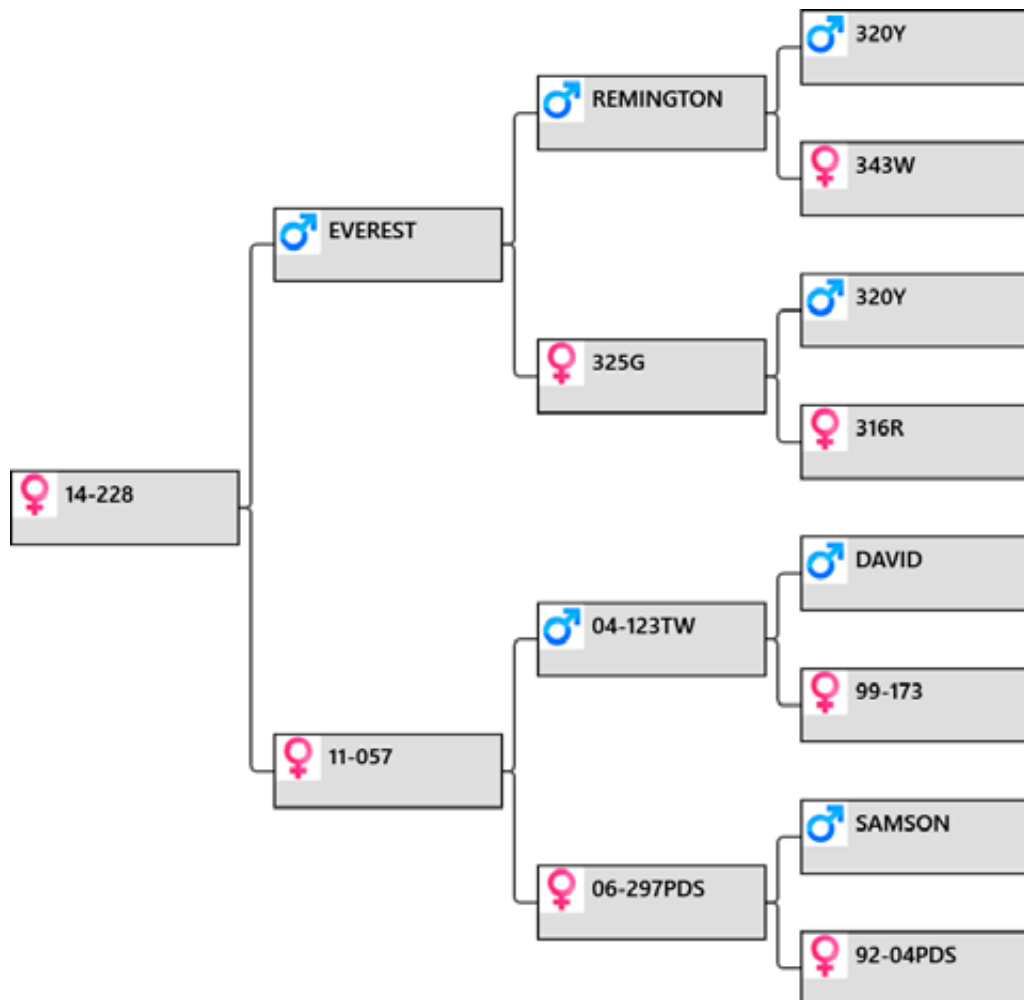

Biography:

Everest over 123-04 502 IOA at 4yr plus Samson former world champion.

Sale weight:

Price:

Buyer:



lot # 75 – Yearling hind

Altrive Red Deer

performance recorded since 1985

Yearling Hind sale 2016

Animal: **14-229**

Birthdate: 2014

Weigh Date	Weight
31/03/2015	71 kg
30/11/2015	102 kg

Pedigree:

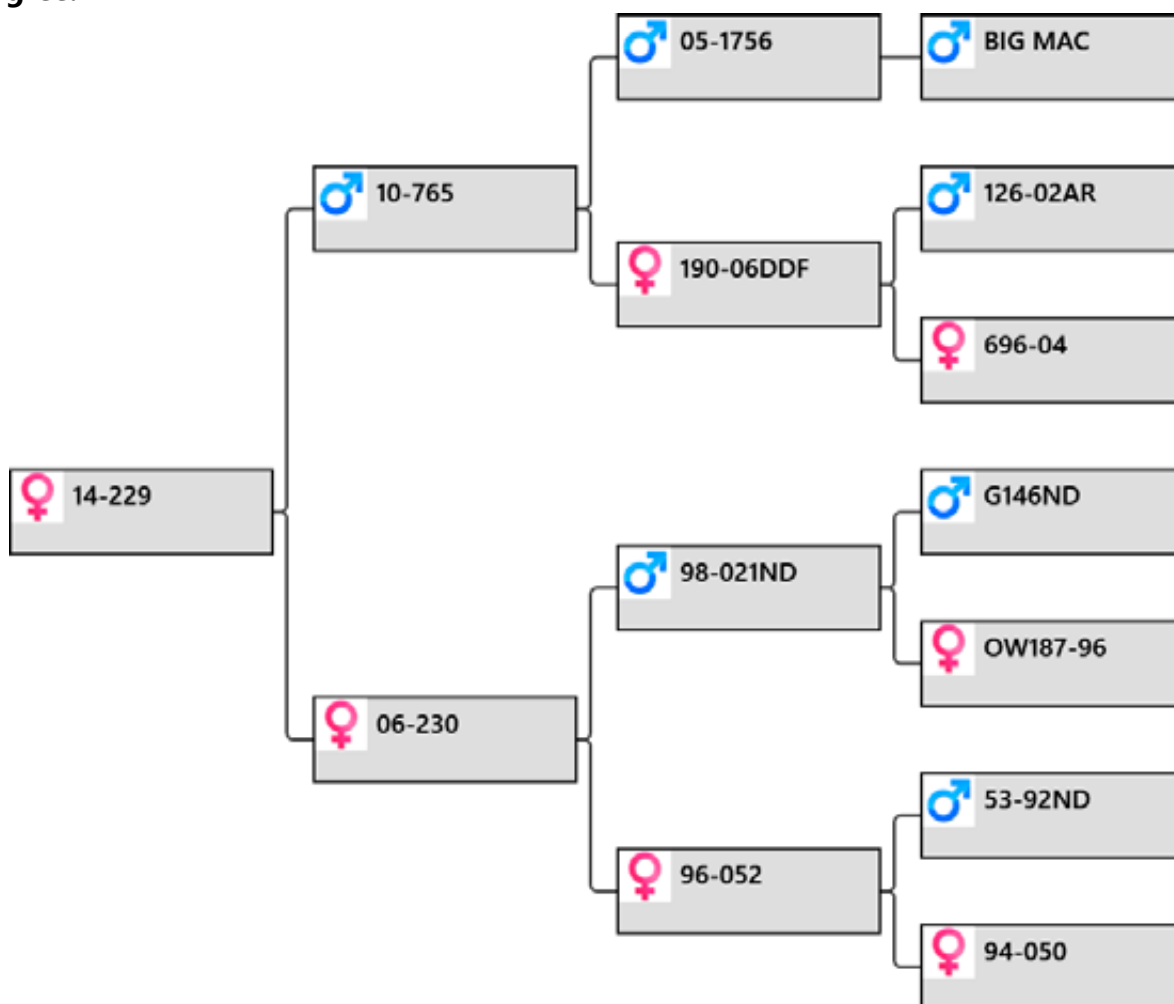

Biography:

230-06 has a 2yr old son cutting 4kg and 52-96 two 2 yr old sons cutting 4.35 and 4.25kg

Sale weight:

Price:

Buyer:

lot # 76 – Yearling hind



Animal: **14-232**

Birthdate: 2014

Weigh Date	Weight
31/03/2015	58 kg
30/11/2015	87 kg

Pedigree:

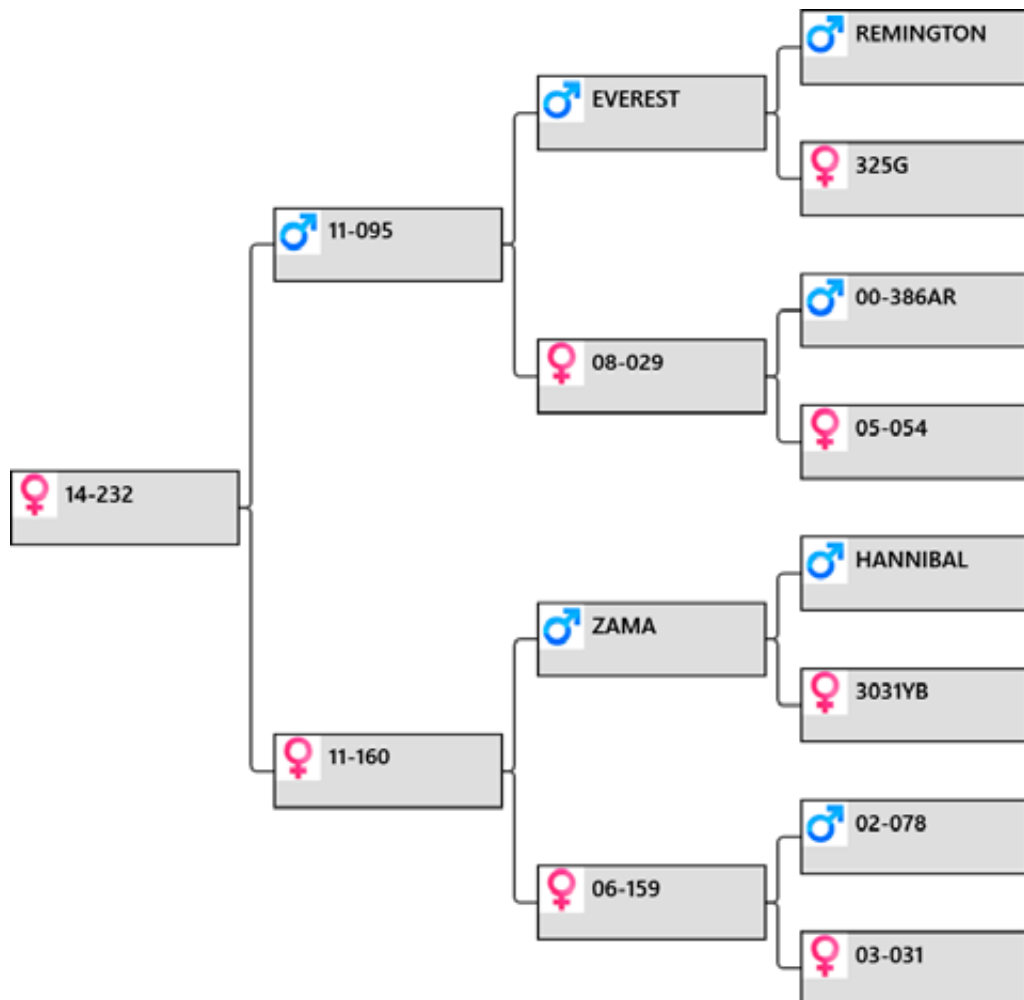

Biography:

160-11 and 159-06 have only produced females with 31-03 being dam of 110-08 8kg at 3yr

Sale weight:

Price:

Buyer:



lot # 77 – Yearling hind



performance recorded since 1985

Yearling Hind sale 2016

Animal: **14-238**

Birthdate: 2014

Weigh Date	Weight
31/03/2015	58 kg
30/11/2015	92 kg

Pedigree:

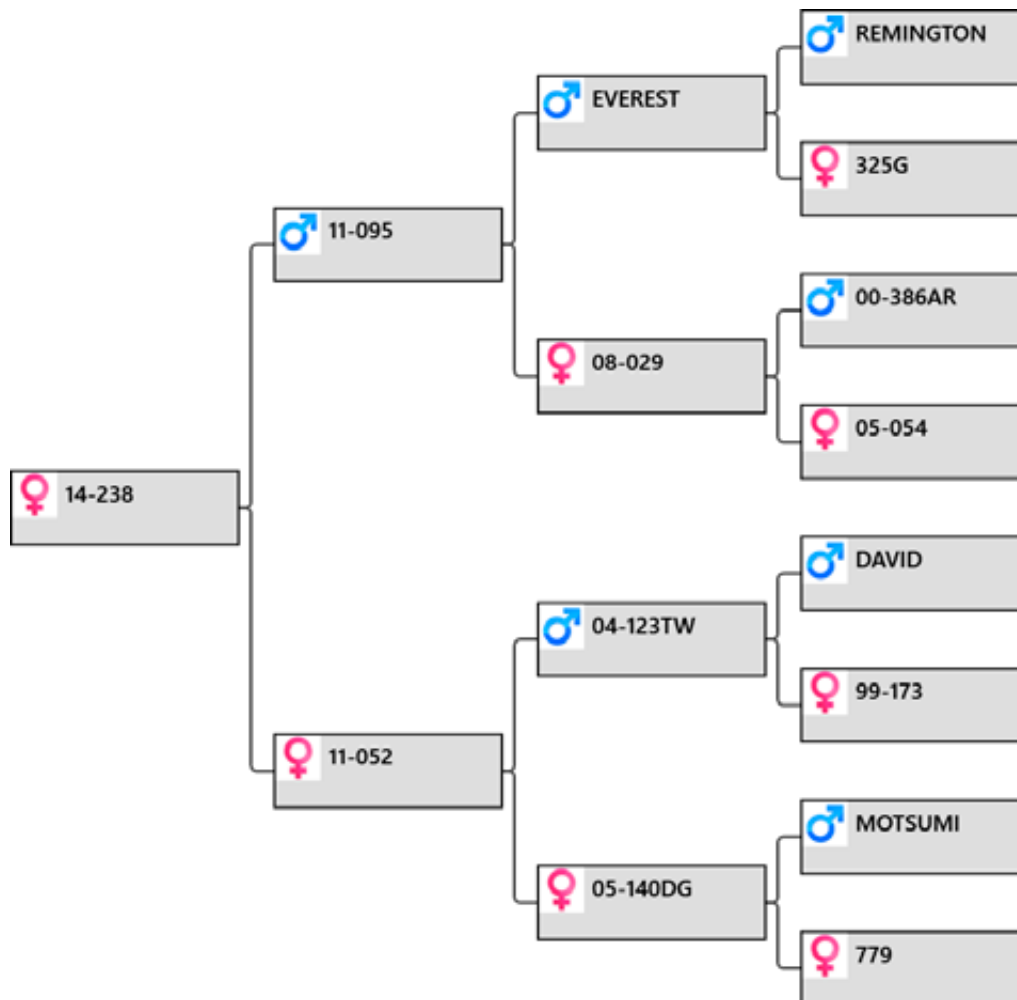

Biography:

No biography has been entered for this animal.

Sale weight:

Price:

Buyer:

lot # 78 – Yearling hind



Animal: **14-242**

Birthdate: 2014

<u>Weigh Date</u>	<u>Weight</u>
31/03/2015	59 kg
30/11/2015	87 kg

Pedigree:

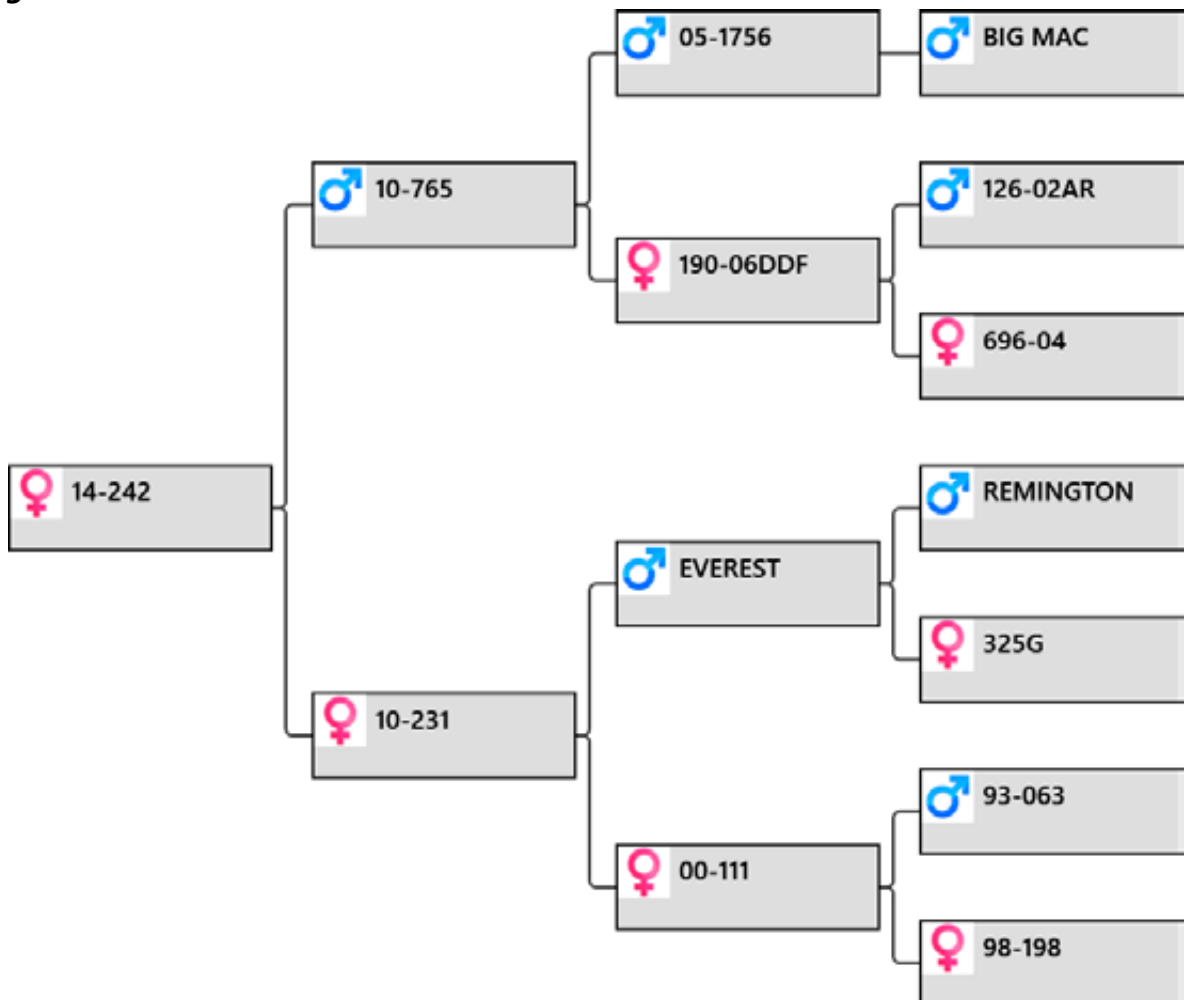

Biography:

231-10 has had 3 females. 111-00 two trophy sons. 198-98 a 2yr son cutting 4.15kg

Sale weight:

Price:

Buyer:



lot # 79 – Yearling hind



performance recorded since 1985
Yearling Hind sale 2016

Animal: **14-243**

Birthdate: 2014

Weigh Date	Weight
31/03/2015	52 kg
30/11/2015	79 kg

Pedigree:

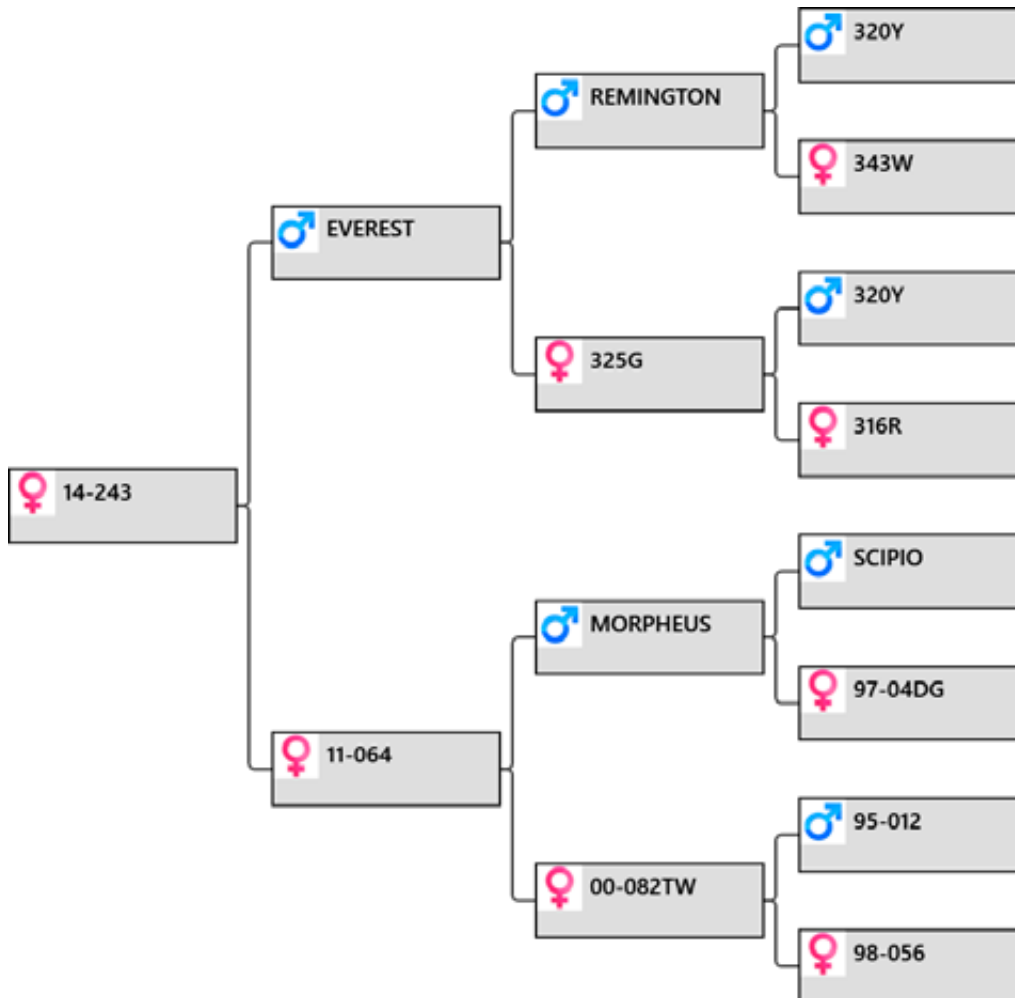

Biography:

Grand dam 82-00 sons sold for \$15000 and \$4000

Sale weight:

Price:

Buyer:

lot # 80 – Yearling hind

Animal: **14-244**

Birthdate: 2014

Weigh Date	Weight
31/03/2015	49 kg
30/11/2015	74 kg

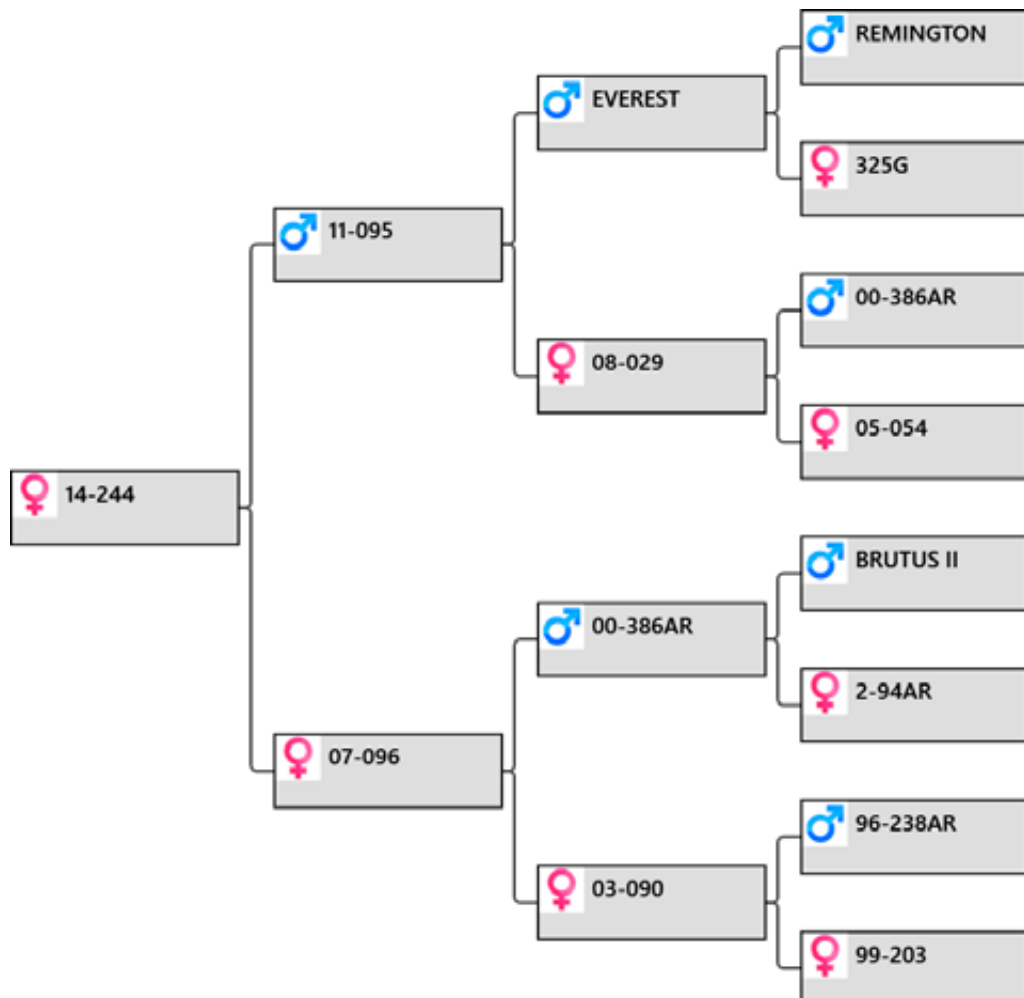
Pedigree:**Biography:**

sired by 95-11 third place national 2yr competition

Sale weight:

Price:

Buyer:



lot # 81 – Yearling hind



performance recorded since 1985

Yearling Hind sale 2016

Animal: **14-248**

Birthdate: 2014

Weigh Date	Weight
31/03/2015	48 kg
30/11/2015	78 kg

Pedigree:

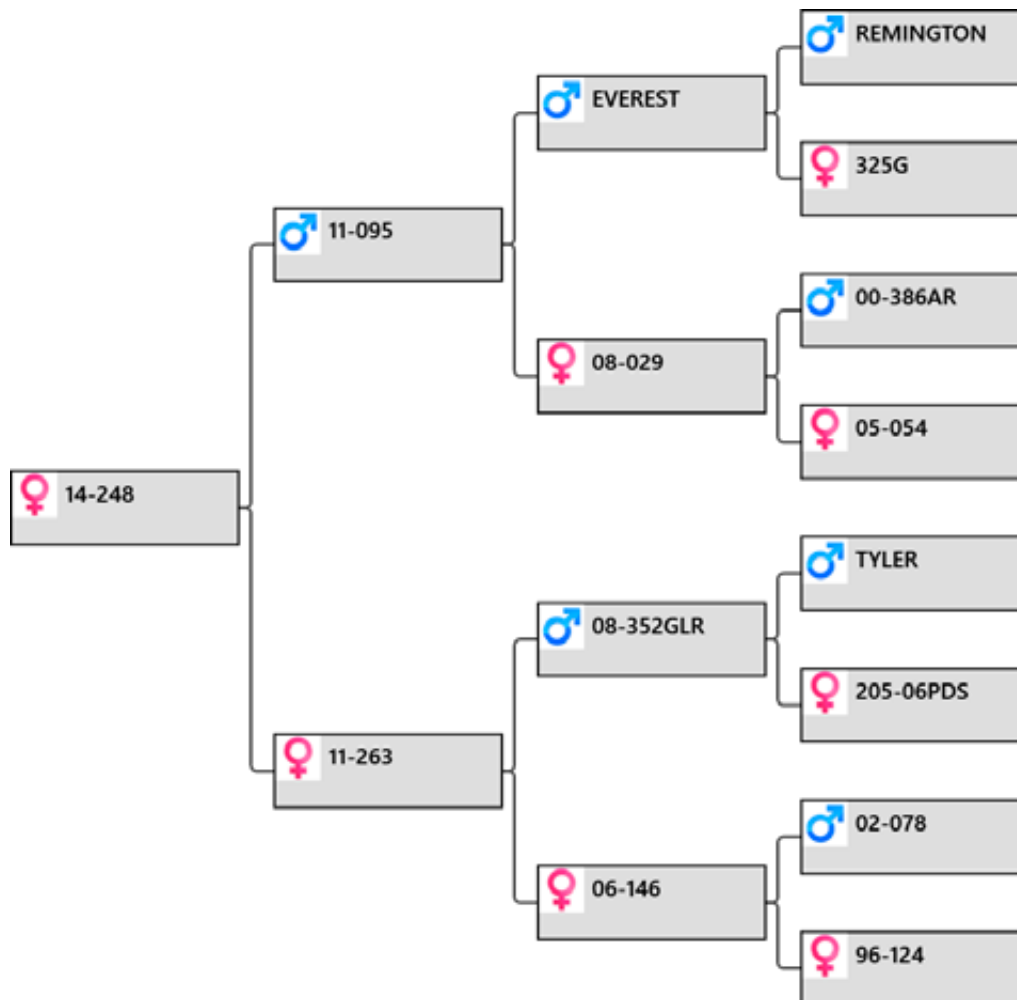

Biography:

95-11 over daughter of GLR 352-08 sire of 258-11 lot 5 2015 \$20,000

Sale weight:

Price:

Buyer:

lot # 82 – Yearling hind



Animal: **14-251**

Birthdate: 2014

Weigh Date	Weight
31/03/2015	51 kg
30/11/2015	77 kg

Pedigree:

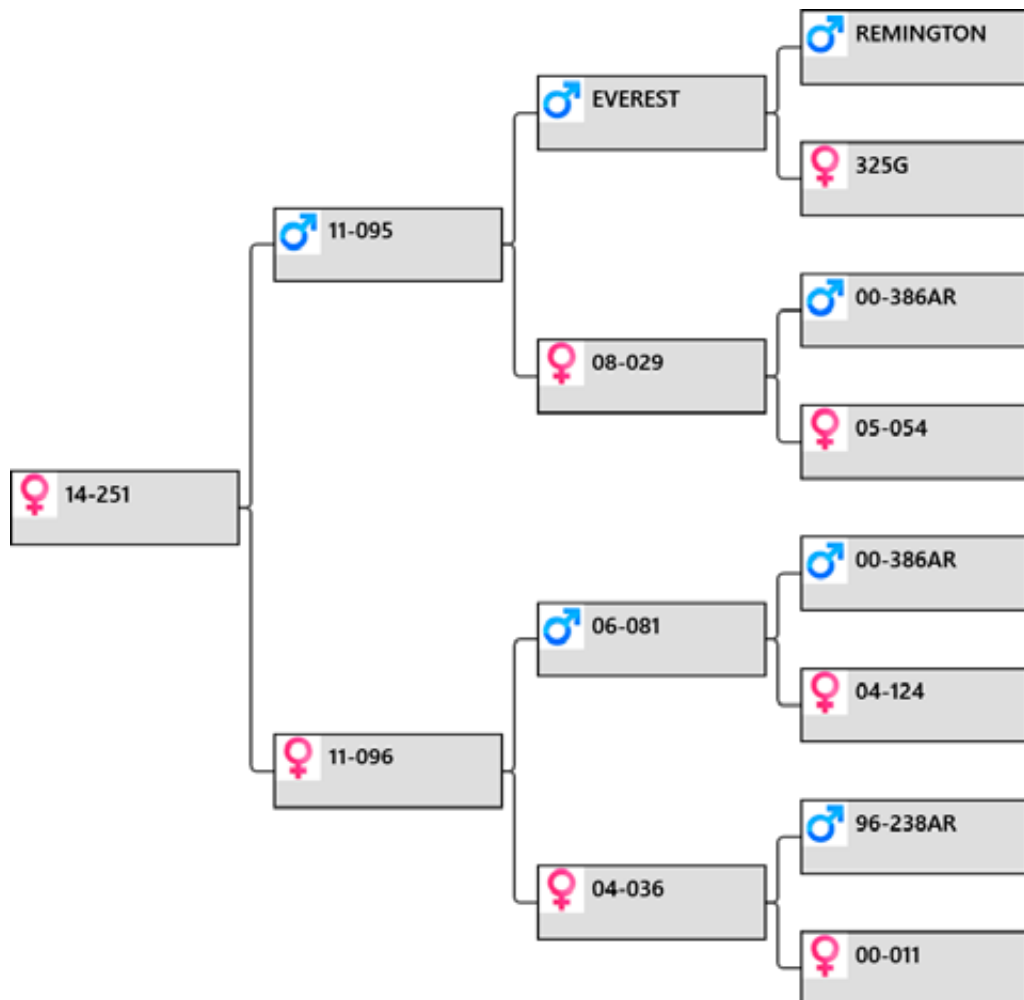

Biography:

No biography has been entered for this animal.

Sale weight:

Price:

Buyer:



lot # 83 – Yearling hind



performance recorded since 1985

Yearling Hind sale 2016

Animal: **14-261**

Birthdate: 2014

Weigh Date	Weight
31/03/2015	52 kg
30/11/2015	84 kg

Pedigree:

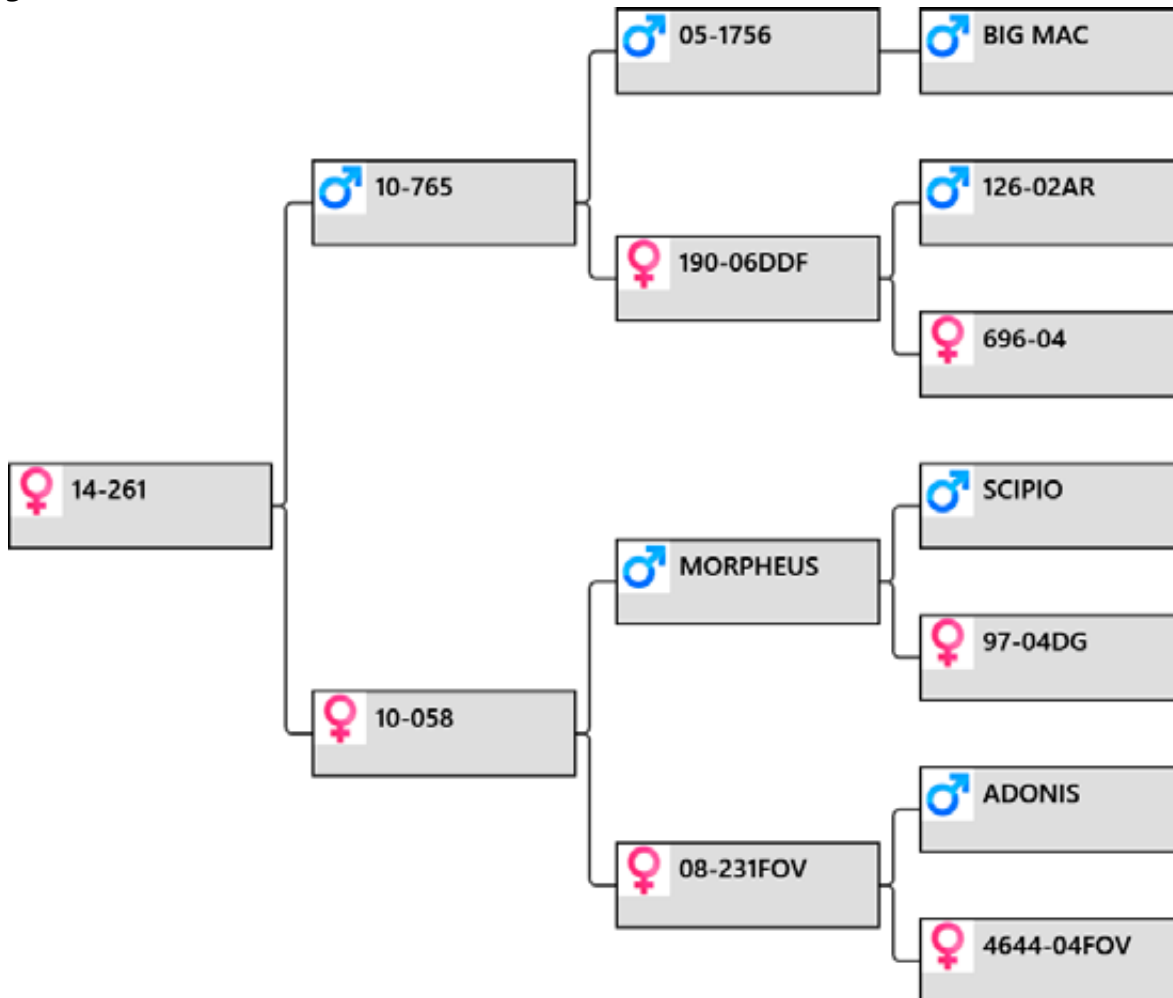

Biography:

Heavy velvet genetics plus top trophy genetics in bottom line

Sale weight:

Price:

Buyer:

lot # 84 – Yearling hind



Animal: **14-274**

Birthdate: 2014

<u>Weigh Date</u>	<u>Weight</u>
31/03/2015	49 kg
30/11/2015	78 kg

Pedigree:

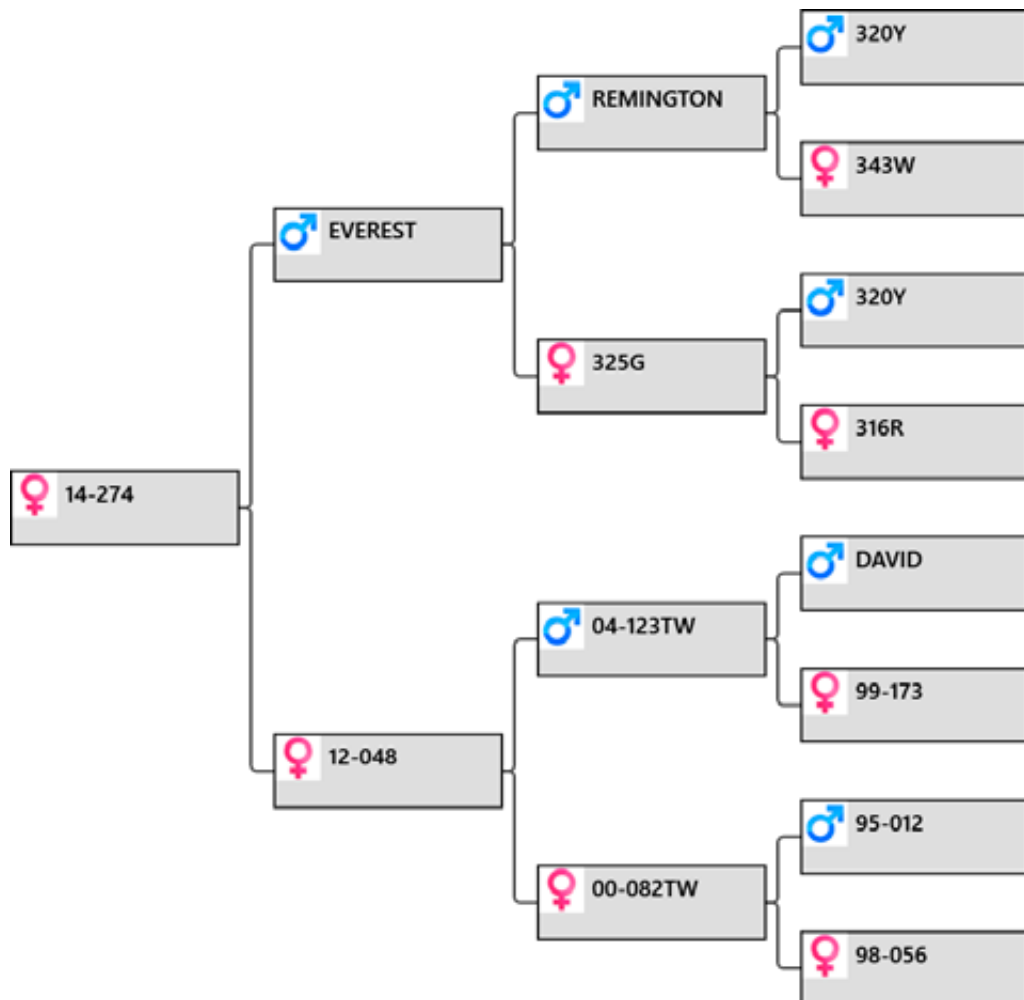

Biography:

Everest down to 82-00 dam of sons sold for \$15,000 and \$4000

Sale weight:

Price:

Buyer:



lot # 85 – Yearling hind



performance recorded since 1985

Yearling Hind sale 2016

Animal: **14-279**

Birthdate: 2014

Weigh Date	Weight
31/03/2015	50 kg
30/11/2015	76 kg

Pedigree:

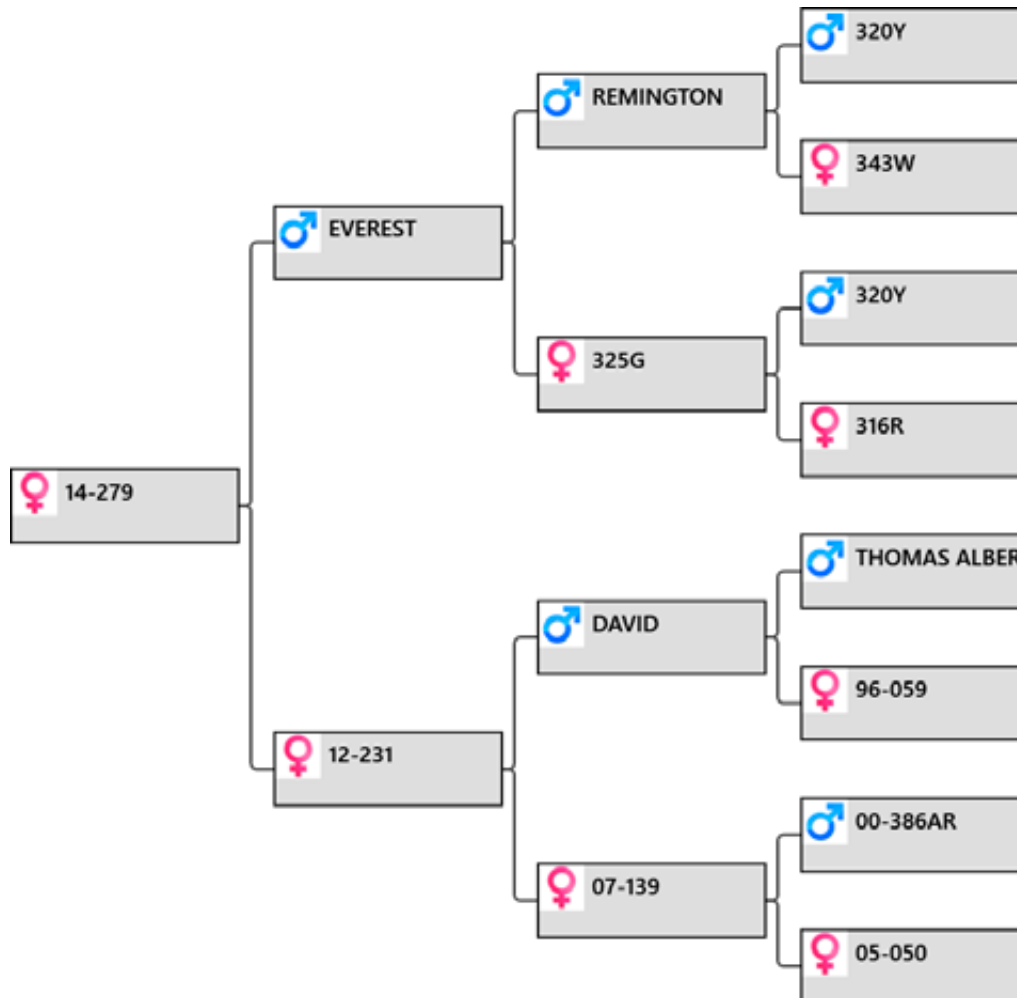

Biography:

Everest back to 139-07 with a son cutting 4.25kg at 2yr

Sale weight:

Price:

Buyer:

lot # 86 – Yearling hind



Animal: **14-281**

Birthdate: 2014

Weigh Date	Weight
31/03/2015	59 kg
30/11/2015	92 kg

Pedigree:

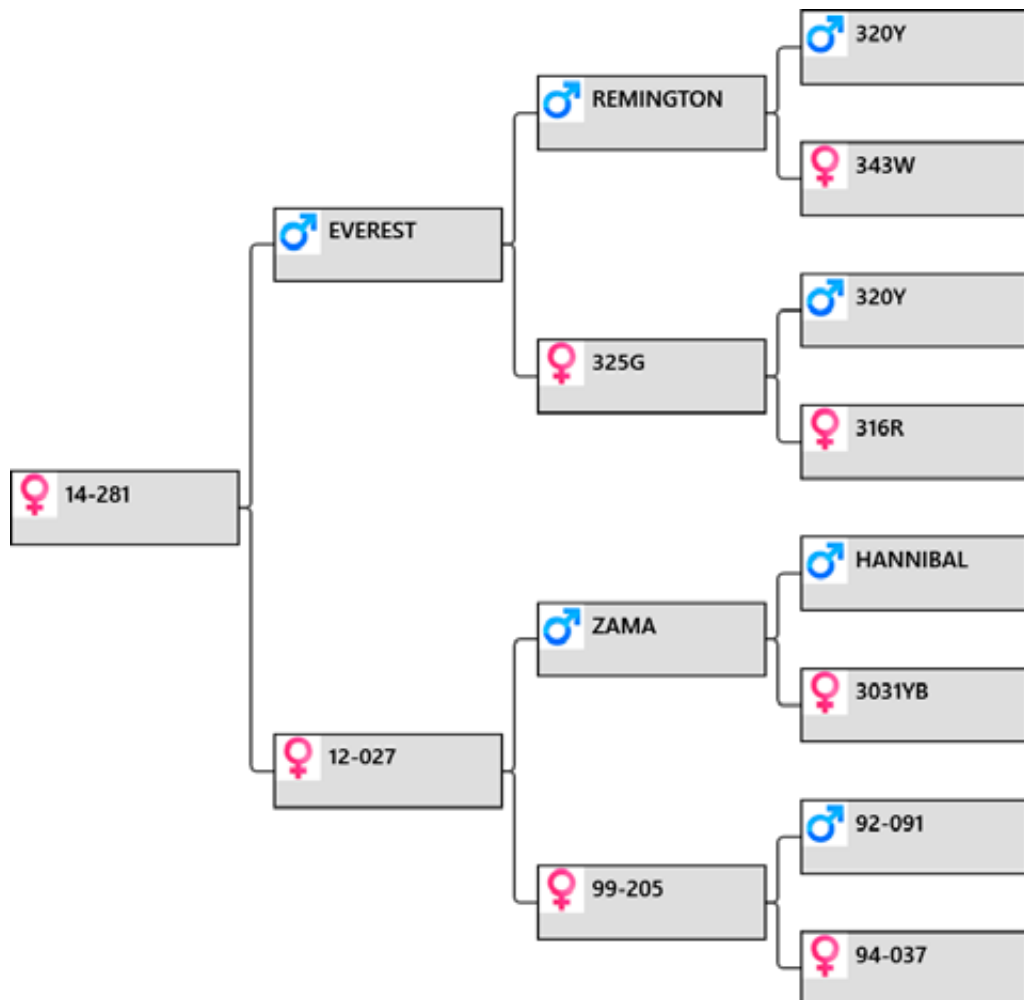

Biography:

Everest sire of 3 champions over Zama twice national champion

Sale weight:

Price:

Buyer:



lot # 87 – Yearling hind



performance recorded since 1985
Yearling Hind sale 2016

Animal: **14-282**

Birthdate: 2014

Weigh Date	Weight
31/03/2015	48 kg
30/11/2015	85 kg

Pedigree:

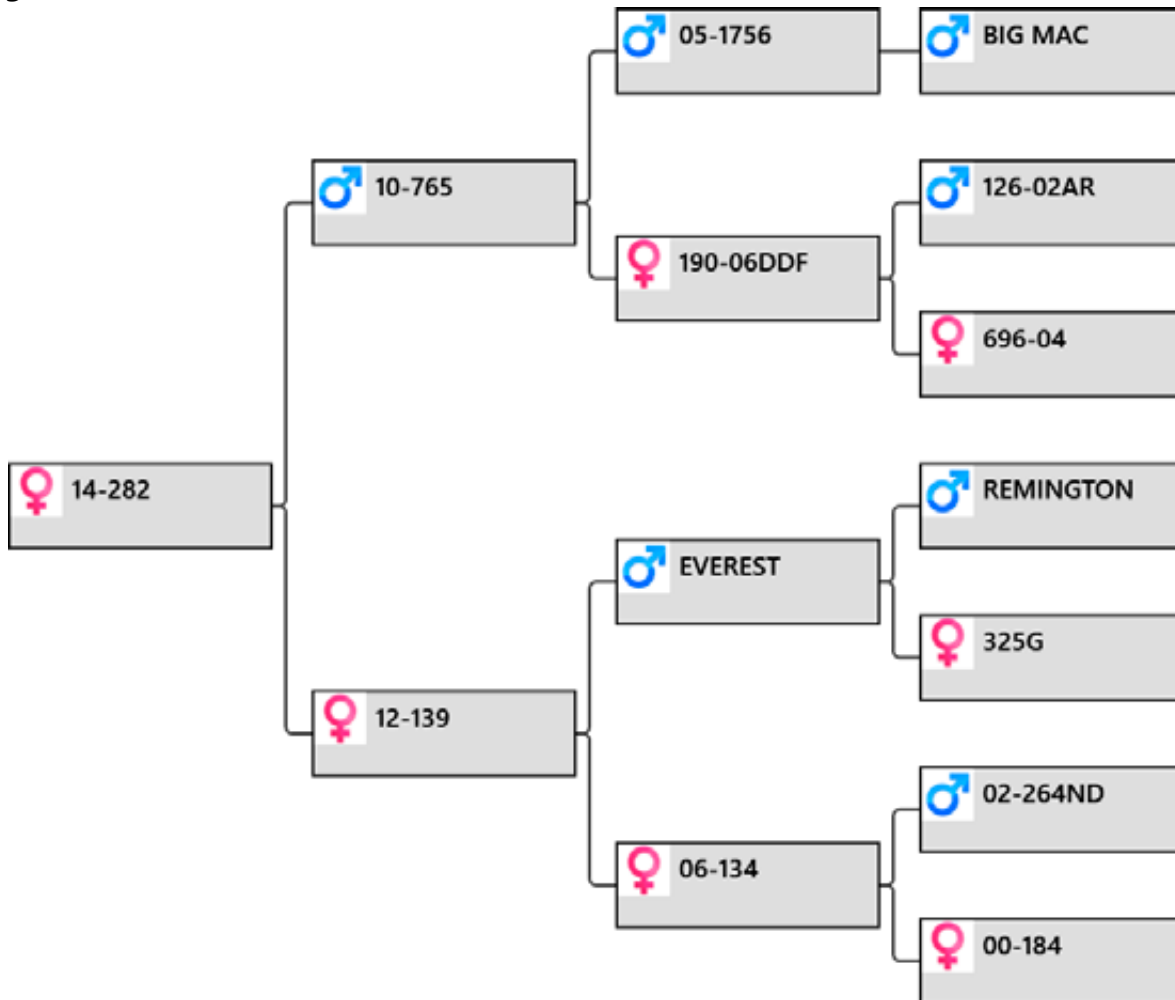

Biography:

765-10 7.8kg 2yr old over Everest down to 184-00 dam of sons sold for \$9,500 2013 and \$6,500 2014

Sale weight:

Price:

Buyer:

lot # 88 – Yearling hind



Animal: **14-291**

Birthdate: 2014

<u>Weigh Date</u>	<u>Weight</u>
31/03/2015	62 kg
30/11/2015	98 kg

Pedigree:

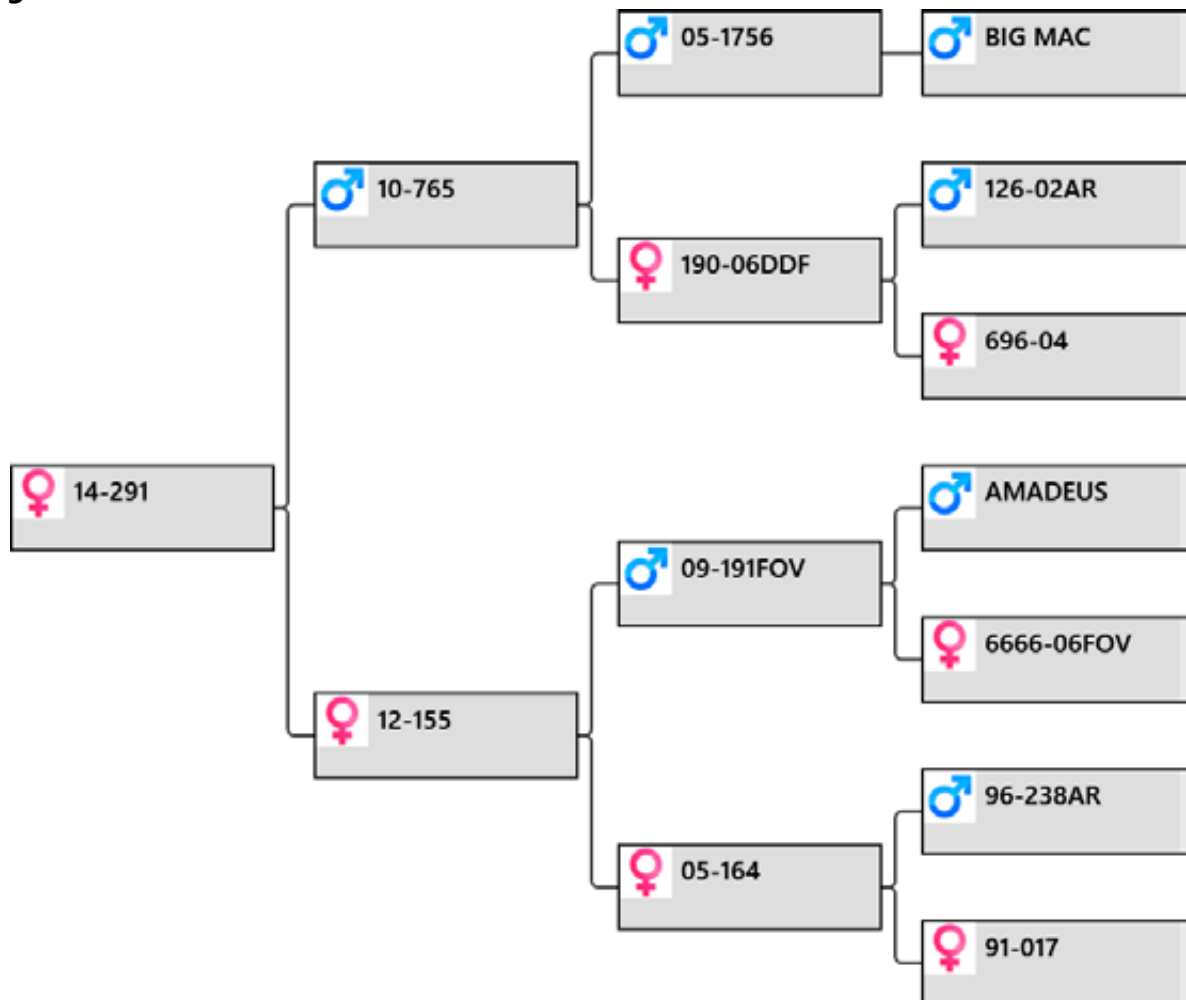

Biography:

765-10 7.8kg 2yr over daughter of Fov 191-09 sire of lot 6 216-12 7.4kg

Sale weight:

Price:

Buyer:



lot # 89 – Yearling hind



performance recorded since 1985

Yearling Hind sale 2016

Animal: **14-292**

Birthdate: 2014

Weigh Date	Weight
31/03/2015	58 kg
30/11/2015	96 kg

Pedigree:

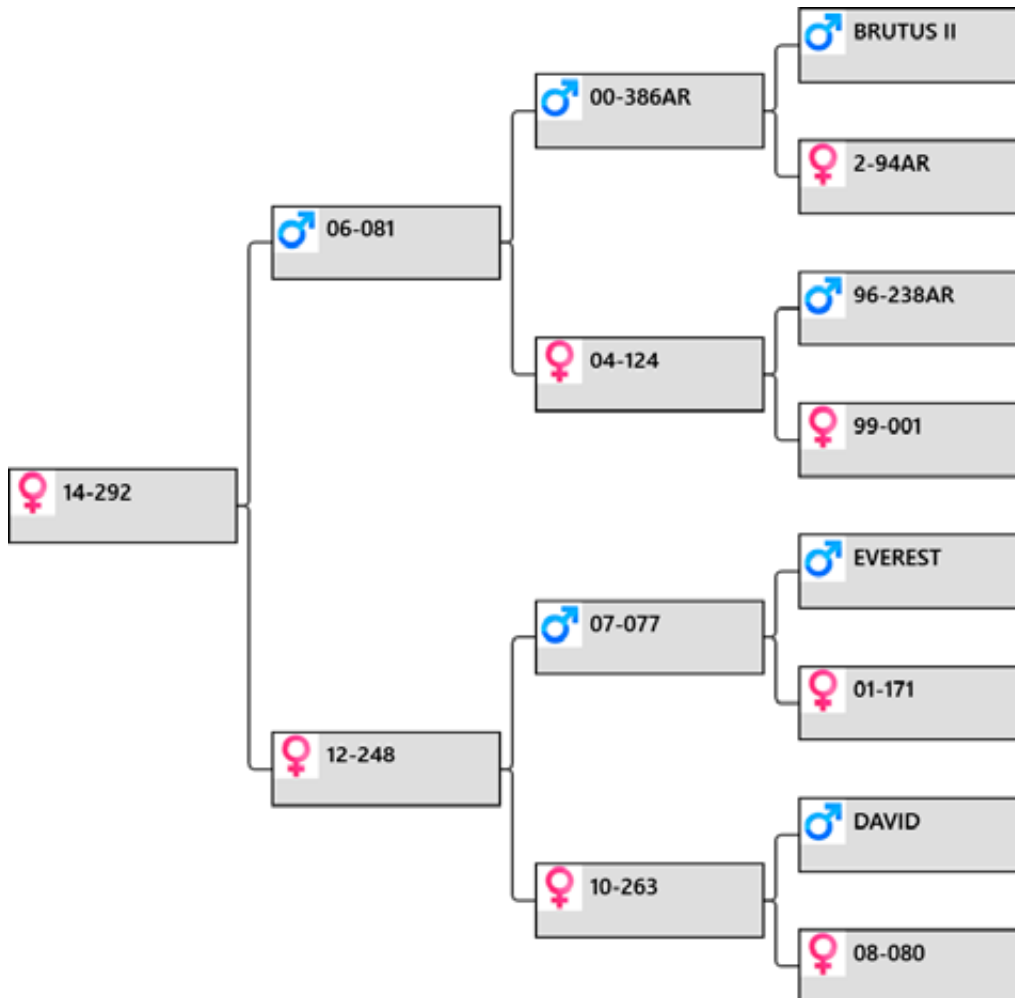

Biography:

National champion 81-06 over 77-07(10kg 6yr) daughter down to top hind 80-08 dam of lot 1 2015 171-11 sold for \$25,000

Sale weight:

Price:

Buyer:

lot # 90 – Yearling hind



Animal: **14-293**

Birthdate: 2014

<u>Weigh Date</u>	<u>Weight</u>
31/03/2015	58 kg
30/11/2015	83 kg

Pedigree:

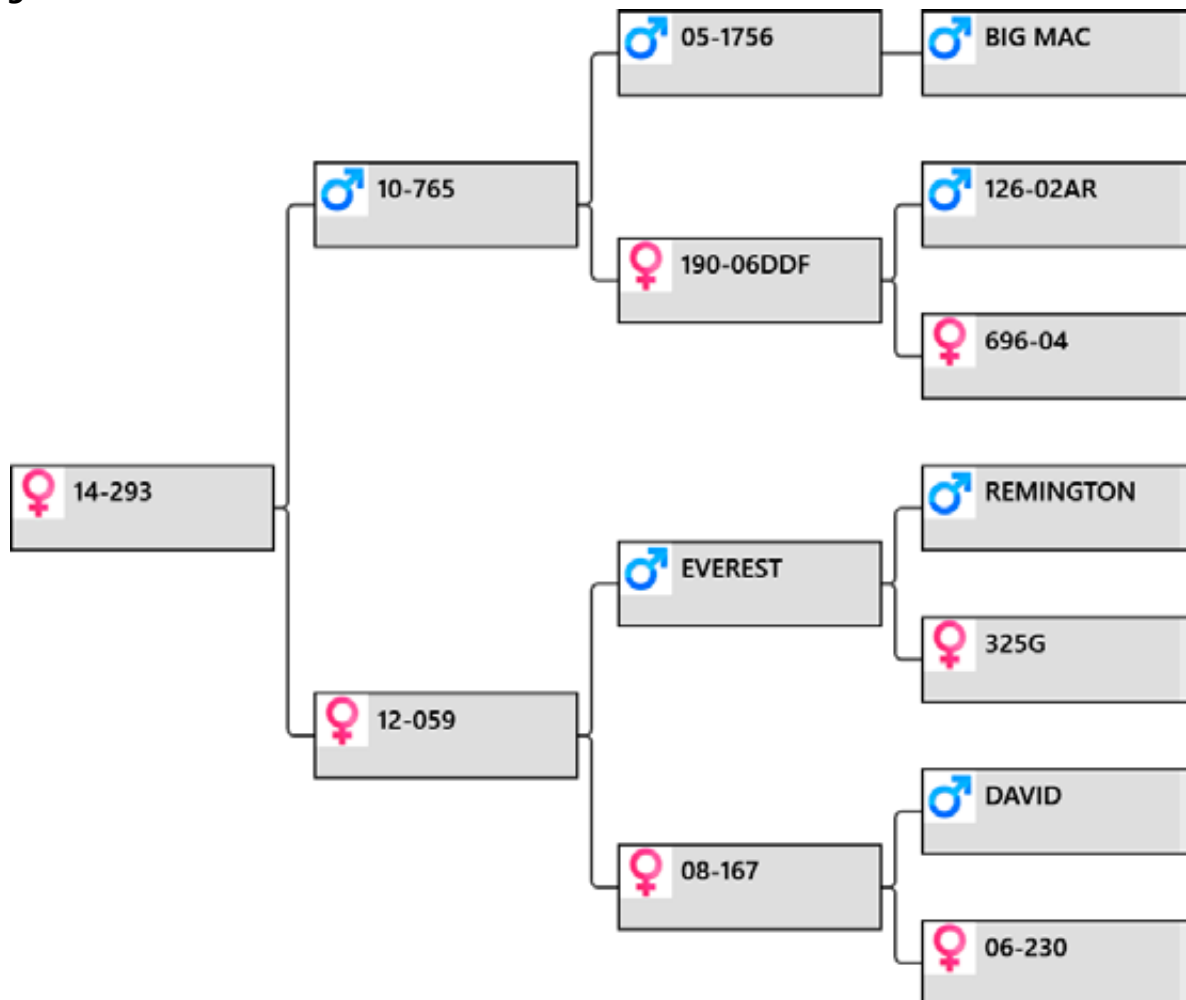

Biography:

167-08 2 daughters 230-06 a 2yr son cutting 4kg and 52-96 2sons cutting 4.35kg and 4.25kg at 2yr

Sale weight:

Price:

Buyer:



lot # 91 – Yearling hind Replacement hind



Altrive Red Deer
performance recorded since 1985
Yearling Hind sale 2016

Animal: **14-156**

Birthdate: 2014

Weigh Date	Weight
31/03/2015	51 kg
30/11/2015	94 kg

Pedigree:

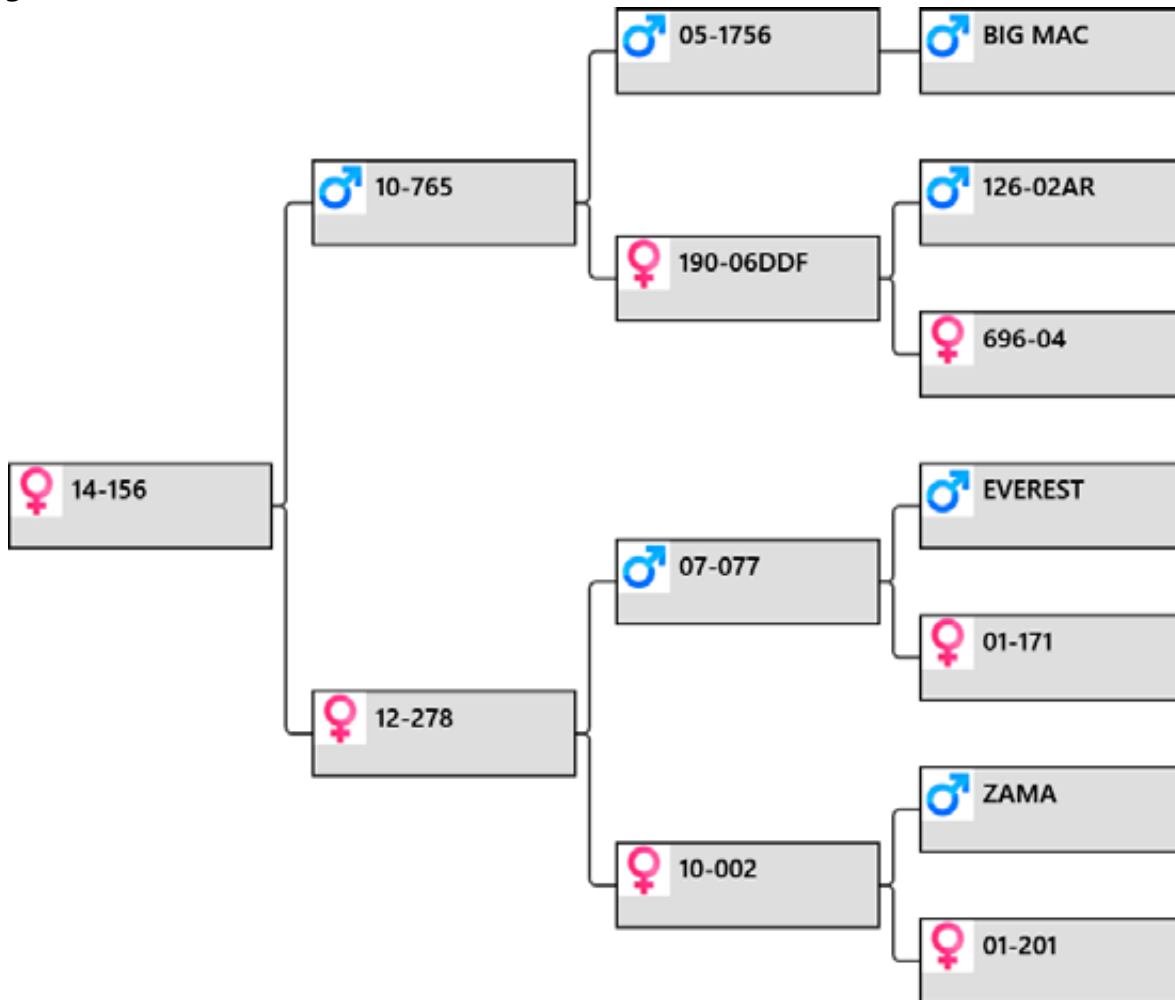

Biography:

765-10 7.8kg @ 2yr over 77-07 10kg @ 6yr, plus Zama and Everest.

Sale weight:

Price:

Buyer:

lot # 92 – Yearling hind Replacement hind



Animal: **14-192**

Birthdate: 2014

Weigh Date	Weight
31/03/2015	60 kg
30/11/2015	83 kg

Pedigree:

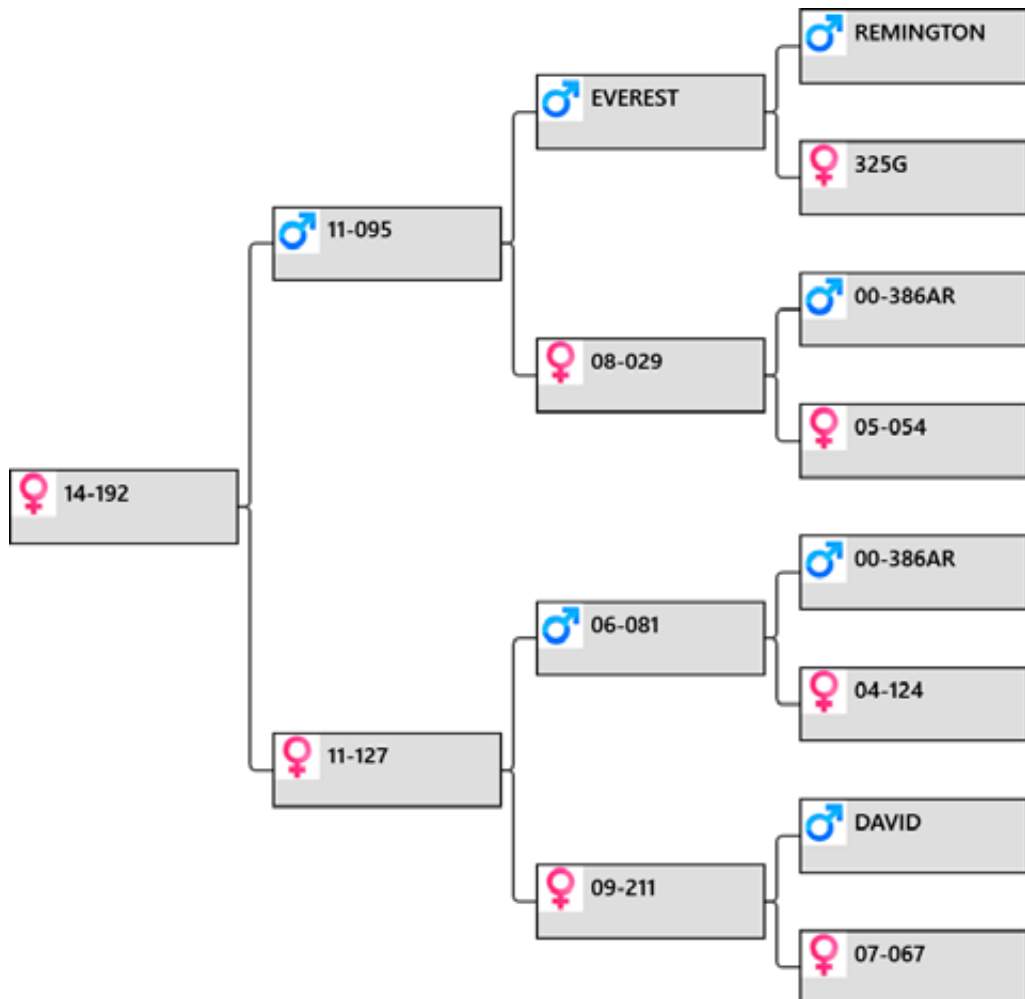

Biography:

95-11 7kg @ just 2yr old plus Everest and 81-06.
 211-09 2yr son @ 4.3kg
 67-07 2yr son @ 4kg.

Sale weight:

Price:

Buyer:



lot # 93 – Yearling hind Replacement hind



Altrive Red Deer
performance recorded since 1985
Yearling Hind sale 2016

Animal: **14-200**

Birthdate: 2014

Weigh Date	Weight
31/03/2015	53 kg
30/11/2015	85 kg

Pedigree:

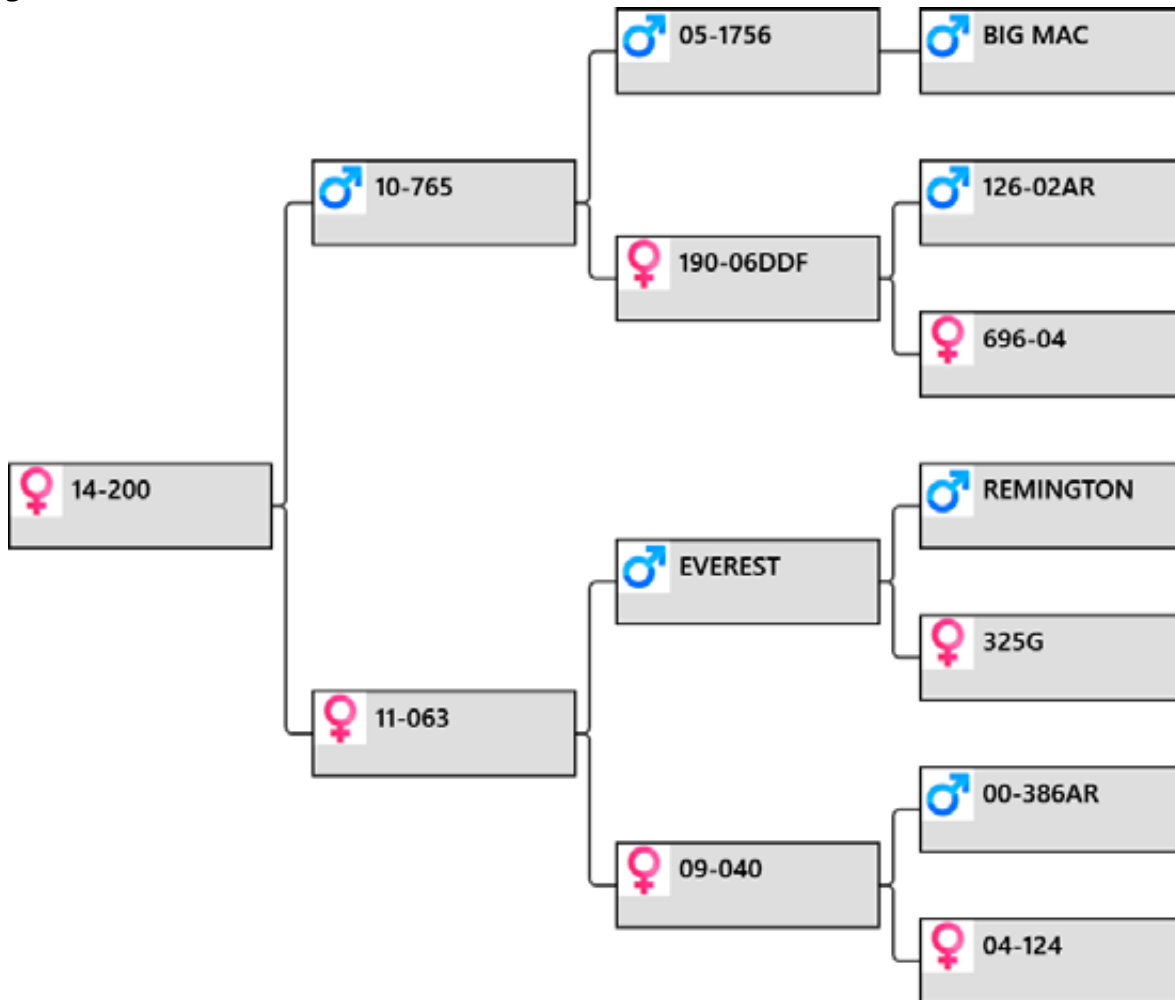

Biography:

765-10 7.8kg @ just 2yr old, then Everest over 40-09 a full sister to 81-06 national 4yr champion, then 17.2kg SS velvet @ 9YR

Sale weight:

Price:

Buyer:



more Zama progeny

Three 2yr old ET brothers by Zama out of a first fawner Everest daughter.



21-13
5.05kg @ 2yr



89-13 2yr old
*This stag was cut 2 days after this photograph – 8.3kg SA.
24cm and 21cm beam, and 27cm and 28cm above the trez*



38-13
6.45kg @ 2yr



Zama 74-06 – 11.3kg SA 6yr