

**Altrive  
Red Deer**

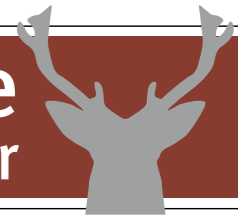

performance recorded since 1985

**Geoff and Lynette Elder**  
P 03 202 5809 M 0274 365214  
[www.altrivereddeer.co.nz](http://www.altrivereddeer.co.nz)

# 2015 Sales Catalogue

**4th on-farm DEER SALE**  
**Friday 9th January 2015 5.00pm**



Zama 74-06 - growing out Dec 2011



Open Champion  
Zama 74-06

Zama 74-06 - 11.3kg SA 6yr



## legal

### Conditions of Sale

1. The Sale will be conducted by PGG Wrightson with the conditions of sale as set down by the Stock and Stations Agents Association, a copy of which is exhibited in the office on sale day.
2. Each lot becomes the purchaser's property and risk at fall of the hammer.
3. Warranties and Insurance are covered under separate headings.
4. Terms are strictly cash unless prior arrangements are made with the auctioneers. Accounts not paid within 14 days of sale shall bear interest, at current rate per annum from the date of sale.
5. The sale is conducted exclusive of GST.
6. A buyers commission of 4% is payable to non-participating companies and recognised independent agents introducing and accompanying purchasers to the sale providing prior arrangements [No later than 24hrs prior to sale] are made with PGG Wrightson.
7. Intending purchasers are required to register with the auctioneers prior to the commencement of the sale.
8. No Animals, embryos or semen sold by Altrive, or their germplasm, any subsequent progeny or germplasm, including the semen and germplasm of that progeny may be supplied to a third party without the written permission of the stud.
9. This condition does not affect normal commercial deer farming or stud farming or the normal sales of semen or embryos as it only applies to entities with the primary function of commercial semen/germplasm activities.
10. It is a condition of sale of any animals, embryos, germplasm or semen sold by Altrive that the purchaser agrees to include the following clause as a condition of any subsequent sale of gift of any animal, embryo, semen,germplasm or subsequent progeny or germplasm to a third party-"the purchaser acknowledges that it will not supply any animals, embryos, semen or germplasm to any commercial semen/germplasm marketing or sales entity, and will ensure that this clause is inserted as a condition of any sale or gift of any animals, embryos, semen or germplasm."

### Disclaimer

All details and descriptions as to stock referred to in the catalogue have been supplied to PGG Wrightsons by the vendor and have not been independently verified by PGG Wrightson. PGG Wrightson, its employees and agents make no representations or warranties or acknowledgement of any kind whatsoever in relation to any part of this catalogue [including but not limited to accuracy or completeness of details and descriptions of stock {and other contents}]

Purchasers, advisers and all other persons viewing or dealing with the stock must make their own assessment on the stock and the information in this catalogue.

PGG Wrightson, it's employees and agents are not responsible or liable in any way whatsoever, weather in contract, tort [including negligence], or otherwise, to any person for any loss or any damage whatsoever arising directly or indirectly from any information or misrepresentation included or omitted from this catalogue.

Velvet will be on display on sale day and will remain the property of the vendor.

### Testing

Altrive is TB accredited C10 and all Sires and Yearling Hinds are tested Johnes negative.

Our whole herd is DNA tested.

## finding altrive

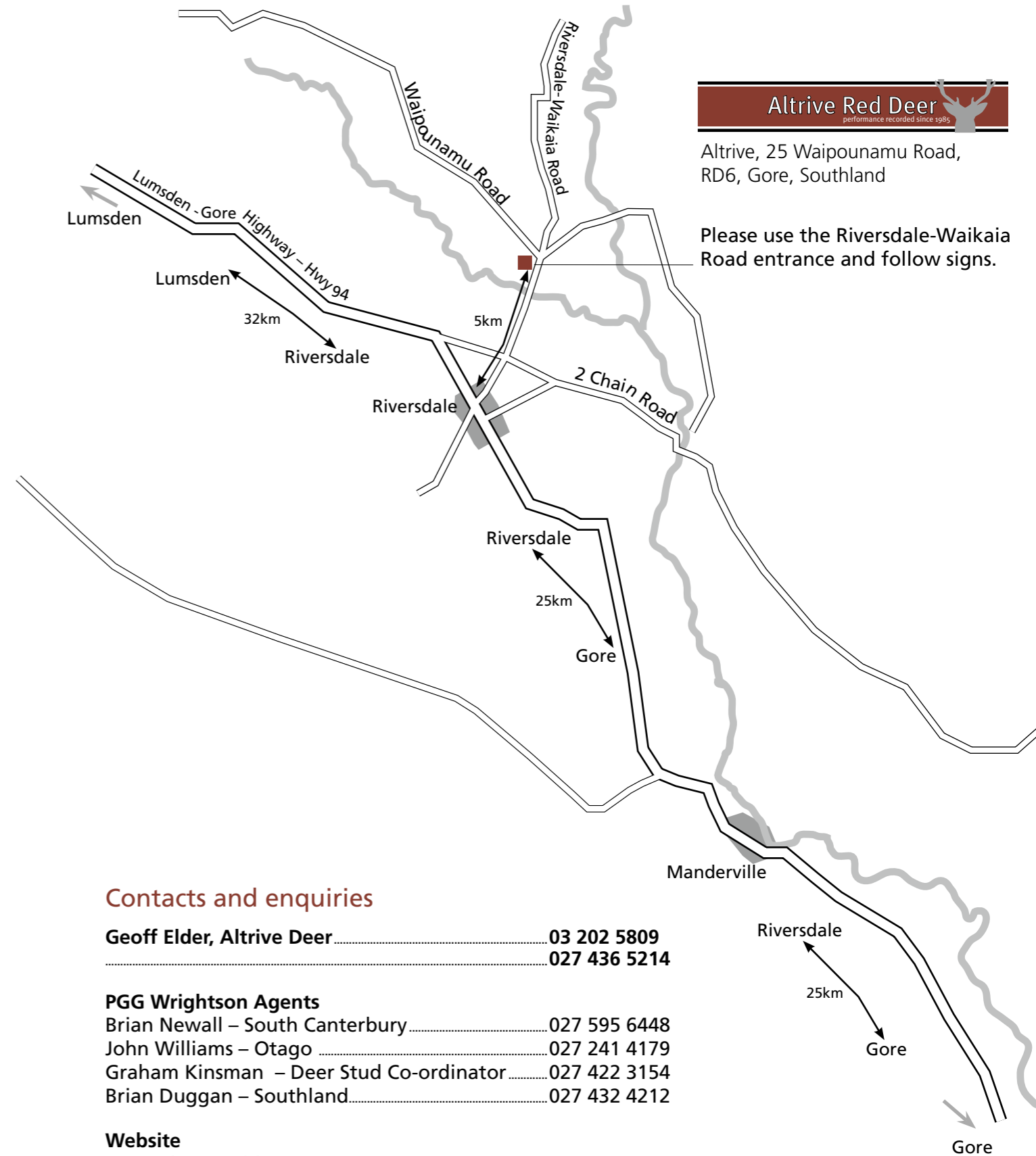

Altrive Red Deer  
performance recorded since 1985

Altrive, 25 Waipounamu Road,  
RD6, Gore, Southland

Please use the Riversdale-Waikaia  
Road entrance and follow signs.

### Contacts and enquiries

Geoff Elder, Altrive Deer ..... 03 202 5809  
..... 027 436 5214

#### PGG Wrightson Agents

Brian Newall – South Canterbury ..... 027 595 6448  
John Williams – Otago ..... 027 241 4179  
Graham Kinsman – Deer Stud Co-ordinator ..... 027 422 3154  
Brian Duggan – Southland ..... 027 432 4212

#### Website

www.altrivereddeer.co.nz



## sire stags at altrive Everest 341-04



9.84kg 5yr. 4th 5yr 2009



10.65kg sa 6yr.  
5th place National Open

### Progeny of Everest 341-04



53-07 6.2kg 2yr    77-07 8.24kg sa 4yr    76-07 6.6kg sa 3yr



61-07 6.0kg sa 3yr    59-07 5.9kg sa 3yr    123-07 6.04kg sa 3yr



194-09 5.0kg 2yr    91-09 4.5kg 2yr    84-09 5.2kg 2yr



194-09 7.55kg @ 3yr and National Champion



95-11 7kg @ 2yr

Everest breeds very heavy tidy velvet that is proven by breeding a 2yr and 3yr old National Velvet champion here at Altrive.

Purchased for \$50,000 with Brock Deer.

From his 1st drop in 2007 Everest had 17 stag fawns:

- 9 sold as 2yr velvet stags
- 1 sold as 2yr sire stags
- 7 kept to 3yr sale

<b>Tag# / Name</b>	Everest 341-04
<b>Spiker</b>	
<b>Velvet 2 year</b>	
<b>Velvet 3 year</b>	7.6kg
<b>Velvet 5 year</b>	9.8kg
<b>Velvet 6 year</b>	10.65kg
<b>Velvet 9 year</b>	12.25kg
<b>Notes</b>	Breeding very correct velvet. Everest Sons from first mating: ALT 53-07 6.2kg SA @2yr Sold \$17,000 Tower farms 2yr Champion Won North Island 3yr ALT 61-07 6.0kg SA @ 3yr Sold \$10,500 ALT 76-07 6.6kg SA @ 3yr Sold \$10,500 ALT 59-07 5.9kg SA @ 3yr Sold \$6500 ALT 77-07 7.46kg SA Retained in stud 8.24kg 4yr 2nd place Nationals

### Pedigree

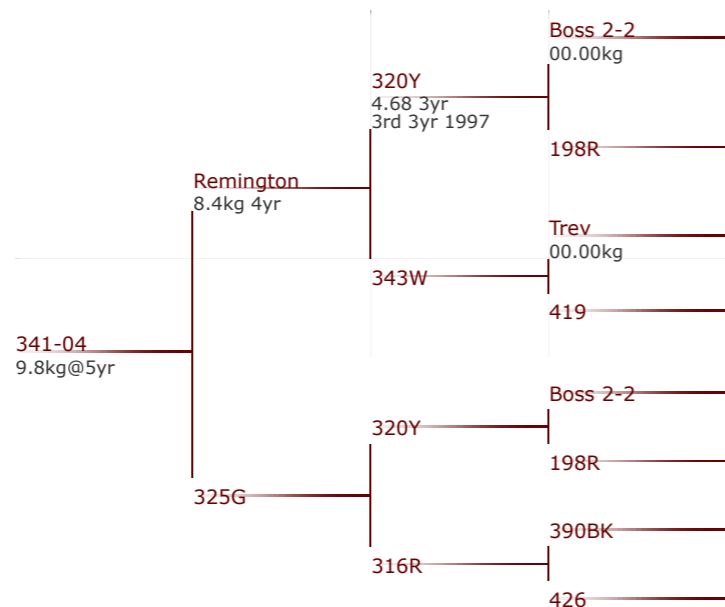

## Zama 74-06

Zama was purchased for \$30,000. He is jointly owned with Brock Deer.



74-06 11.3kg Winner of National Open, Grand Champion and People's Choice, 2012 at 6yr



2009 Nationals



2 yr head 30 point ha



Zama - growing out 2011

<b>Tag# / Name</b>	74-06 / Zama
<b>Weaner weight</b>	
<b>Velvet 3 year</b>	7.66kg 3 yr Won National 3 yr velvet competition
<b>Velvet 4 year</b>	Grown out 4 yr 422 IOA
<b>Velvet 5 year</b>	Grown out 5 yr 478 IOA
<b>Velvet 6 year</b>	11.3kg Winner of National Open, Grand Champion and People's Choice, 2012
<b>Velvet 7 year</b>	12.25kg
<b>Notes</b>	First 2 yr sons born 2009 averaged 4kg

### Pedigree

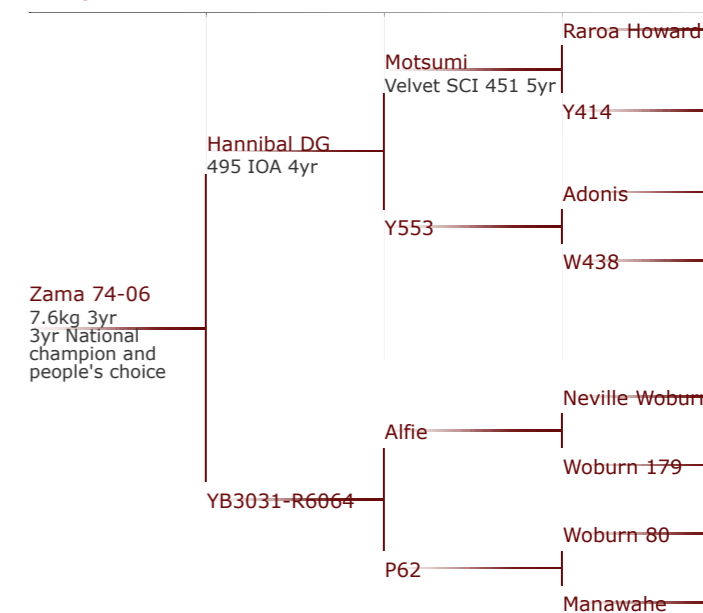

### Progeny of Zama 74-06



111-09    111-09 4.6kg 2yr    142-09 4.65kg 2yr    76-09 6kg 2yr



### David 230-98

David cut 11kg @9yr and sired 123-04 502 IOA @4yr.

Also sired 186-04 sold as sire to Alan Stewart \$20000.

Has left 3yr olds cutting up to 8kg of velvet.



Full head of David x Thomas Albert



David - 11kg 6th Open 2009

#### Progeny of David 230-98



186-04 David + Son 123-04



113-07 tw 6.52kg sa 3yr 99-10 5.7kg 2yr



99-10 Spiker 99-10 Spiker 99-10 Spiker 6.1kg

<b>Tag# / Name</b>	230-98 / David
<b>Weaner weight</b>	
<b>Velvet 2 year</b>	
<b>Velvet 11 year</b>	11kg sa
<b>Notes</b>	

#### Pedigree

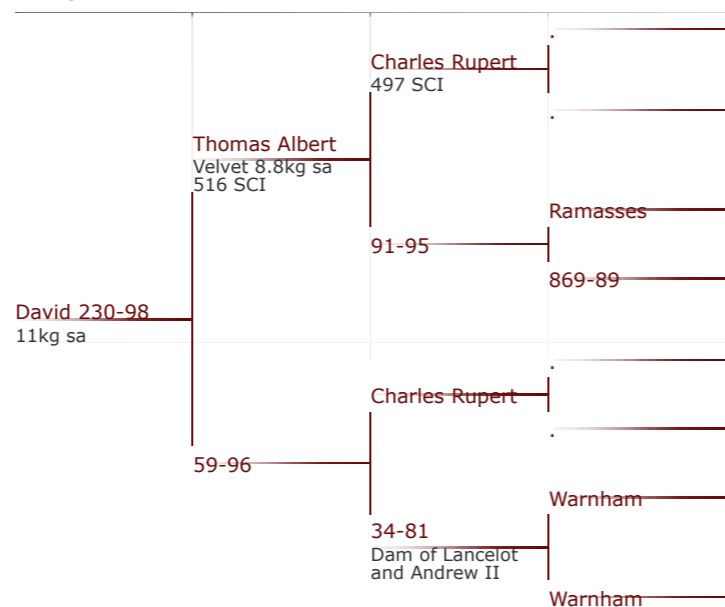

### Altrive 81-06



81-06 8.45kg sa 4yr 2nd National 2yr competition Winner National 4yr Competition



103-08 5.6kg sa 2yr. Full brother of 81-06

#### Progeny of 81-06



229-10 4.65kg 2yr 262-10 4.8kg 2yr 229-10 7.6kg 3yr



020-11 6.7kg 3yr 219-11 6.5kg 3yr 222-10 9.1kg 4yr



294-12 5.45kg SA 2yr

<b>Tag# / Name</b>	81-06
<b>Weaner weight</b>	79kg
<b>Velvet 2 year</b>	5.7kg 2nd National 2yr velvet Competition
<b>Velvet 3 year</b>	7.3kg
<b>Velvet 4 year</b>	8.45 kg 4 yr 4 yr National velvet champ First 2 yr sons velveted Dec 2011
<b>Velvet 5 year</b>	
<b>Velvet 6 year</b>	11.0kg
<b>Velvet 7 year</b>	11.8kg
<b>Notes</b>	

#### Pedigree

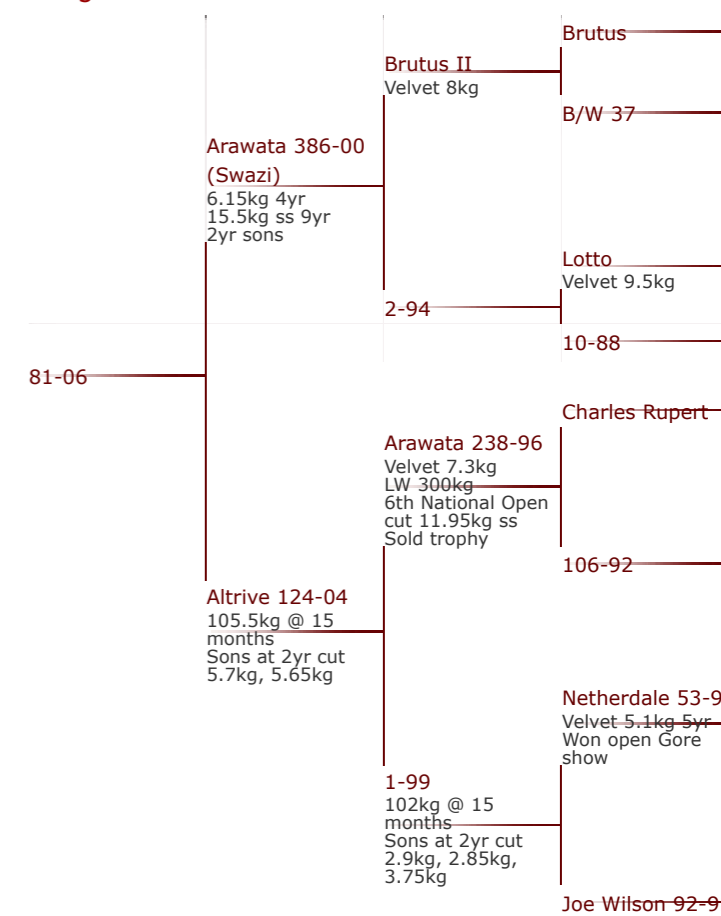

### Altrive 77-07

First 2 yr sons are due to be velveted December 2013.



Altrive 77-07 - 8.24kg sa 4yr - 2nd place Nationals 2011 x Everest.  
10kg @ 6 yr

#### Progeny of 77-07

77-07 has no photos of progeny yet.

<b>Tag# / Name</b>	77-07
<b>Weaner weight</b>	
<b>Velvet 2 year</b>	4.35kg
<b>Velvet 3 year</b>	7.46kg
<b>Velvet 6 year</b>	10.00kg
<b>Notes</b>	Very strong Dam line for velvet. Check out other Everest sons on <a href="#">Everest</a> page.

#### Pedigree

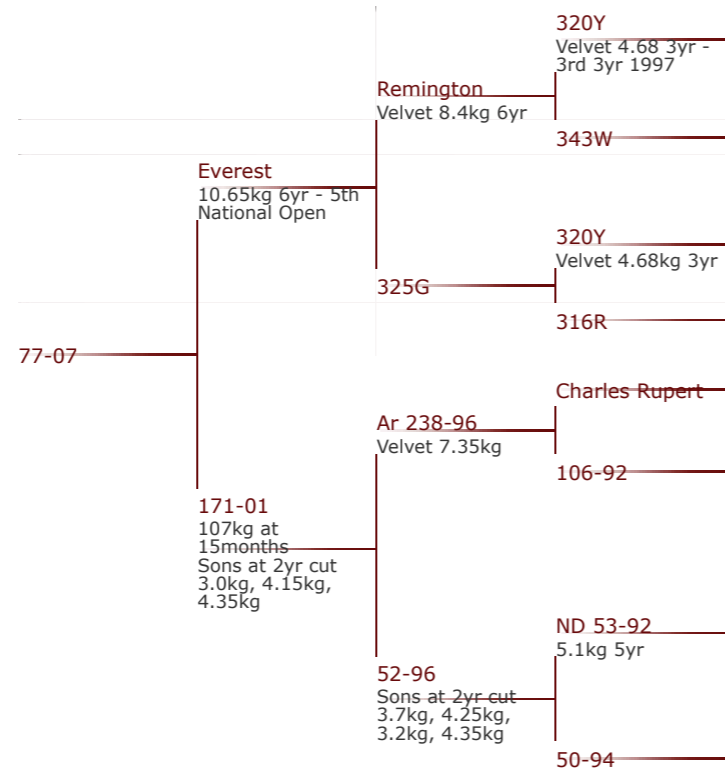

### Arawata Swazi 386-00

Purchased for \$30,000 with Brock Deer and E Tayles

Swazi's complete drop of 2 yr sons had an average weight of 3.51kg in 2007 and 3.72kg in 2008.



Altrive sire stag - Arawata Swazi 386-00. 14.3kg SS 8yr.

<b>Tag# / Name</b>	386-00 Arawata Swazi
<b>Weaner weight</b>	
<b>Velvet 3 year</b>	5.2kg
<b>Velvet 4 year</b>	6.0kg
<b>Velvet 9 year</b>	15.5kg SS
<b>Notes</b>	Very good Sire that mated well with all Dam lines



5.2kg 3yr

#### Progeny of 386-00



81-06 8.45kg sa 4yr 103-08 5.65kg sa 2yr 20-06 7.3kg 3yr

#### Pedigree

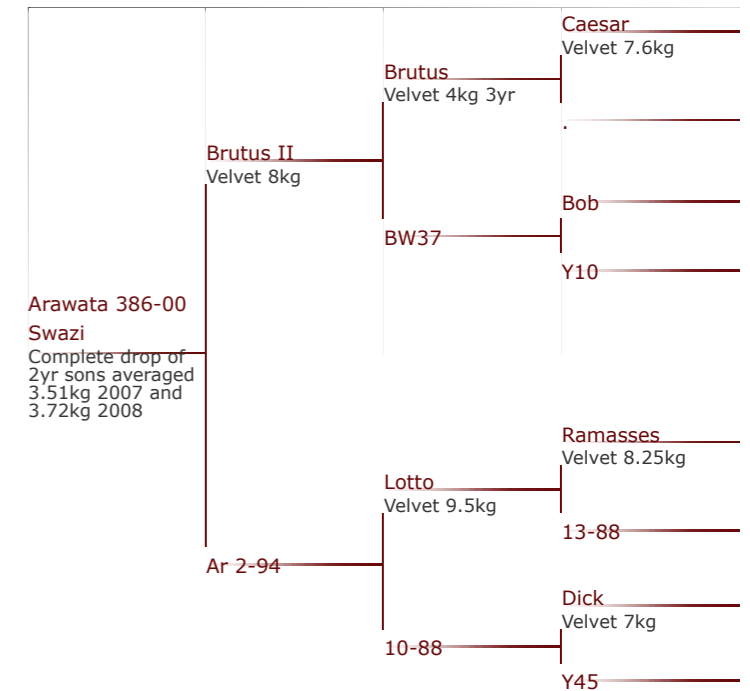



### Altrive 123-04

Trophy 2yr son sold for \$12000 and breeds good velvet with 3yr sons over 7kg.

4.2 kg SA 2 yr 3rd Southland 2 yr competition

5.2 kg SA 3 yr

Scored 502 IOA @ 4yr and breeds very good velvet and trophy heads as can be seen in the progeny photos below.



123-04

<b>Tag# / Name</b>	123-04 David Son (deceased)
<b>Weaner weight</b>	62kg
<b>2 year</b>	200kg
<b>Velvet weight 2yr</b>	4.2kg
<b>Notes</b>	Now deceased



4.2 kg SA 2 yr

#### Progeny of 123-04



196-07 7.3kg sa 3yr 162-07 5.95kg sa 3yr 242-09 Spiker



56-10 4.6kg 2yr 171-10 4.45kg 2yr 41-10 Trophy@2yr



243-09 10.55kg 243-09 10.55kg 243-09 6.55kg cut 1.11

#### Pedigree

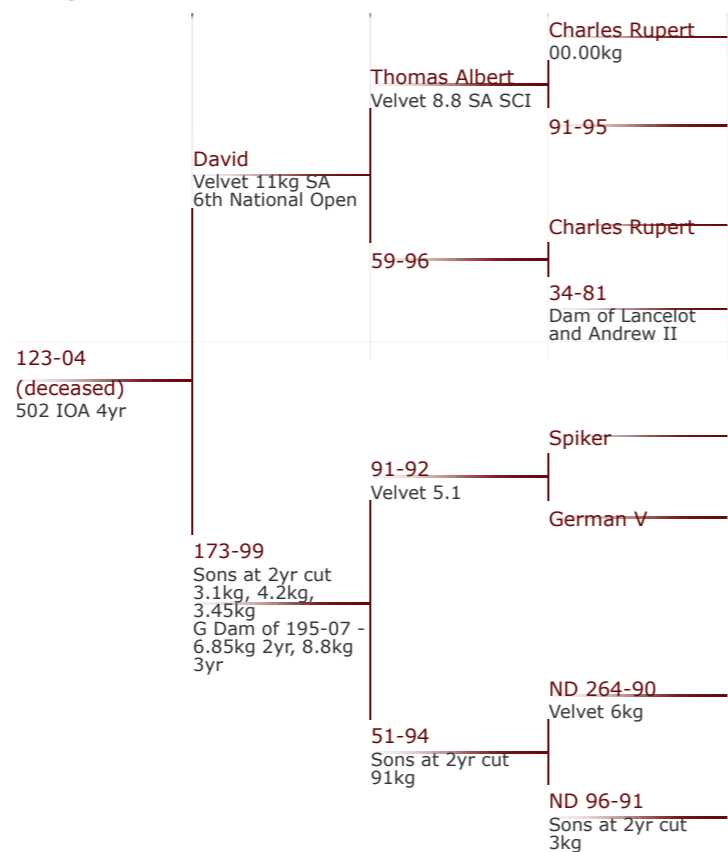

### Arawata 238-96 - Altrive sire stag

238-96 cut 7.35kg 7yr and bred very well for us with a lot of his sons sold as trophy stags and his daughters breed well.



7.35kg SA 7 yr 11.95kg SS 8 yr 300kg Live weight



7.35kg 7yr (6th Nat Open)

#### Progeny of 238-96



78-02 10kg ss 6yr 78-02 485 sci 78-02 7.65 5yr 47-04 10.2kg ss 261-03 10.25kg ss 136-03 6.8kg 4yr 4 Sons of 238-96

#### Pedigree

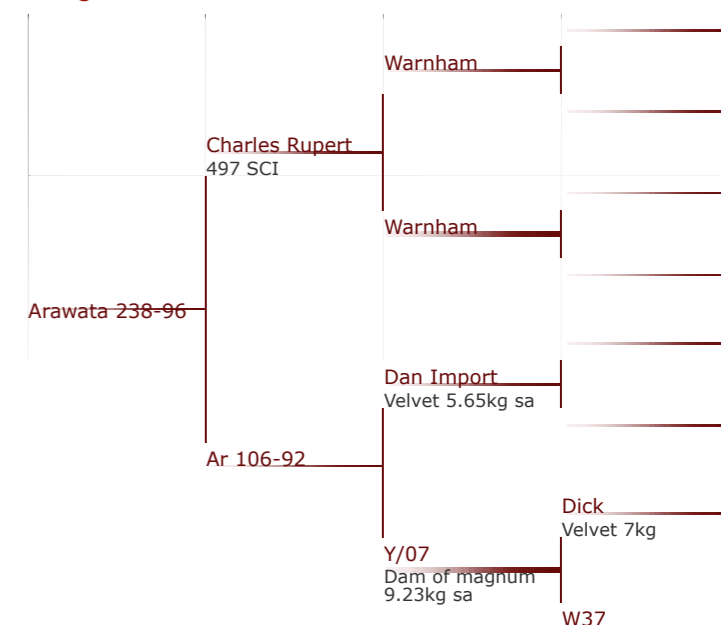

### Altrive 78-02



7.65 5yr



10kg ss 6yr / 11.65kg ss 7yr



Full head 78-02 Dec 2010  
485 SCI

#### Progeny of 78-02



82-06 7.36kg 3yr    224-10 4.55kg 2yr

<b>Tag# / Name</b>	78-02
<b>Weaner weight</b>	
<b>Velvet 3 year</b>	5.15kg SA
<b>Velvet 4 year</b>	6.5kg SA
<b>Velvet 5 year</b>	7.65kg SA
<b>Velvet 9 year</b>	11.65kg SA
<b>Notes</b>	Son of <a href="#">238-96</a>

#### Pedigree

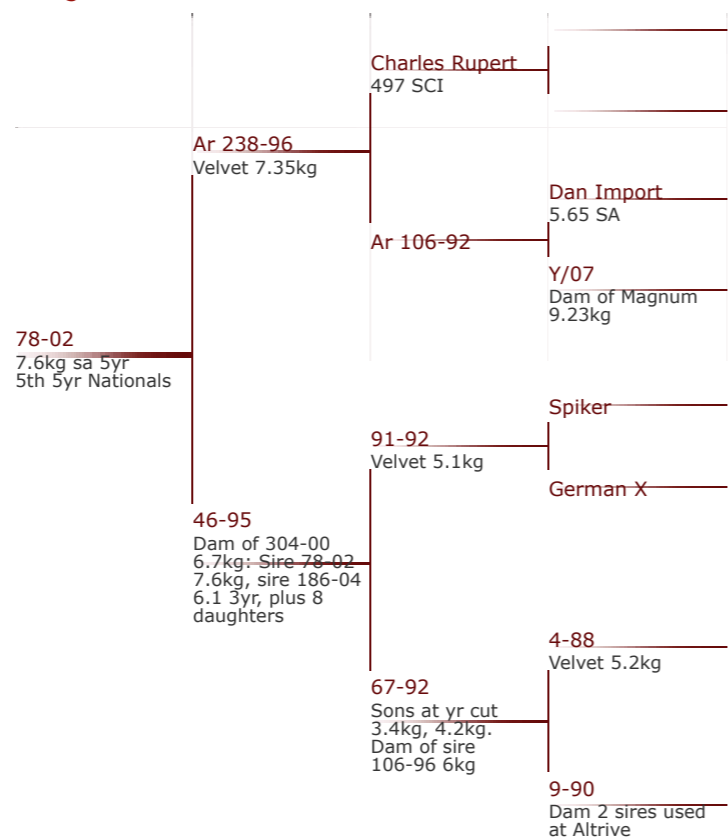

Altrive 186-04 Sire Stag

#### Progeny of 186-04



195-07 8.8kg sa 3yr

### Altrive 186-04

<b>Tag # / Name</b>	186-04
<b>Weaner weight</b>	
<b>Velvet 2 year</b>	4.85kg SA
<b>Velvet 3 year</b>	6.1kg SA
<b>Velvet 4 year</b>	10kg SS
<b>Notes</b>	Only used as two year old

#### Pedigree

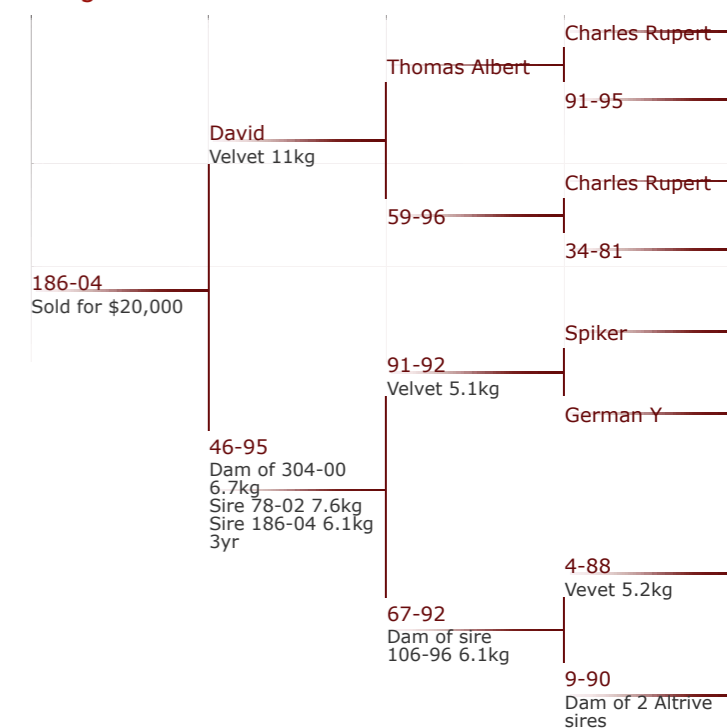



### Gloriavale 352-08

Spiker 20 point 300plus IOA.

#### Progeny of 352-08

We have no photos of 352-08's progeny at present.

<b>Tag# / Name</b>	352-08
<b>Weaner weight</b>	
<b>2 year live weight</b>	174kg
<b>Velvet 2 year</b>	Full head
<b>Notes</b>	

#### Pedigree

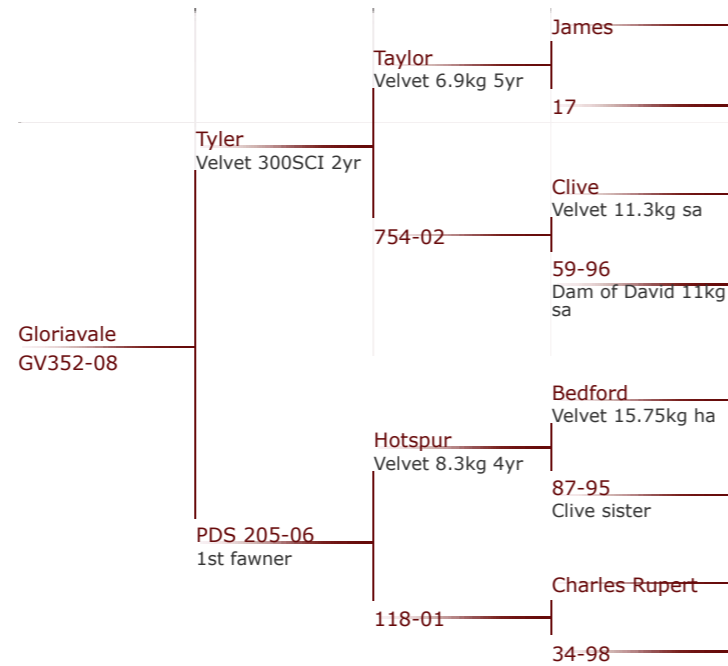

191-09 grown out @ 3 years

### FOV 191-09

This stag was purchased in 2012 as a 2yr old from Foveran. An Amadeus son with very correct head weighing 10kg HA. Bought to add trophy tops to our stags.

3yr head looking very good.

<b>Tag# / Name</b>	FOV 191-09
<b>Spiker</b>	
<b>Velvet 2 year</b>	10kg HA
<b>Velvet 3 year</b>	
<b>Velvet 5 year</b>	
<b>Velvet 6 year</b>	
<b>Notes</b>	Weaned weight 66kg, 200kg @ 2yr. Grown out at 3 yr.

#### Pedigree

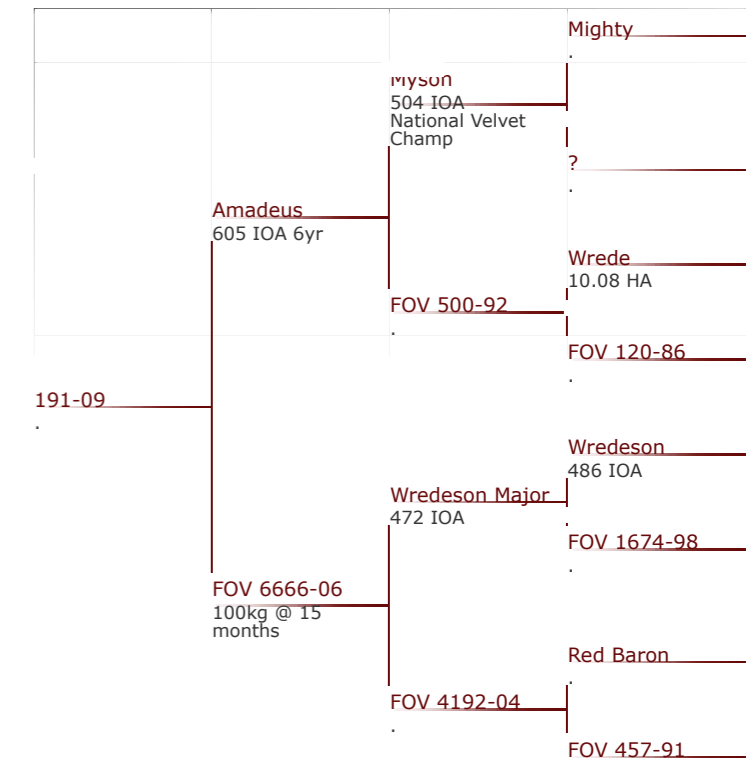

### Altrive 95-11



95-11 7.0kg @ 2yr



95-11 8.6kg @ 3yr

<b>Tag# / Name</b>	95-11
<b>Weaner weight</b>	
<b>Velvet 2 year</b>	7.0kg
<b>Velvet 3 year</b>	8.6kg
<b>Velvet 4 year</b>	
<b>Velvet 5 year</b>	
<b>Velvet 6 year</b>	
<b>Velvet 7 year</b>	
<b>Notes</b>	

#### Pedigree

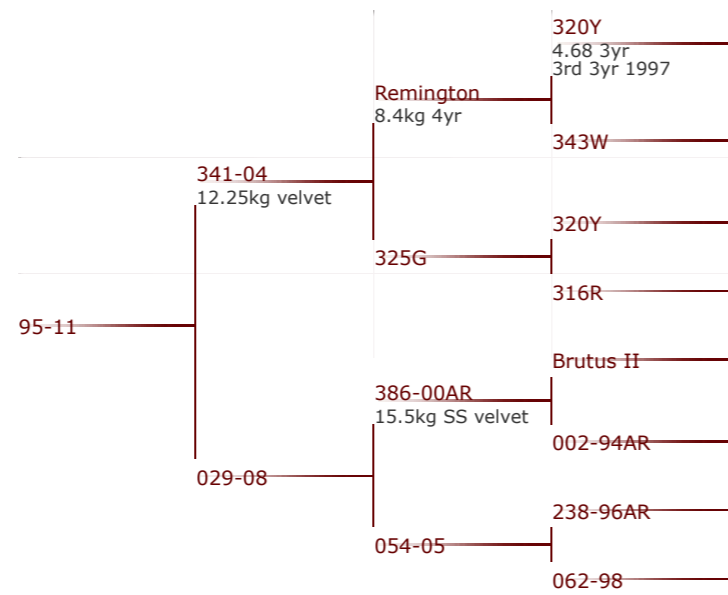

### 765-10

#### Progeny of 765-10

We have no photos of 765-10's progeny at present.

<b>Tag# / Name</b>	765-10
<b>Weaner weight</b>	
<b>Velvet 2 year</b>	7.8kg SA
<b>Velvet 3 year</b>	8.1kg SA
<b>Velvet 4 year</b>	
<b>Velvet 5 year</b>	
<b>Velvet 6 year</b>	
<b>Velvet 7 year</b>	
<b>Notes</b>	

#### Pedigree

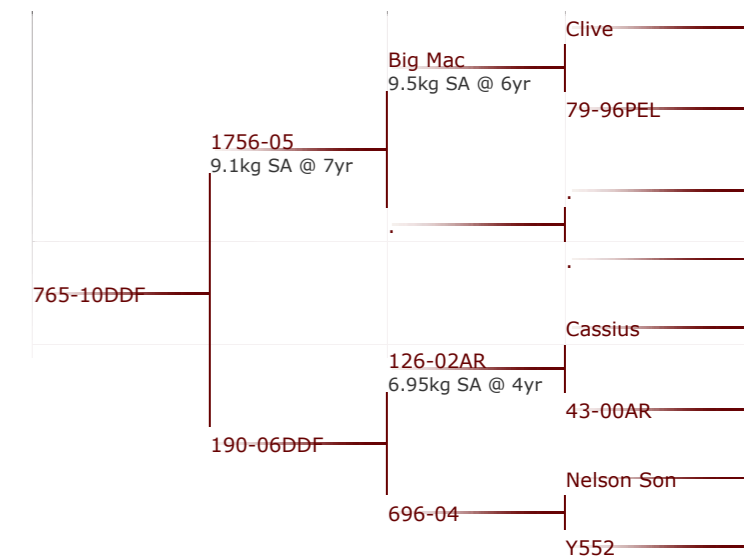



## lot # 1 – 3yr sire stag



Animal: **11-171**

Birthdate: 2011

Weigh Date	Weight
2/04/2012	76 kg
31/01/2013	146 kg
20/01/2014	194 kg

Velvet Date	Weight	Grade
1/11/2014	6.65	
1/12/2013	5.30	

3yr Velvet weight: 6.65kg

### Pedigree:

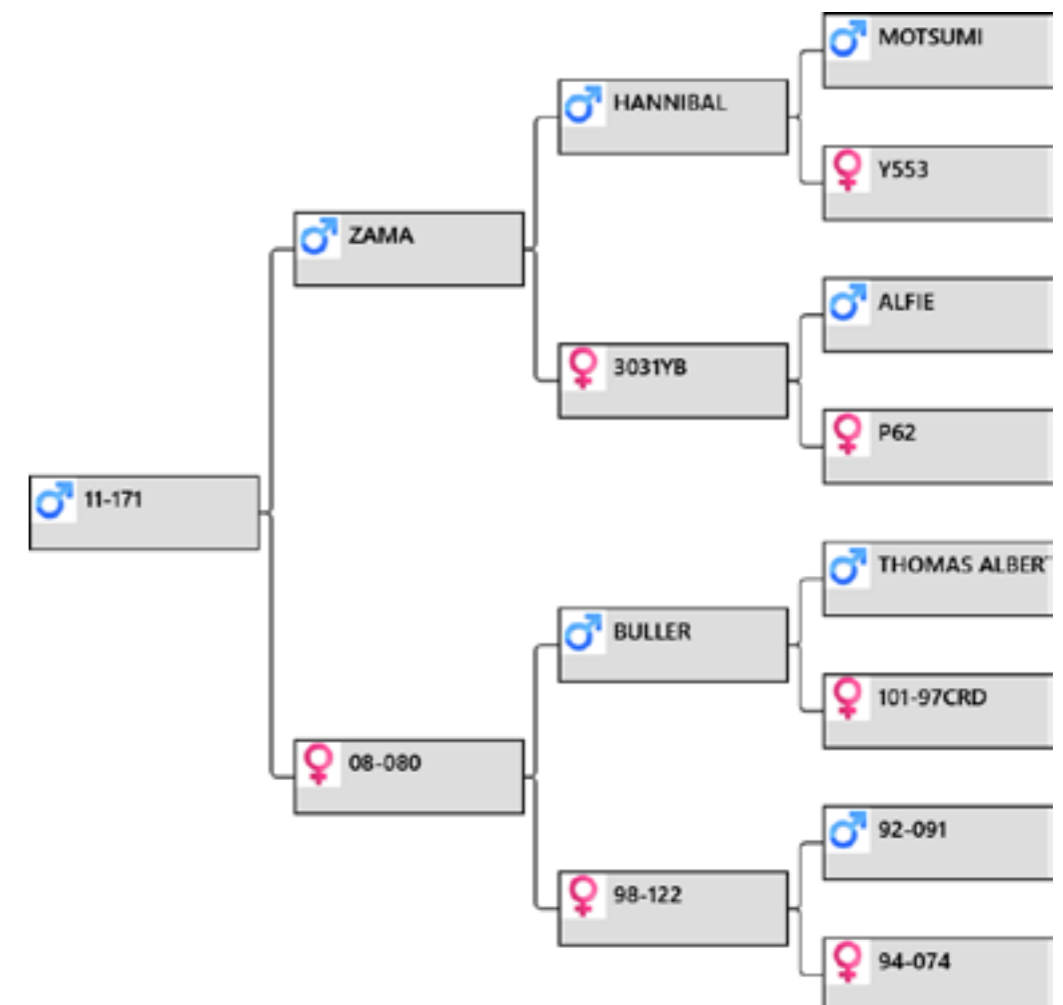

### Biography:

Very correct clean velvet with good bulbs on this big son of Zama, national velvet champion 2012. HE is out of a top Buller daughter that we have used as a donor hind. Grand dam 122-98 is the dam of 130-04 sold as sire and lot 10 2013 \$8800 and she is the grand dam of 53-07 6.2kg SA national 2yr velvet champion and sold for \$17000

3yr weight 15/12/14 234kg

Sale weight:

Price:

Buyer:

## lot # 2 – 3yr sire stag



Animal: **11-020**

Birthdate: 2011

Weigh Date	Weight
2/04/2012	71 kg
31/01/2013	132 kg
20/01/2014	178 kg

Velvet Date	Weight	Grade
1/11/2014	6.70	
1/12/2013	5.70	

3yr Velvet weight: 6.7kg

### Pedigree:

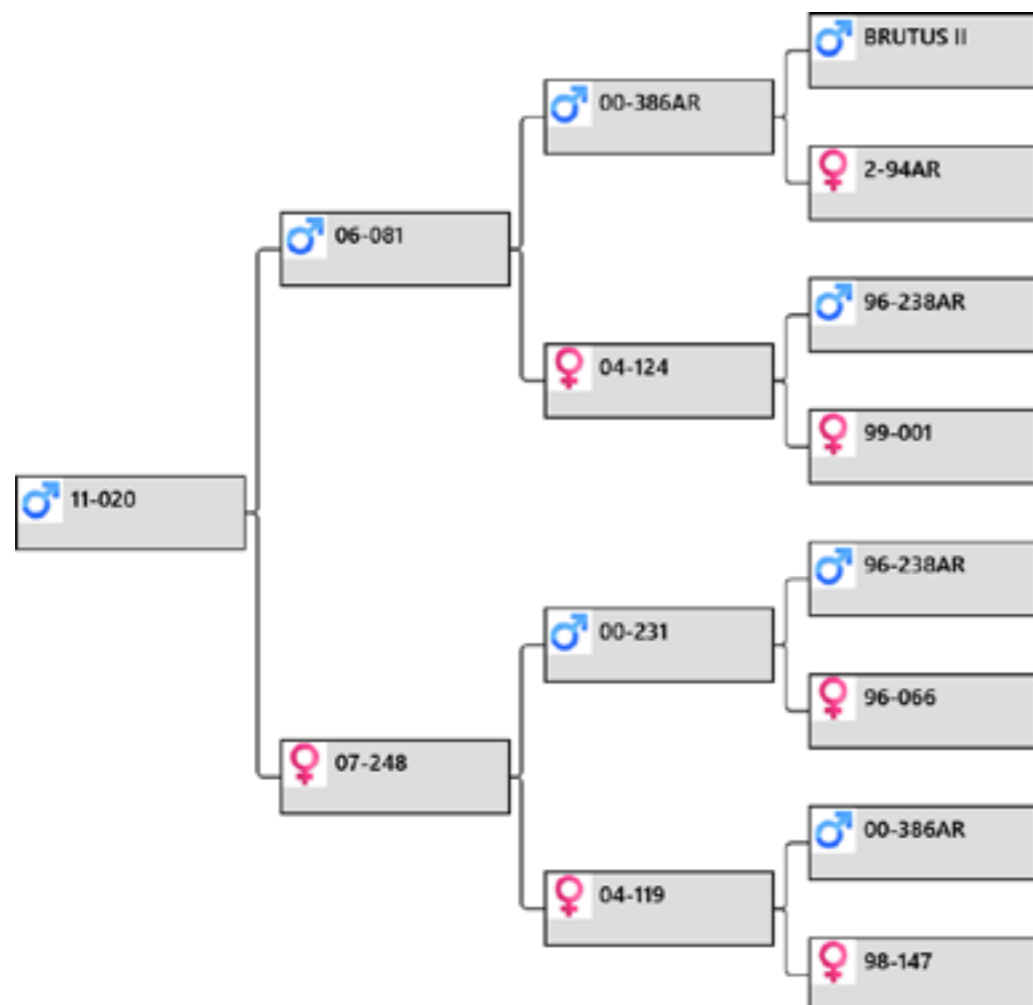

### Biography:

Good tidy velvet on this stag by Altrive 81-06 national 4yr old champion and 11.8kg SA 7yr. (81-06 is proving to bred on just as well as Zama and Everest and he is the sire of lot #1 last year sold for \$20000). 20-11 is out of top hind 248-07 also dam of full brother 222-10 9.1kg @ 4yr. 147-98 had a son sold lot 6 2012 with a very correct 6kg head. 3yr weight 15/12/14 214kg

Sale weight: Price: Buyer:

## lot # 3 – 3yr sire stag



Animal: **11-219**

Birthdate: 2011

Weigh Date	Weight
2/04/2012	75 kg
31/01/2013	131 kg
20/01/2014	170 kg

Velvet Date	Weight	Grade
1/11/2014	6.50	
1/12/2013	4.45	

3yr Velvet weight: 6.5kg

### Pedigree:

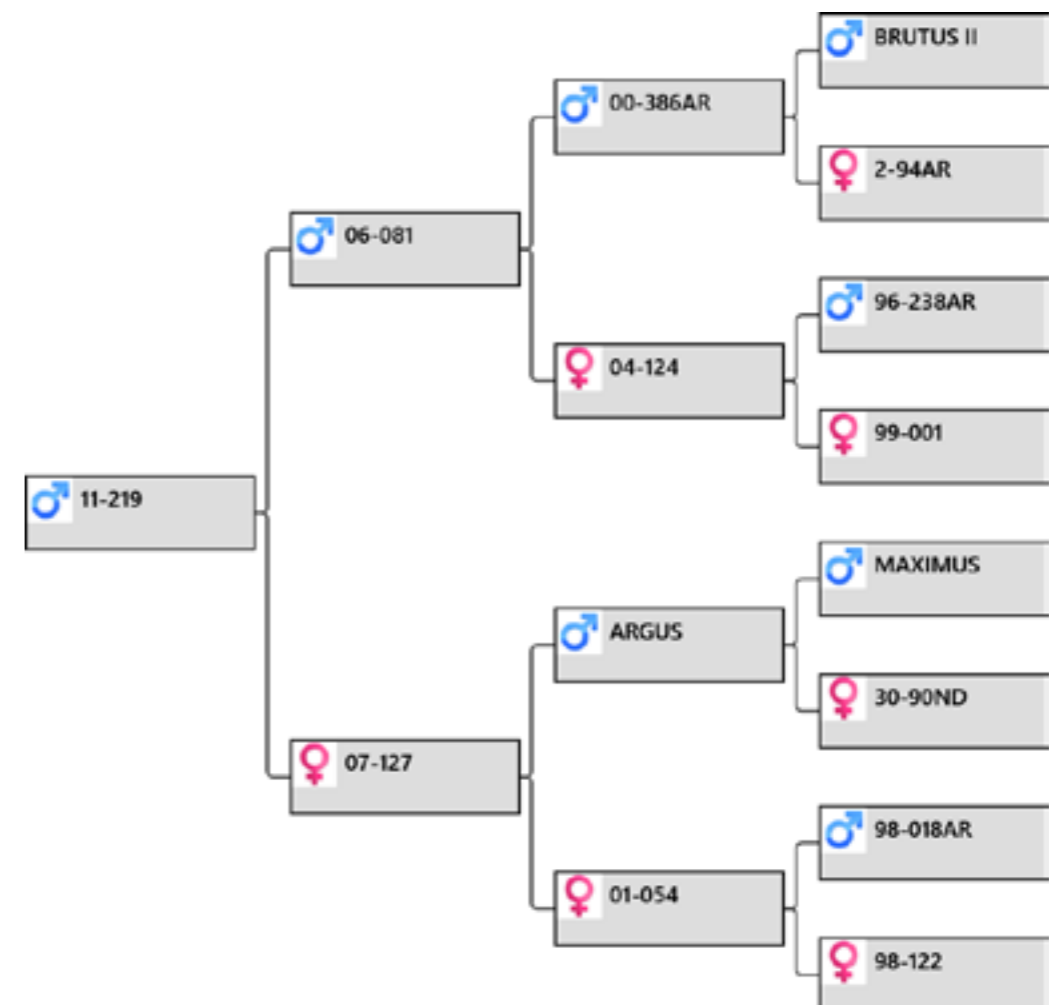

### Biography:

Very correct clean head on another son of 81-06 out of 127-07 who has only had this one son and 4 daughters but her dam 54-01 has had 3 sons sold at auction. 122-98 is in the bottom line of lot one as well. She is the dam of 130-04 sold as sire and lot 10 2013 \$8800 and is the grand dam of 53-07 6.2kg 2yr national velvet champion sold for \$17000. 3yr weight 15/12/14 208kg

Sale weight: Price: Buyer:

## lot # 4 – 3yr sire stag



Animal: **11-103**

Birthdate: 2011

Weigh Date	Weight
2/04/2012	68 kg
31/01/2013	132 kg
20/01/2014	160 kg

Velvet Date	Weight	Grade
1/11/2014	7.25	
1/12/2013	4.50	

3yr Velvet weight: 7.25kg

### Pedigree:

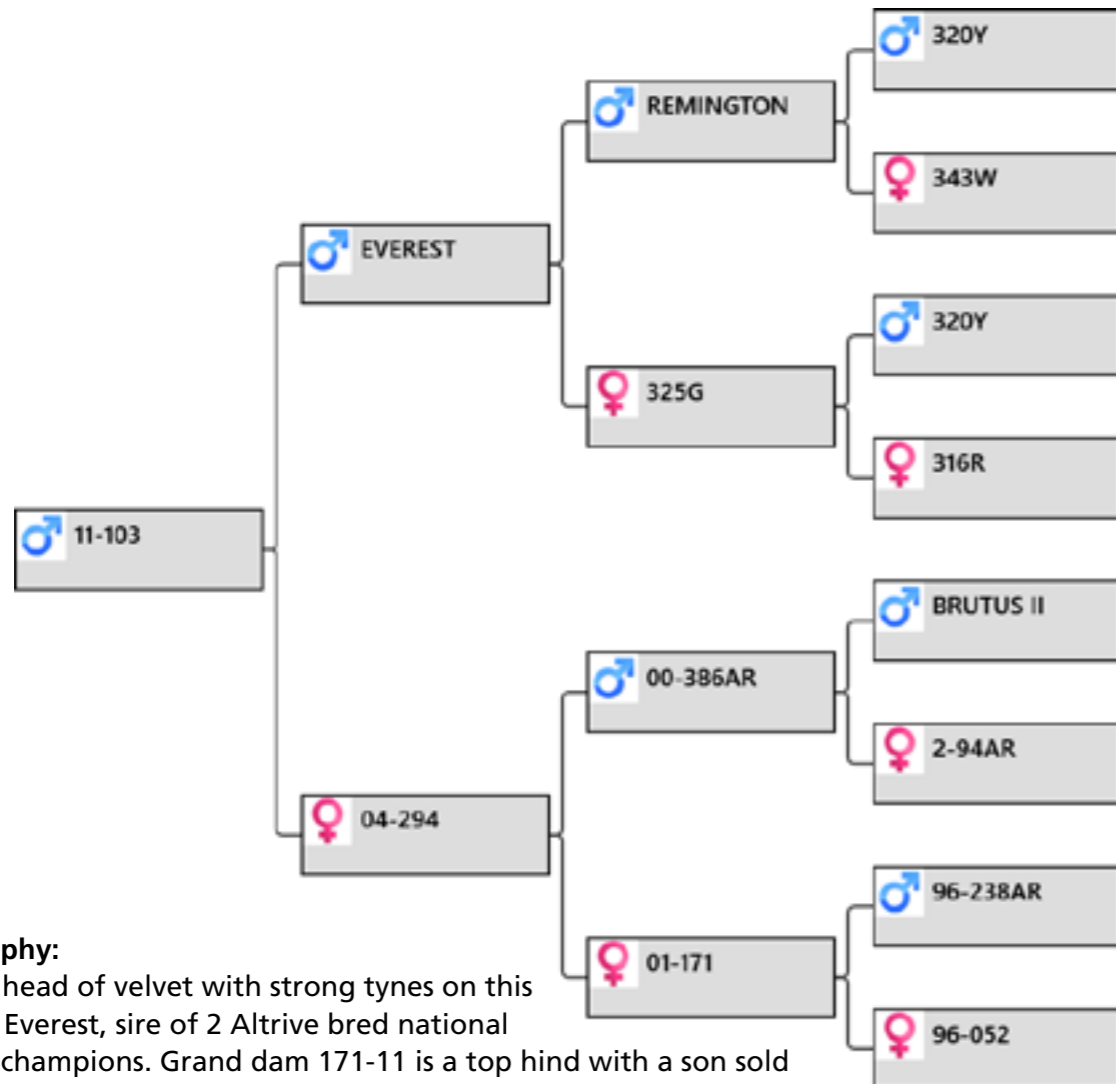

### Biography:

Heavy head of velvet with strong tynes on this son of Everest, sire of 2 Altrive bred national velvet champions. Grand dam 171-11 is a top hind with a son sold 2014 auction and she is the dam of sire 77-07 who was placed 2nd in national 4yr competition and went on to cut 10kg @ 6yr. He has left very good sons and we sold him to Regan Blair last year for \$15000. Only sold as he is by Everest and we were making room for 95-11 by Everest 7kg @2yr and 8.6kg 3yr. 52-96 had a son used in the stud plus a 2yr old cutting 4.35kg and another cutting 4.25kg. 3yr weight 15/12/14 196kg

Sale weight: Price: Buyer:

## lot # 5 – 3yr sire stag



Animal: **11-258**

Birthdate: 2011

Weigh Date	Weight
2/04/2012	62 kg
31/01/2013	129 kg
20/01/2014	200 kg

Velvet Date	Weight	Grade
1/12/2014	8.50	
1/12/2013	5.80	

3yr Velvet weight: 8.50kg

### Pedigree:

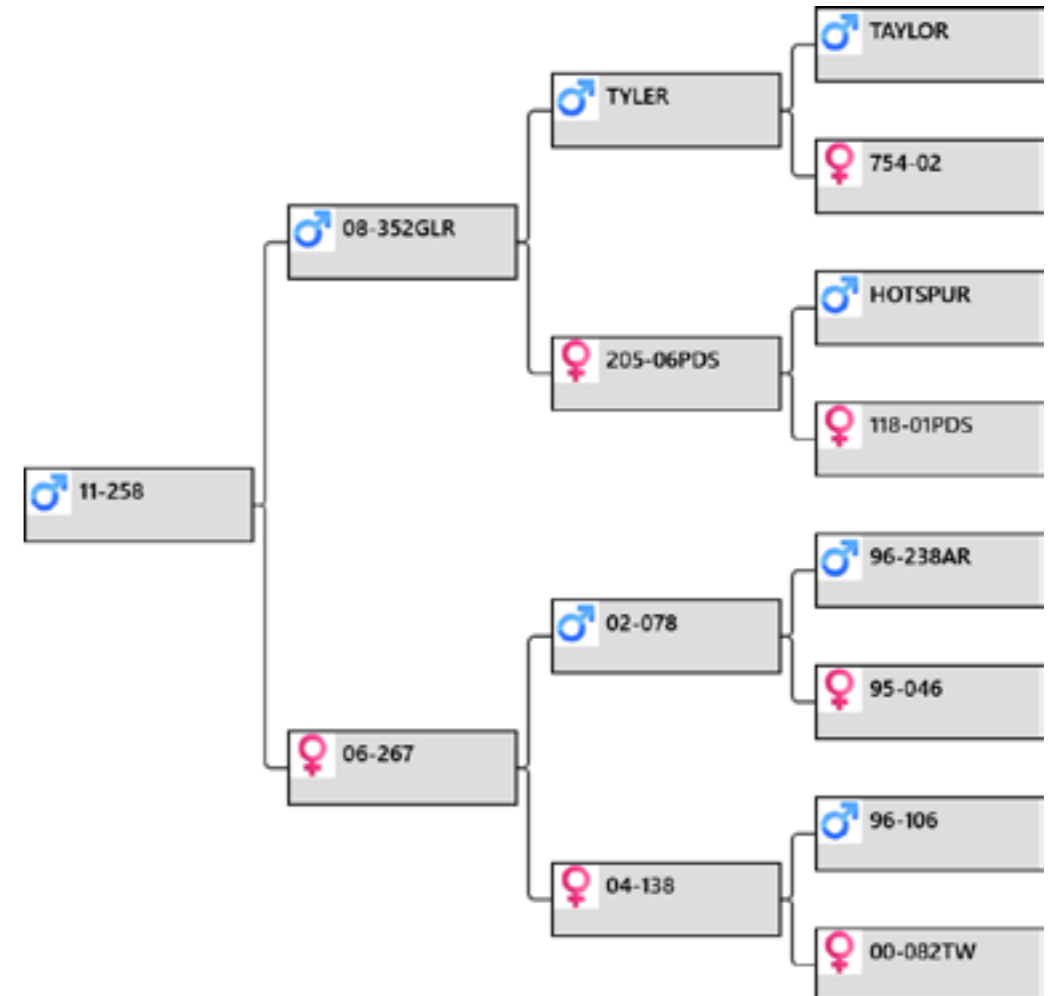

### Biography:

Good big stag with very heavy velvet 8.5kg @ only 3yr by GLR 352-08 9.75kg SA @5yr. 82-00 anchors this pedigree being dam of a son sold for \$4000 and one for \$15000 with 138-04 being full sister to the one for \$15000. 78-02 cut 7.65kg SA @5yr and scored 485 SCI @8yr. 3yr weight 15/12/14 222kg

Sale weight: Price: Buyer:



## lot # 6 – 3yr sire stag



Animal: **11-077**

Birthdate: 2011

Weigh Date	Weight
2/04/2012	75 kg
31/01/2013	130 kg
20/01/2014	180 kg

Velvet Date	Weight	Grade
1/12/2014	6.70	
1/12/2013	4.25	

3yr Velvet weight: 6.70kg

### Pedigree:

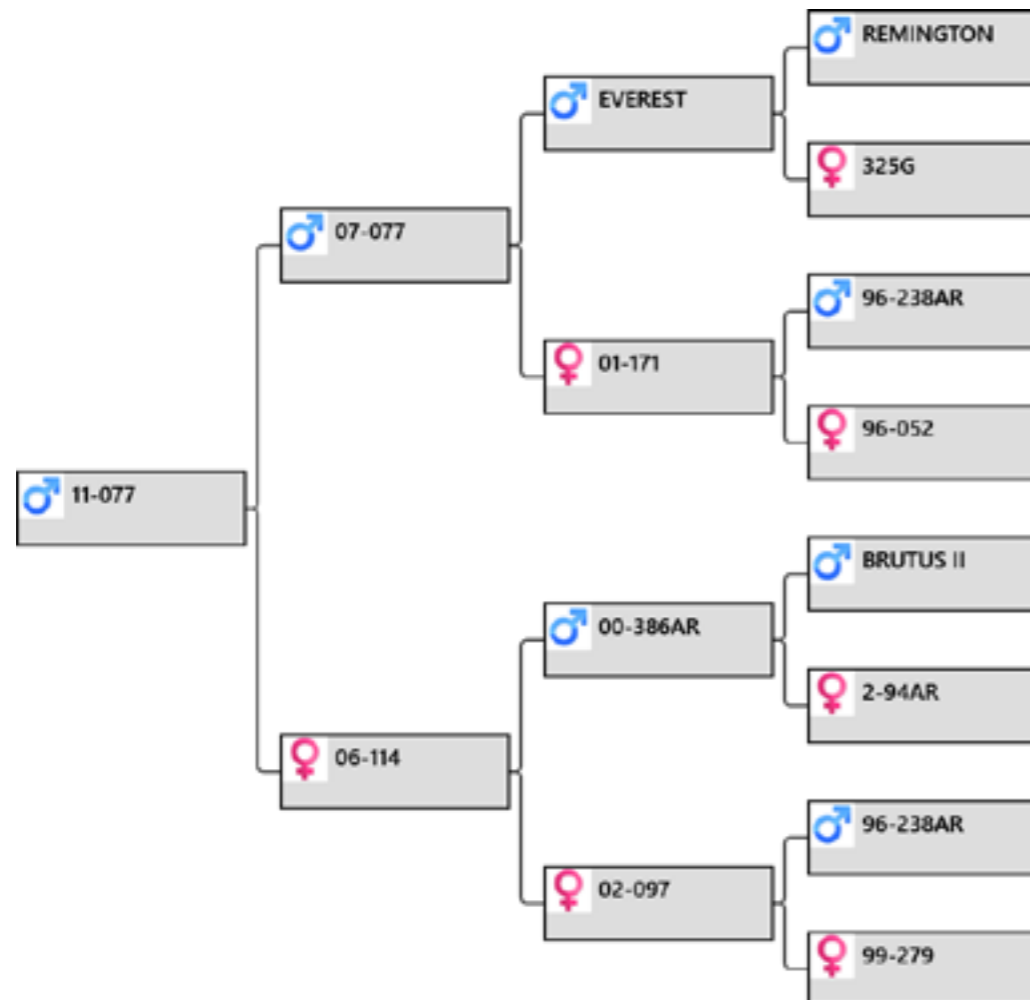

### Biography:

Very clean head of velvet with strong trezs by 77-07 10kg 6yr. Dam 114-06 had son sold \$4000 2013 sale  
3yr weight 15/12/14 212kg

Sale weight: Price: Buyer:

## lot # 7 – 3yr sire stag



Animal: **11-123**

Birthdate: 2011

Weigh Date	Weight
2/04/2012	71 kg
31/01/2013	124 kg
20/01/2014	180 kg

Velvet Date	Weight	Grade
1/11/2014	5.80	
1/12/2013	4.55	

3yr Velvet weight: 5.80kg

### Pedigree:

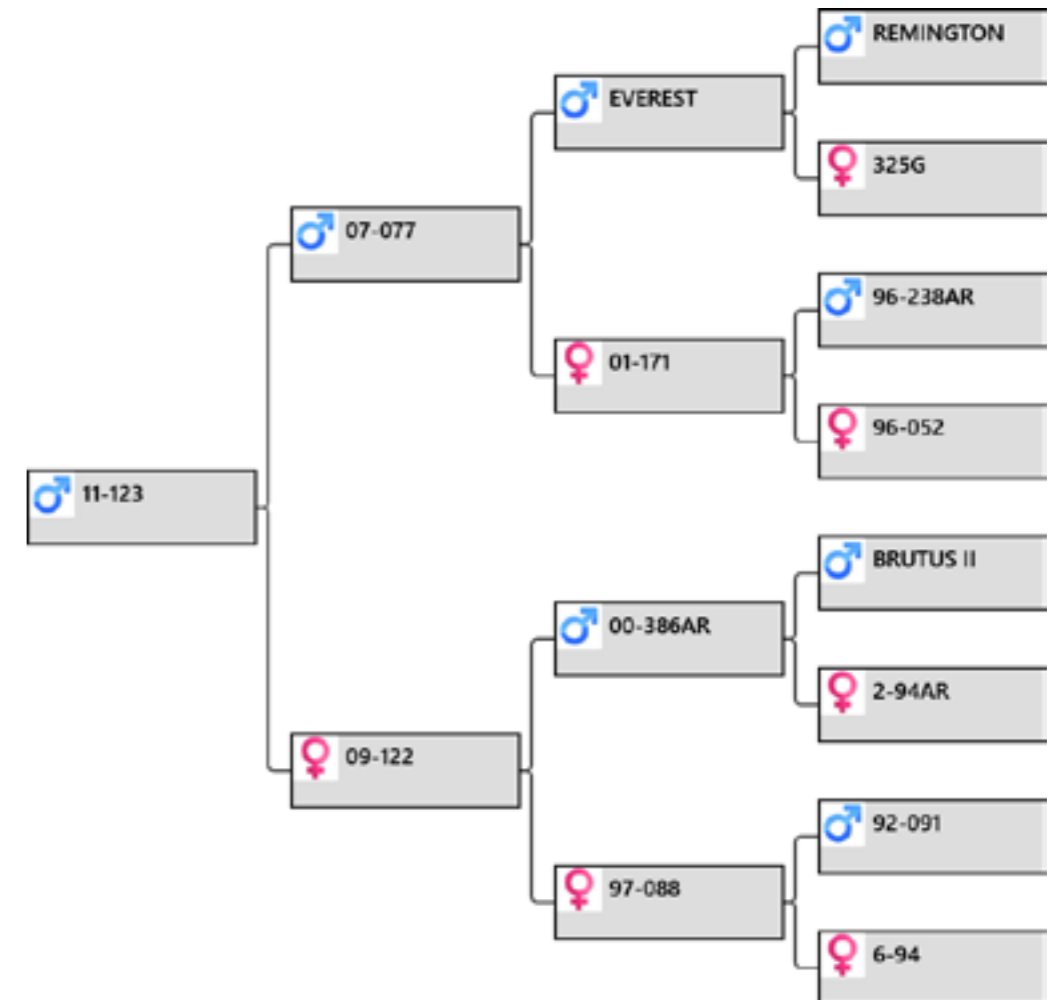

### Biography:

Another son by 77-07 10kg 6yr. Dam 122-09 first fawner and has 2 daughters since. 88-97 had a son cutting over 4kg @2yr  
3yr weight 15/12/14 223kg

Sale weight: Price: Buyer:

## lot # 8 – 3yr sire stag



Animal: **11-133**

Birthdate: 2011

Weigh Date	Weight
2/04/2012	65 kg
31/01/2013	127 kg
20/01/2014	181 kg

Velvet Date	Weight	Grade
1/12/2014	6.15	
1/12/2013	4.80	

3yr Velvet weight: 6.15kg

### Pedigree:

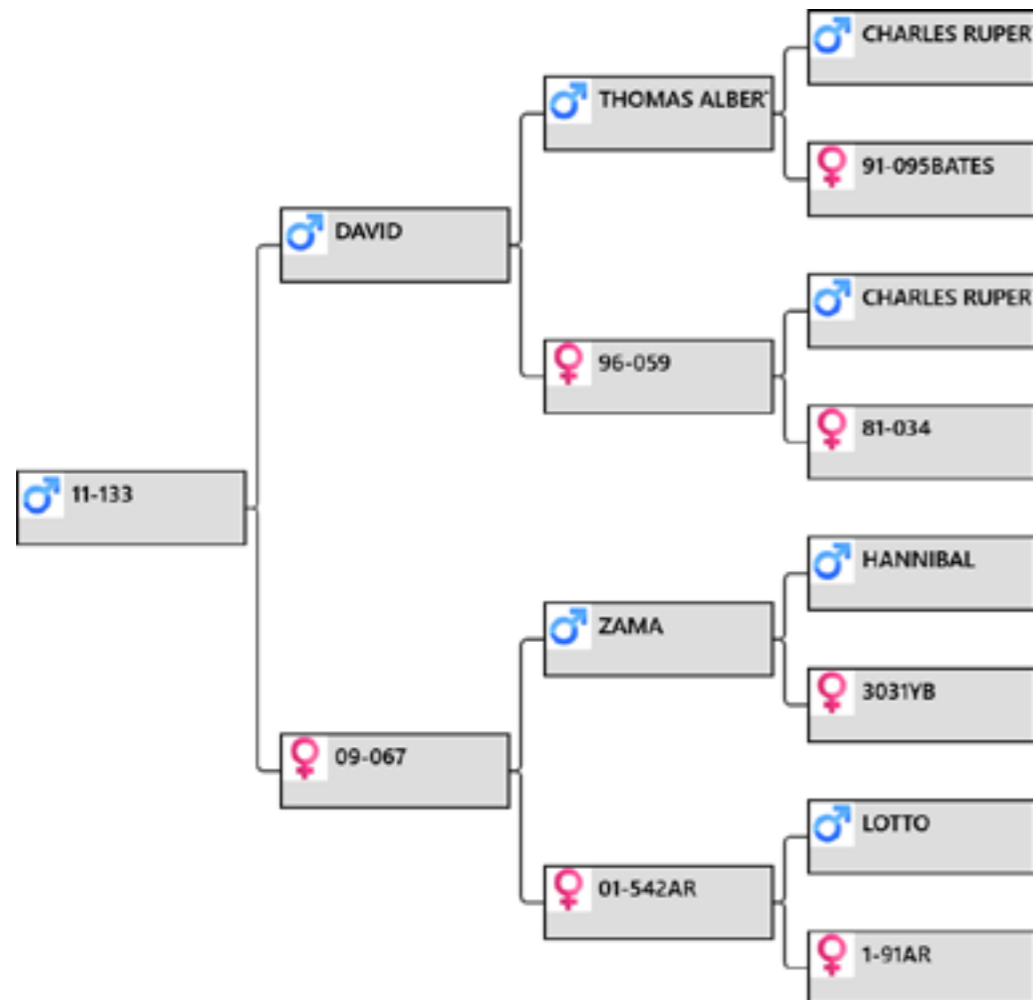

### Biography:

Very clean correct velvet on this stag by David 11kg SA out of a first fawner by Zama 12.25kg SA back to a top hind purchased from Arawata.  
3yr weight 15/12/14 200kg

Sale weight: Price: Buyer:

## lot # 9 – 3yr sire stag



Animal: **11-046**

Birthdate: 2011

Weigh Date	Weight
2/04/2012	62 kg
31/01/2013	115 kg
20/01/2014	170 kg

Velvet Date	Weight	Grade
1/11/2014	6.90	
1/12/2013	5.40	

3yr Velvet weight: 6.90kg

### Pedigree:

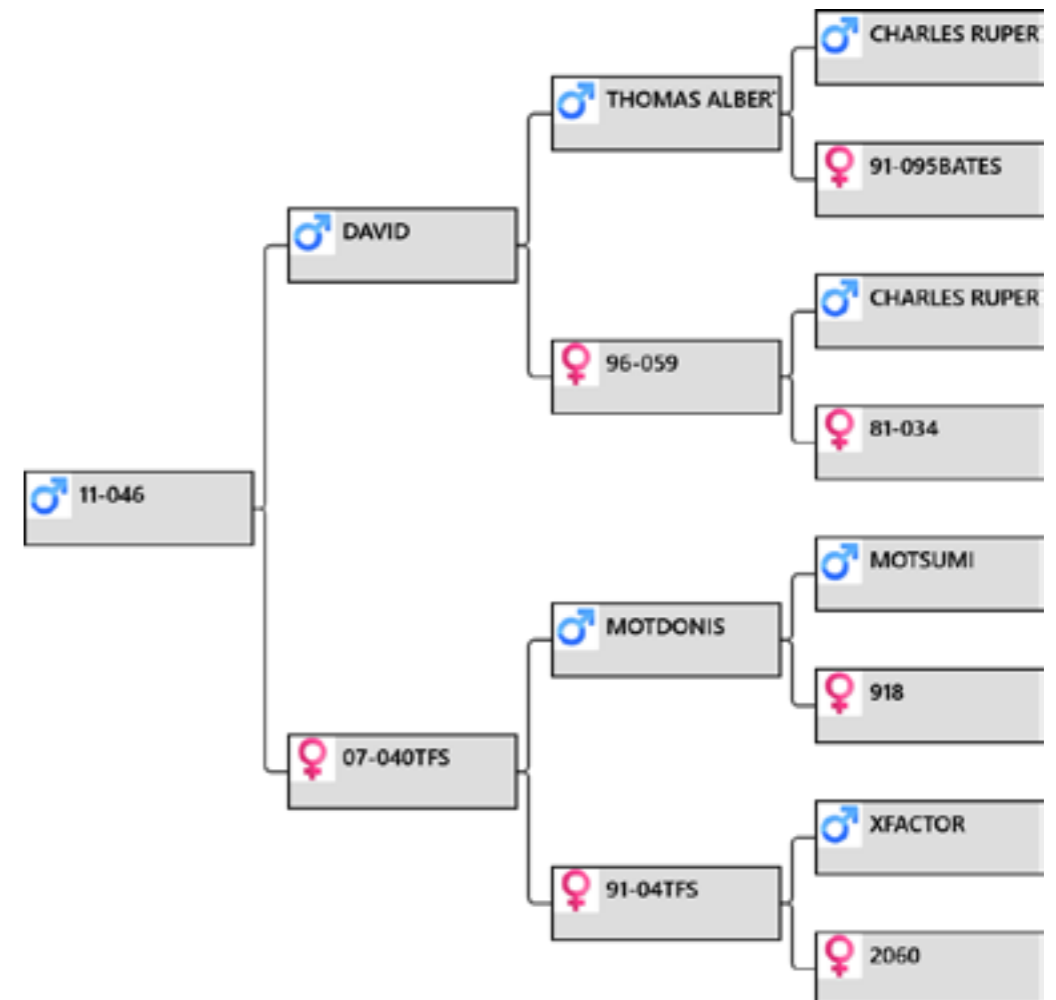

### Biography:

David again 11kg SA over a Tower farm Motdonis daughter 40-07. As catalogue goes to print we have just cut her 2yr old son 4-12 with a very nice head weighing 4.7kg.  
3yr weight 15/12/14 205kg

Sale weight: Price: Buyer:

## lot # 10 – 4yr sire stag



Animal: **10-222**

Birthdate: 2010

Weigh Date	Weight
4/04/2011	68 kg
31/01/2012	120 kg
19/01/2013	178 kg

Velvet Date	Weight	Grade
1/12/2013	6.55	
1/12/2012	4.20	

4yr Velvet weight: 9.1kg

### Pedigree:

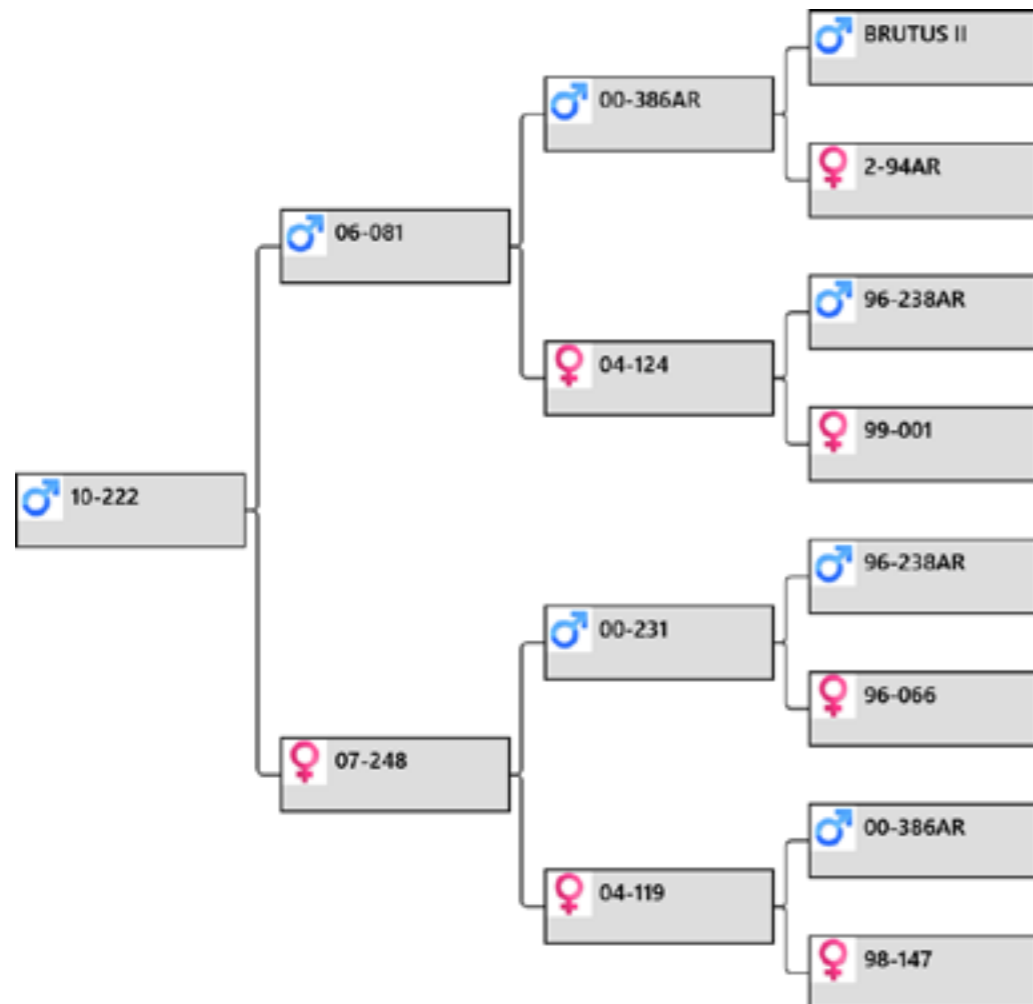

### Biography:

This 4yr old stag should have been in last years sale. We think his velvet must have been sold by mistake as we don't have a photo of it. He is certainly a good stag with a very big head 9.1 kg. He is a full brother to lot 2 20-11. His dam 248-07 certainly has top velvet genetics going back to 147-98 with a son sold 2012 sale. 81-06 11.8 kg SA back to AR 386-00 15.5kg SS velvet  
4yr weight 15/12/14 243kg

Sale weight: Price: Buyer:

## lot # 11 – 3yr sire stag



Animal: **11-199**

Birtdate: 2011

Weigh Date	Weight
2/04/2012	54.5kg
31/01/2013	128kg
20/01/2014	190kg

Velvet Date	Weight
1/12/2014	7.65kg
1/12/2013	5.15kg

3yr Velvet weight: 7.65kg

### Pedigree:

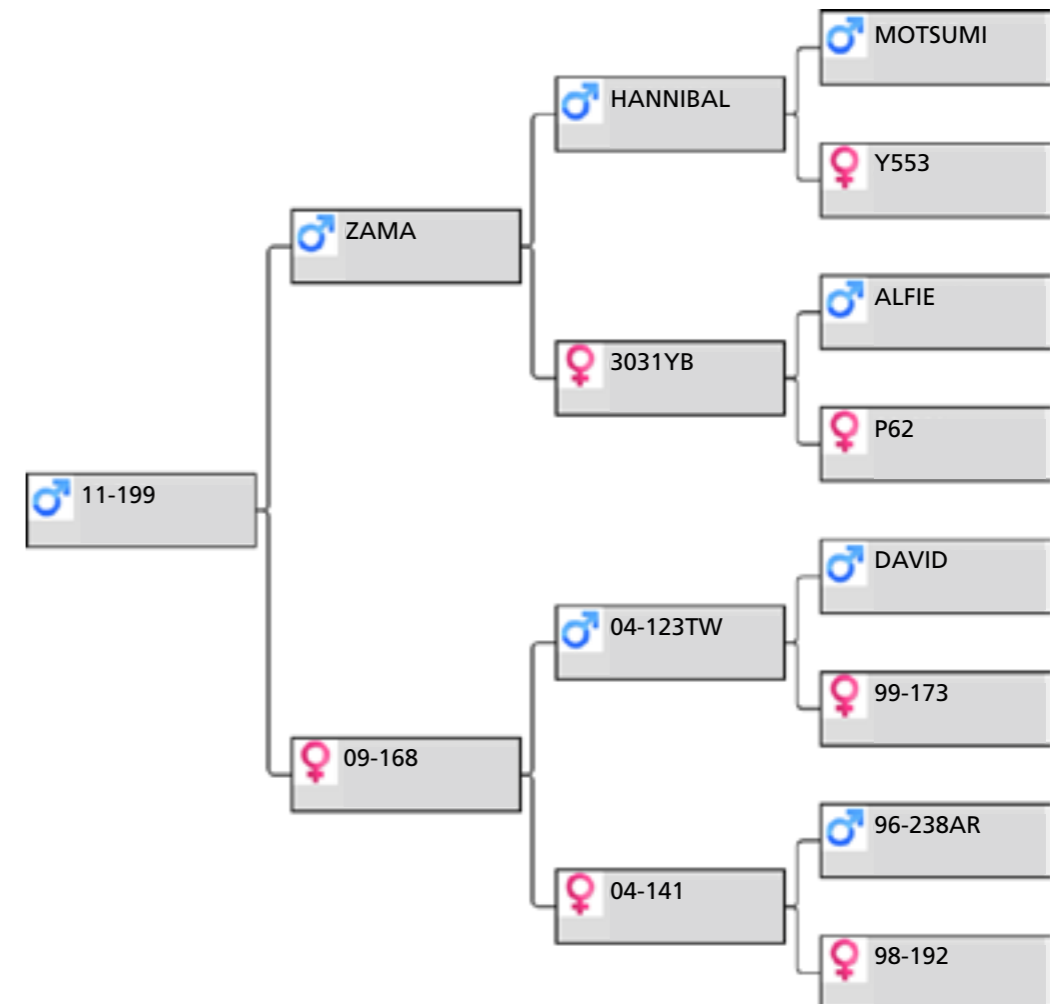

### Biography:

The second heaviest stag when weighed on 15th December at 242kg, and out of a first fawner. A heavy head of velvet too at 7.65kg, sired by Zama 12.25kg.  
123-04 502 IOA at 4yr and leaving good velvet. 141-04 dam of lot #1 2014 229-10 sold to Lindsey Tayles for \$20,000. More proven genetics that should breed on.  
3yr weight 15/12/14 242kg.

Sale weight: Price: Buyer:



## lot # 12 – 3yr sire stag



Animal: **11-067**

Birthdate: 2011

Weigh Date	Weight
2/04/2012	65 kg
31/01/2013	136 kg
20/01/2014	173 kg

Velvet Date	Weight	Grade
1/11/2014	6.90	
1/12/2013	5.10	

3yr Velvet weight: 6.90kg

### Pedigree:

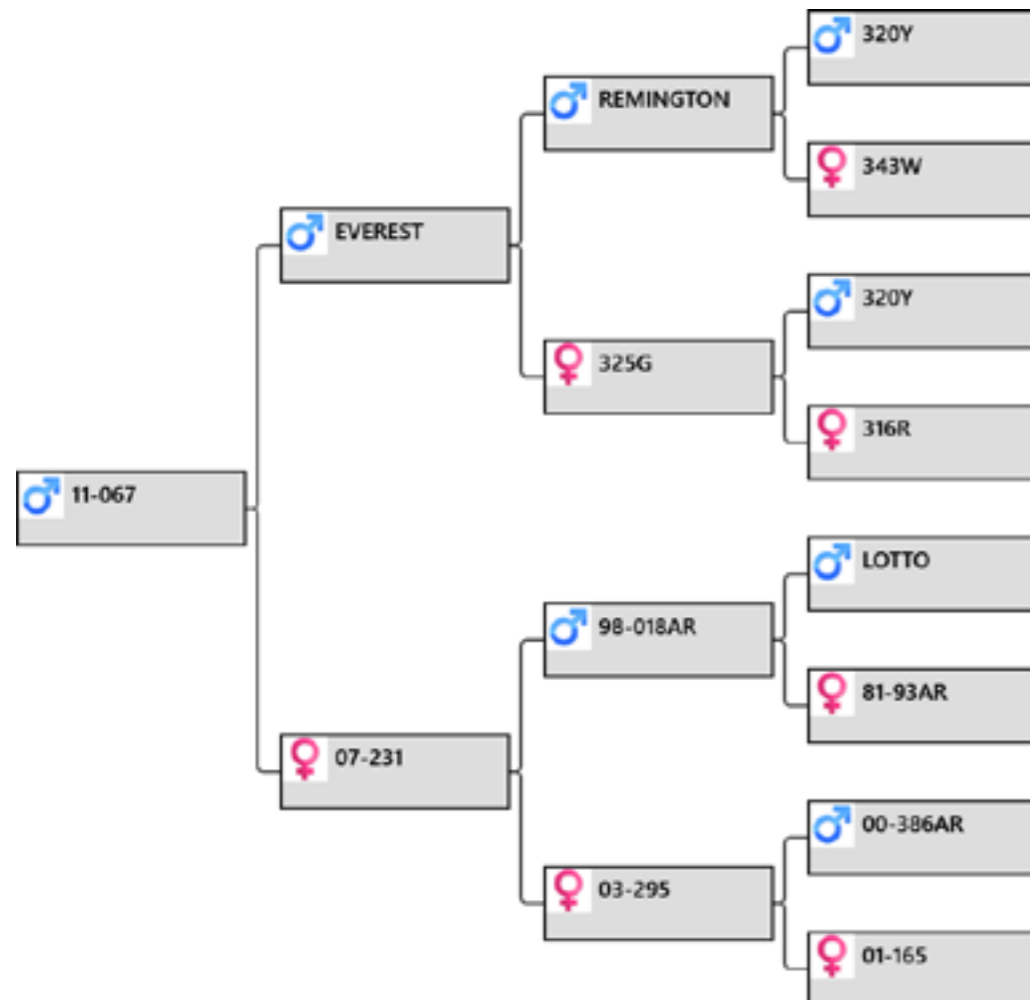

### Biography:

By Everest 12.25kg SA. Sire of 2 national velvet champions bred at Altrive. Grand dam 295-03 dam of 167-11 6.5kg 3yr also in sale, her sire 386-00 15.5kg SS velvet. 165-01 dam of stag cutting 12.1kg SS velvet 2014  
3yr weight 15/12/14 212kg

Sale weight: Price: Buyer:

## lot # 13 – 3yr sire stag



Animal: **11-106**

Birthdate: 2011

Weigh Date	Weight
2/04/2012	78 kg
31/01/2013	140 kg
20/01/2014	182 kg

Velvet Date	Weight	Grade
1/11/2014	7.15	
1/12/2013	4.70	

3yr Velvet weight: 7.15kg

### Pedigree:

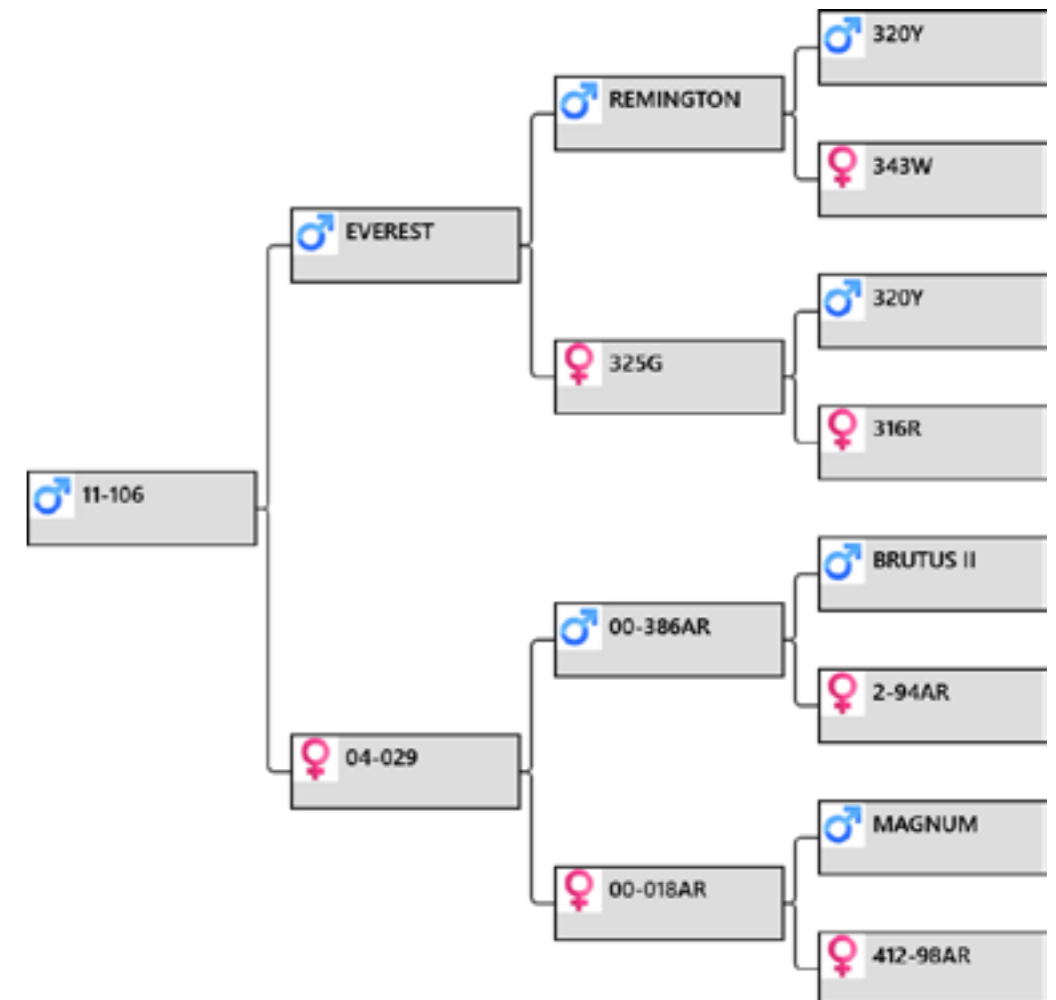

### Biography:

Another Everest son out of a top hind 29-04 who has had 3 sons cutting 4.7 5.2 and 4.1kg @ 2yr. AR 386-00 15.5kg SS velvet  
3yr weight 15/12/14 225kg

Sale weight: Price: Buyer:

## lot # 14 – 3yr sire stag



Animal: **11-255**

Birthdate: 2011

Weigh Date	Weight
2/04/2012	67 kg
31/01/2013	123 kg
20/01/2014	176 kg

Velvet Date	Weight	Grade
1/12/2014	5.60	
1/12/2013	3.90	

3yr Velvet weight: 5.60kg

### Pedigree:

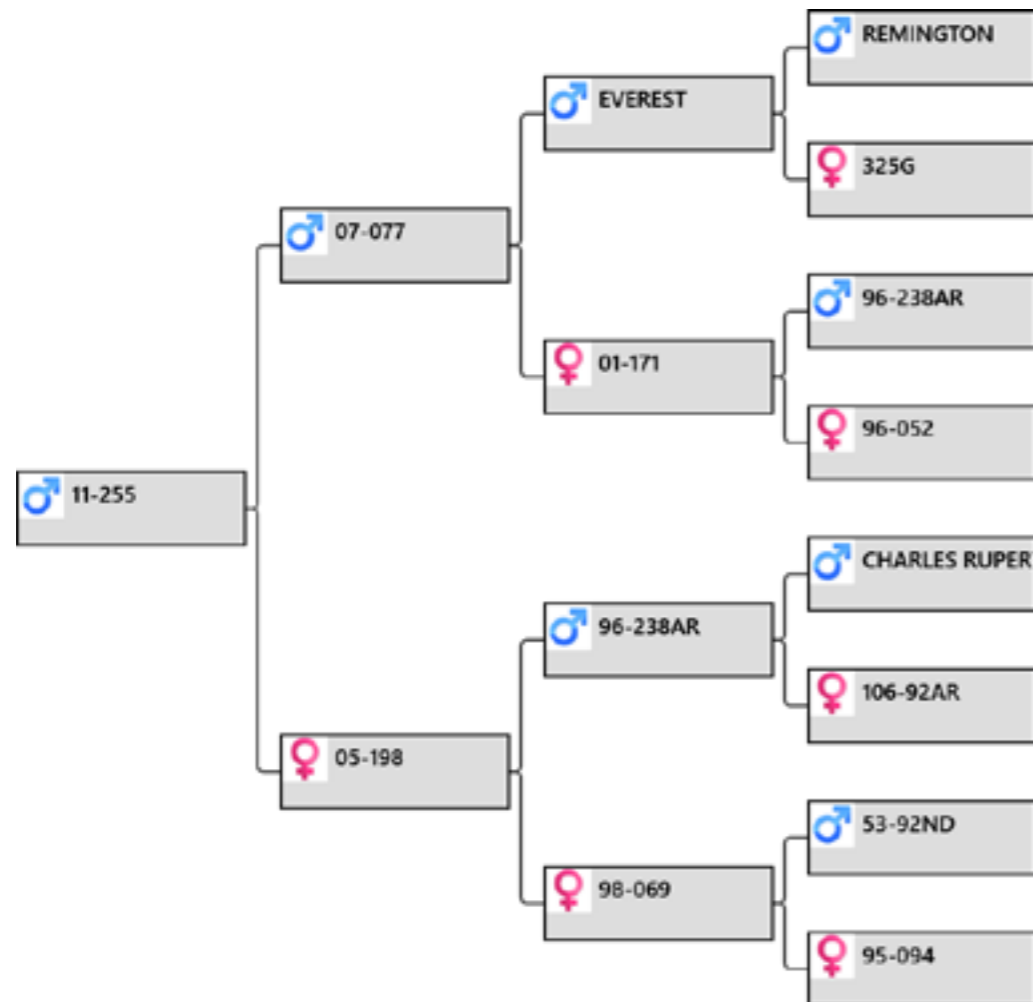

### Biography:

255-11 by 77-07 10kg SA 6yr. 2nd place at nationals as 4yr old. 77-07 has left some good 2yr olds this year as we are doing the catalogue with the heaviest 5.45kg. 3yr weight 15/12/14 212kg

Sale weight: Price: Buyer:

## lot # 15 – 3yr sire stag



Animal: **11-117**

Birthdate: 2011

Weigh Date	Weight
2/04/2012	63 kg
31/01/2013	122 kg
20/01/2014	174 kg

Velvet Date	Weight	Grade
1/11/2014	5.60	
1/12/2013	3.70	

3yr Velvet weight: 5.60kg

### Pedigree:

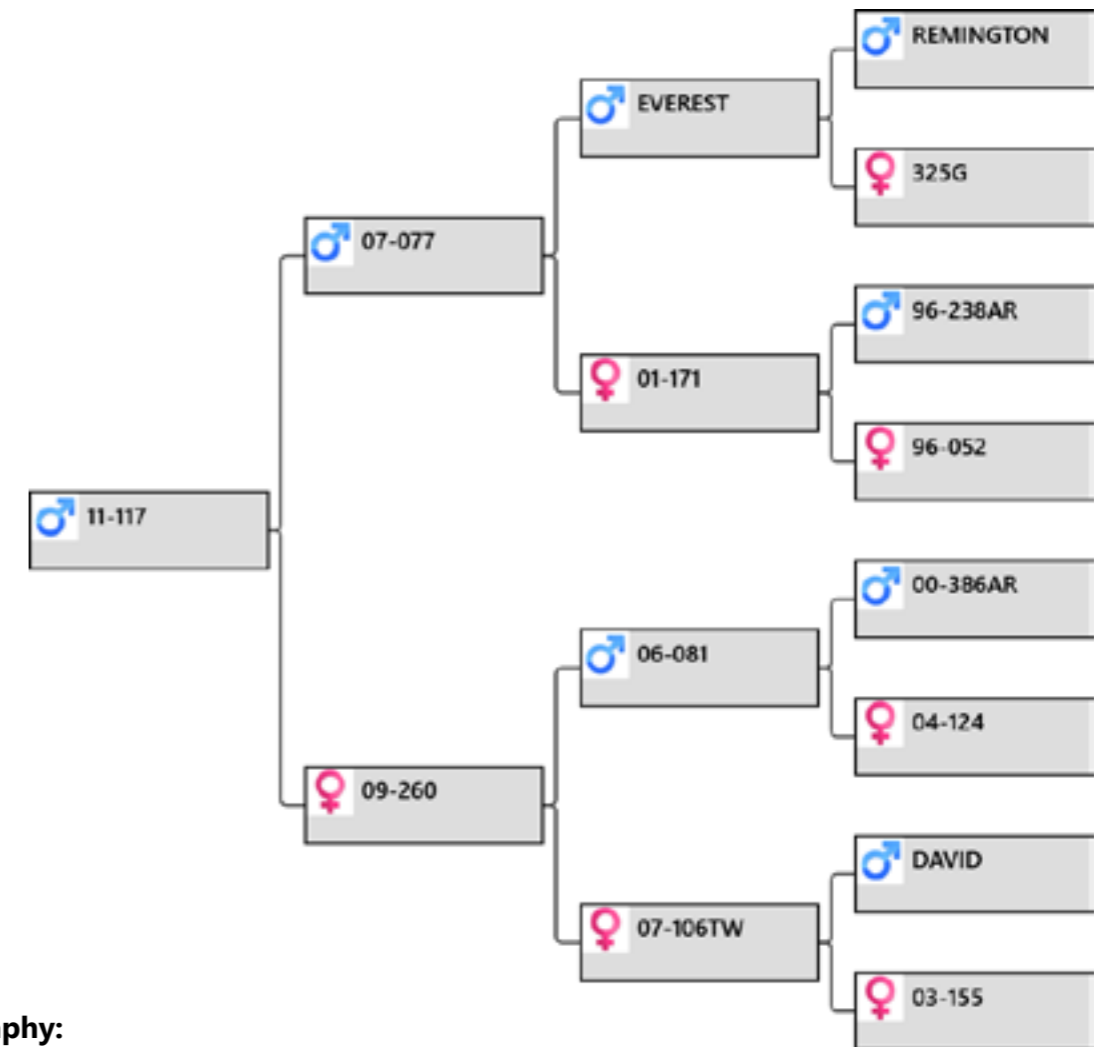

### Biography:

Another son of 77-07 out of first fawner 260-09 who had a daughter sold last year for \$2100. A very strong velvet pedigree with 155-03 a very good hind with a son sold 2013 and 2014 sales. The dam of 155-03 46-95 had 8 daughters and 3 very good sons with 2 used in the stud and the 3 of them sold as good trophy stags up to 485 SCI. Her dam 67-92 a son used in stud and her dam 9-90 2 sons used in stud. 3yr weight 15/12/14 221kg

Sale weight: Price: Buyer:

## lot # 16 – 3yr sire stag



Animal: **11-004**

Birthdate: 2011

Weigh Date	Weight
2/04/2012	68 kg
31/01/2013	130 kg
20/01/2014	187 kg

Velvet Date	Weight	Grade
1/11/2014	5.40	
1/12/2013	3.90	

3yr Velvet weight: 5.40kg

### Pedigree:

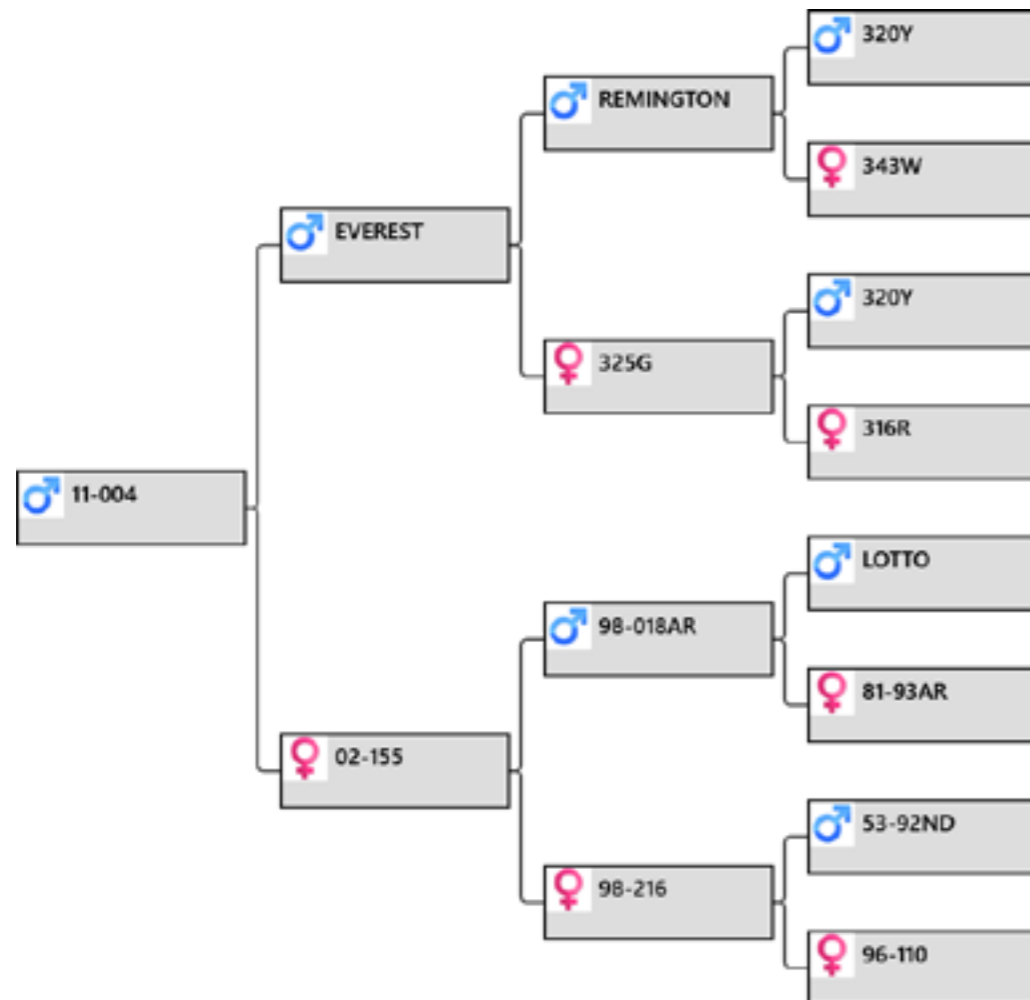

### Biography:

4-11 228kg mid December and very tidy velvet on this Everest son. 155-02 2yr son 153-12 just cut a nice 4.3kg head as catalogue going to print. 216-98 dam of very good trophy stag. 3yr weight 15/12/14 228kg

Sale weight: Price: Buyer:

## lot # 17 – 3yr sire stag



Animal: **11-065**

Birthdate: 2011

Weigh Date	Weight
2/04/2012	72 kg
31/01/2013	134 kg
20/01/2014	162 kg

Velvet Date	Weight	Grade
1/11/2014	6.30	
1/12/2013	4.80	

3yr Velvet weight: 6.30kg

### Pedigree:

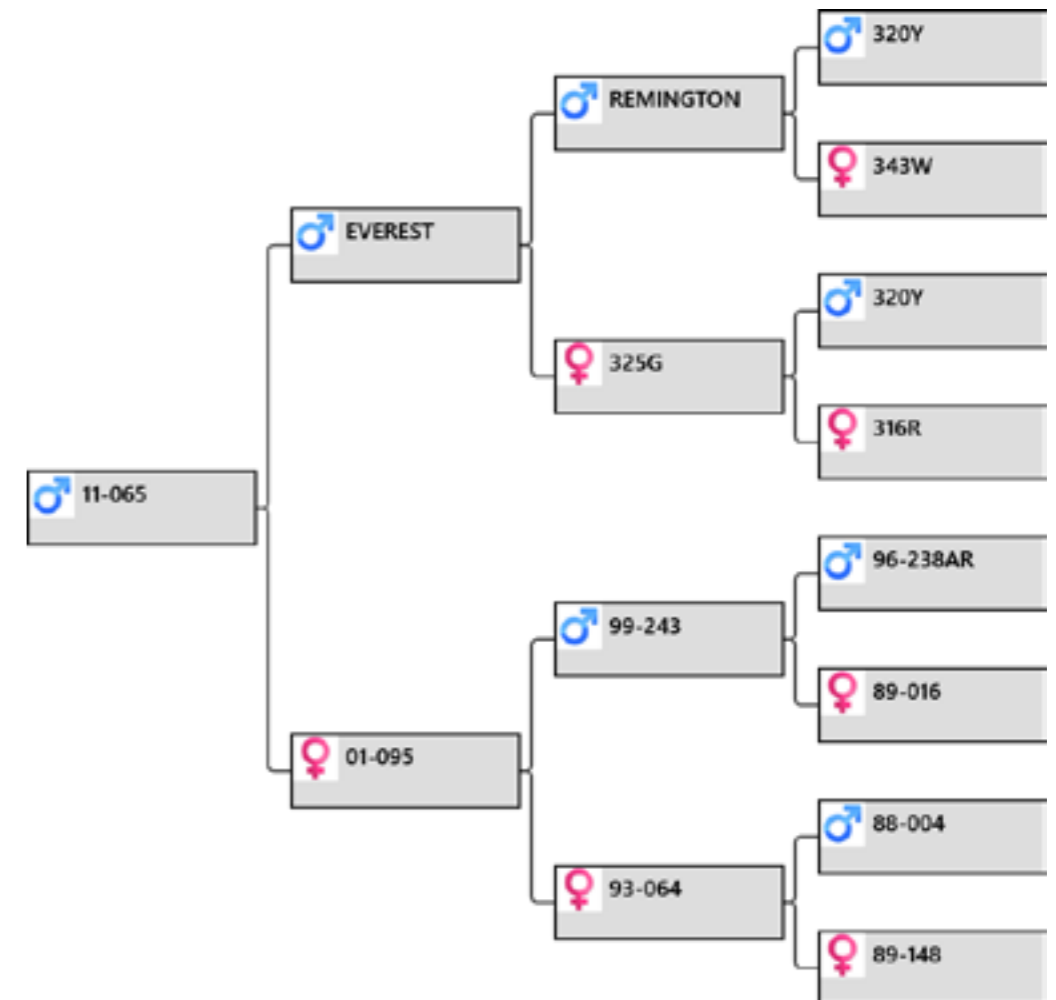

### Biography:

65-11 by Everest 12.25kg SA out of older but proven hind 95-01. Her 4 sons cut 3.75kg, 3.8kg, 4.0kg, and 4.8kg @ 2yr 3yr weight 15/12/14 194kg

Sale weight: Price: Buyer:



## lot # 18 – 3yr sire stag



Animal: **11-242**

Birthdate: 2011

Weigh Date	Weight
2/04/2012	62 kg
31/01/2013	117 kg
20/01/2014	161 kg

Velvet Date	Weight	Grade
1/11/2014	6.70	
1/12/2013	4.85	

3yr Velvet weight: 6.70kg

### Pedigree:

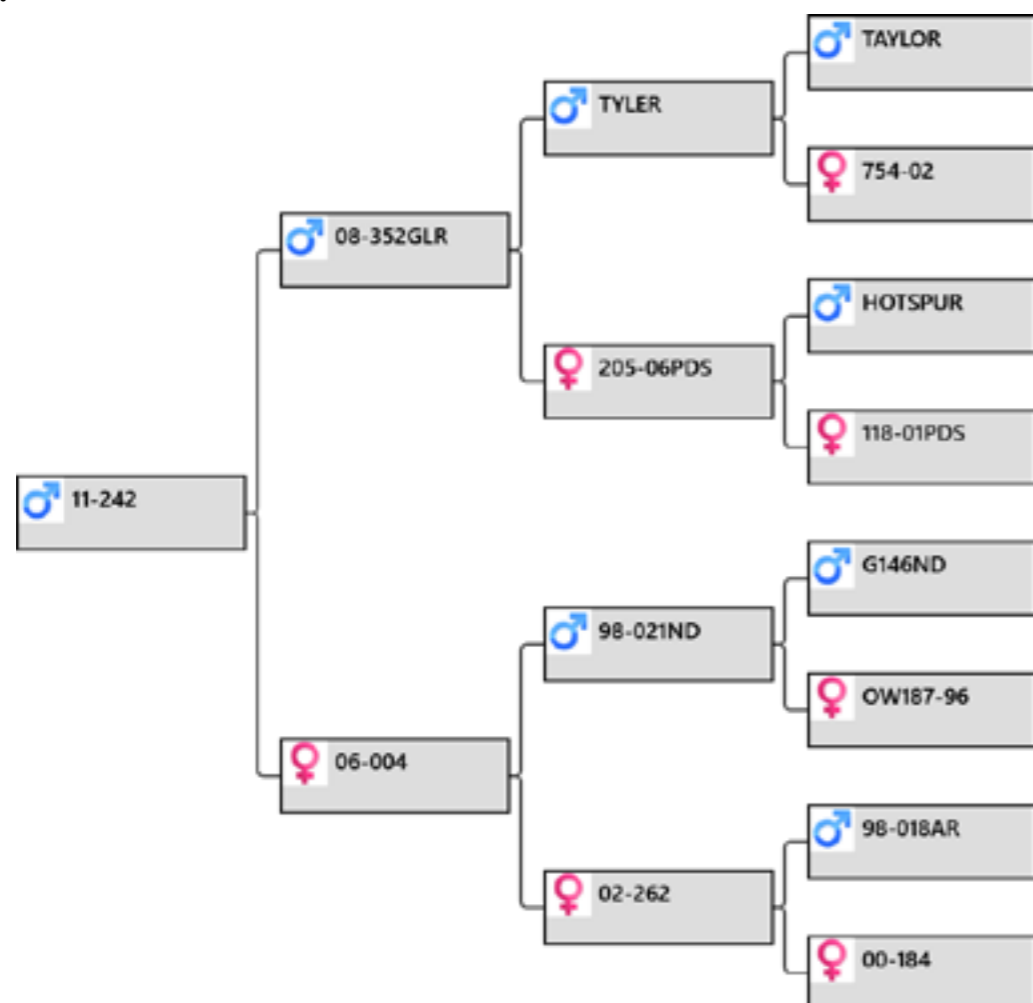

### Biography:

242-11 by GLR 352-08 9.75kg SA 5yr out of top hind 4-06 who had a son sold 2014 sale. 184-00 a son sold 2013 \$9500 and 2014 \$6500. Her dam 4-98 has 3 sons sold as trophy stags. 3yr weight 15/12/14 206kg.

Sale weight: \_\_\_\_\_ Price: \_\_\_\_\_ Buyer: \_\_\_\_\_

## lot # 19 – 3yr sire stag



Animal: **11-187**

Birthdate: 2011

Weigh Date	Weight
2/04/2012	61 kg
31/01/2013	127 kg
20/01/2014	192 kg

Velvet Date	Weight	Grade
1/11/2014	5.65	
1/12/2013	4.50	

3yr Velvet weight: 5.65kg

### Pedigree:

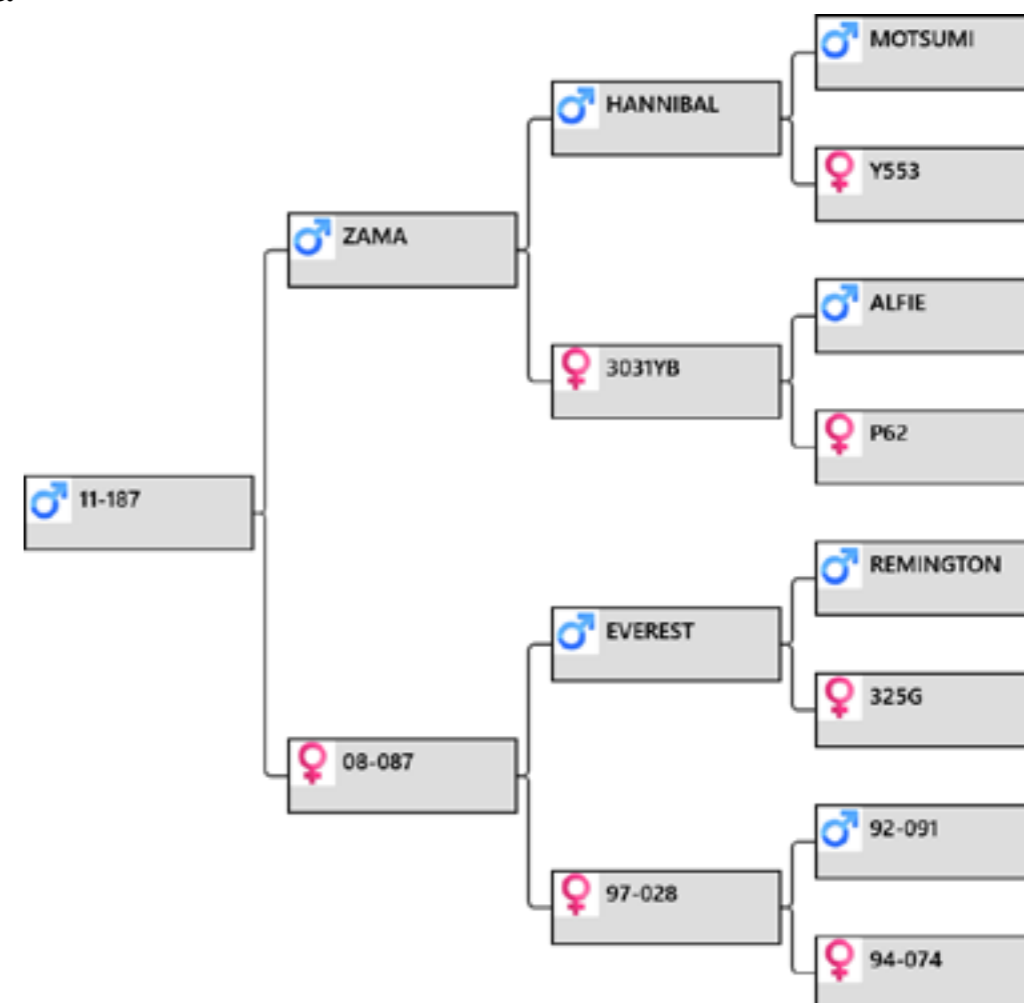

### Biography:

231kg mid December with nice correct velvet by Zama 12.25kg SA out of 87-08 who has only had one son. 28-97 had a son sold as sire and 74-94 is the dam of top hind 122-98 who features in lot one and lot three. 3yr weight 15/12/14 231kg

Sale weight: \_\_\_\_\_ Price: \_\_\_\_\_ Buyer: \_\_\_\_\_

## lot # 20 – 3yr sire stag



Animal: **11-159**

Birthdate: 2011

Weigh Date	Weight
2/04/2012	69 kg
31/01/2013	125 kg
20/01/2014	184 kg

Velvet Date	Weight	Grade
1/11/2014	6.35	
1/12/2013	4.05	

3yr Velvet weight: 6.35kg

### Pedigree:

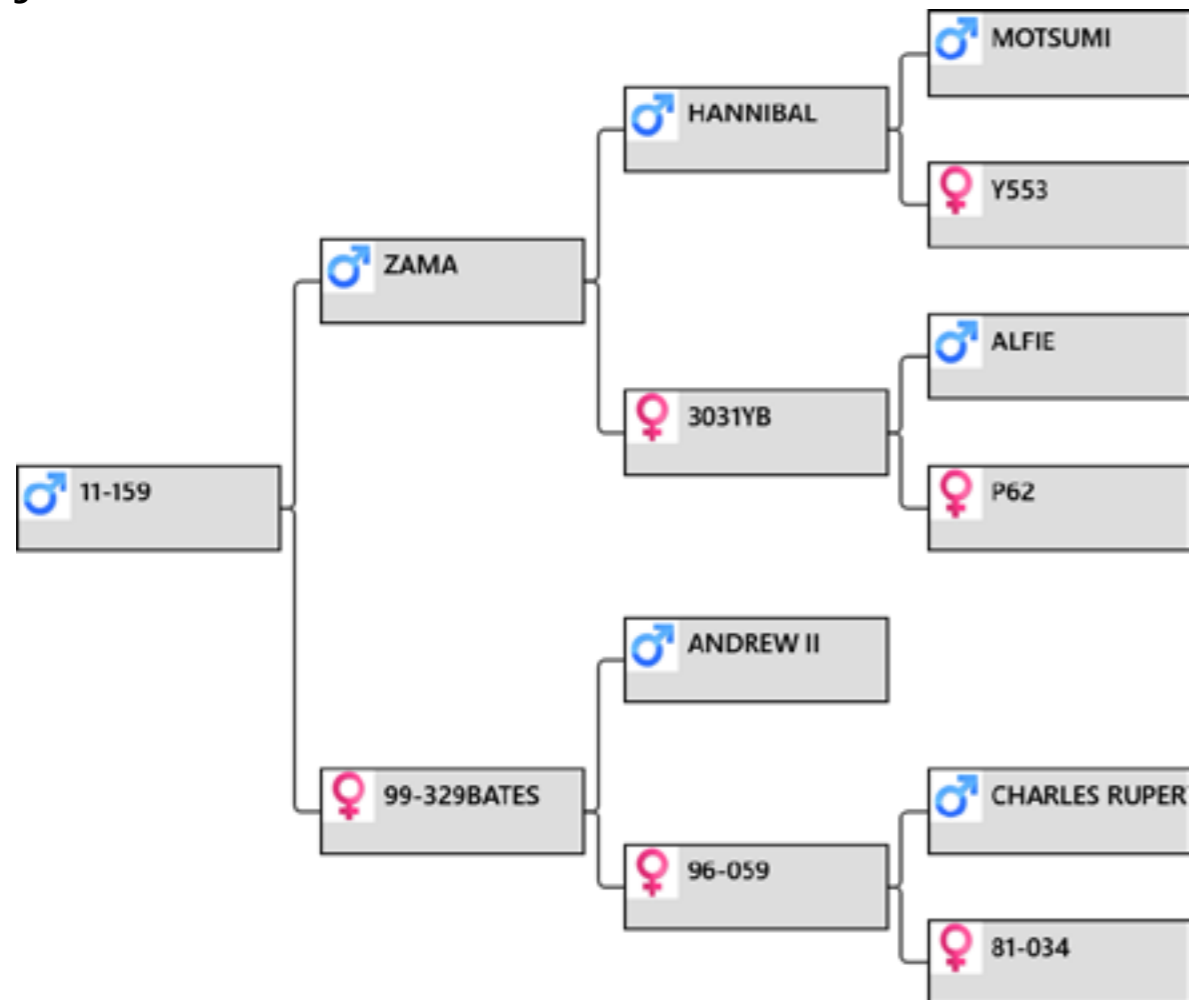

### Biography:

Good body weight and tidy velvet on this Zama son. 329-99 has a son in the velvet mob who cut 7.05 @5yr. 59-96 is the dam of David 11kg SA and 34-81 dam of Lancelot and Andrew II. 3yr weight 15/12/14 229kg

Sale weight: Price: Buyer:

## lot # 21 – 3yr sire stag



Animal: **11-084**

Birthdate: 2011

Weigh Date	Weight
2/04/2012	73 kg
31/01/2013	129 kg
20/01/2014	168 kg

Velvet Date	Weight	Grade
1/12/2014	5.60	
1/12/2013	3.95	

3yr Velvet weight: 5.6kg

### Pedigree:

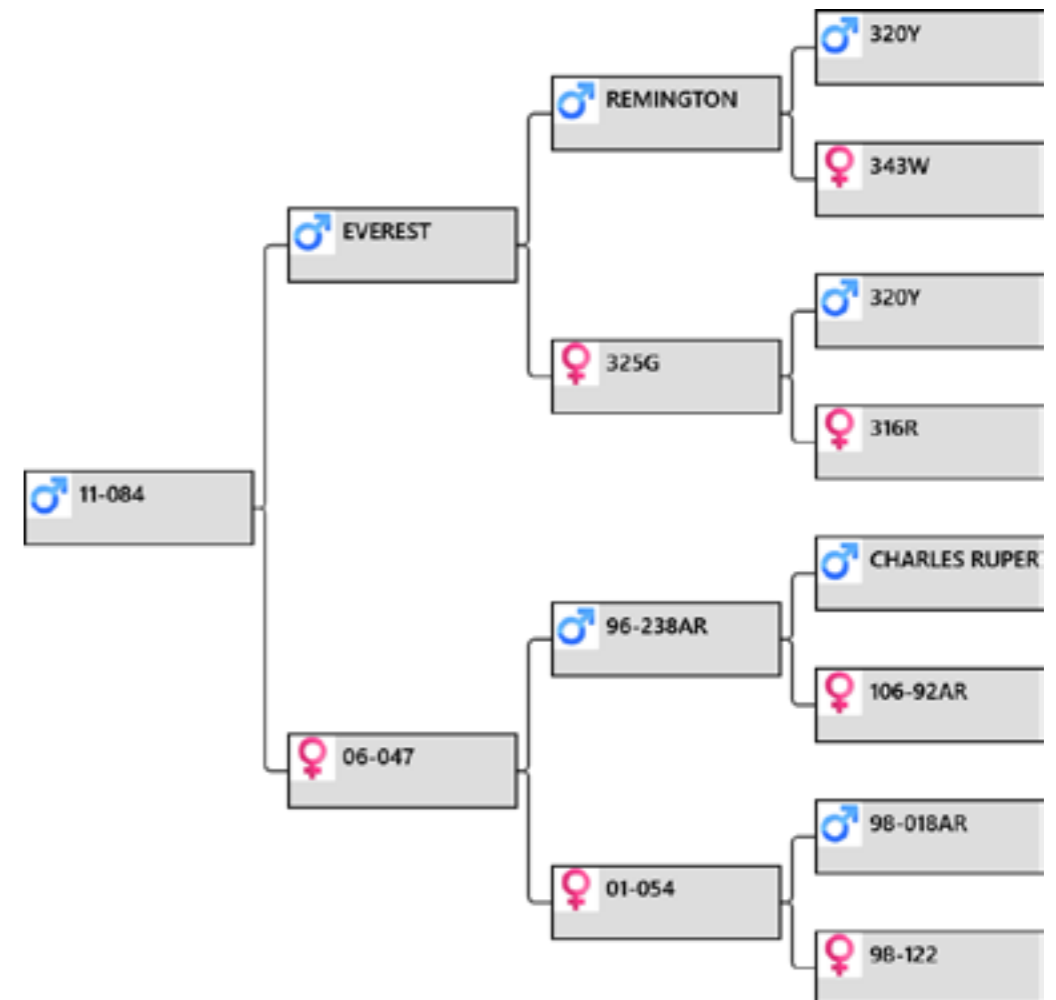

### Biography:

Everest son out of 47-06. Just cut a 2yr old full brother to 84-11 122-12 4.4kg. 54-01 is in lot #1 and three pedigrees also. She has had 3 sons sold at auction and 122-98 is in lot #1 and three pedigrees as well with a son sold lot 10 2013 \$8800. A lot of top animals go back to 122-98. 3yr weight 15/12/14 204kg.

Sale weight: Price: Buyer:

## lot # 22 – 3yr sire stag



Animal: **11-209**

Birthdate: 2011

Weigh Date	Weight
2/04/2012	57 kg
31/01/2013	137 kg
20/01/2014	187 kg

Velvet Date	Weight	Grade
1/11/2014	7.35	
1/12/2013	4.90	

3yr Velvet weight: 7.35kg

### Pedigree:

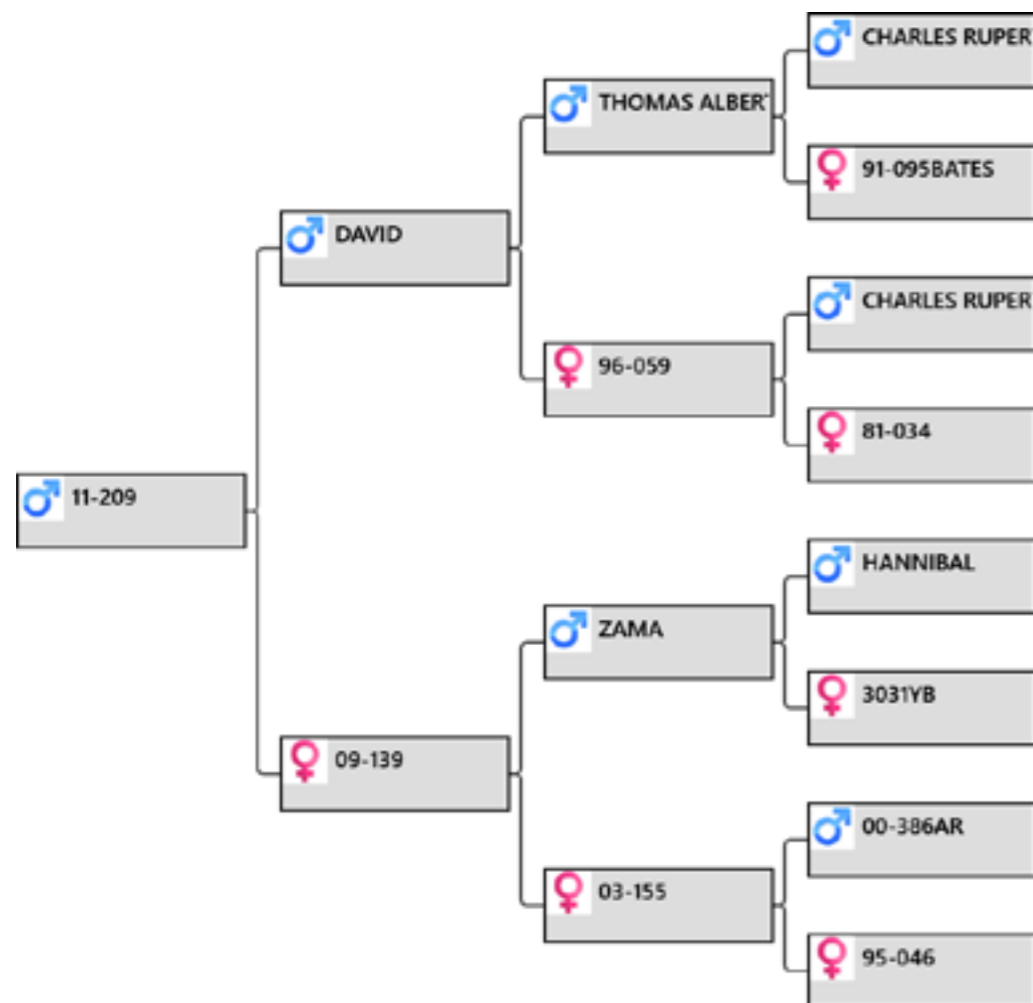

### Biography:

3rd heaviest stag mid December and out of first fawner. Heavy velvet too. David 11kg SA over Zama 12.25kg SA. 155-03 in this pedigree as well. Sons sold 2013 and 2014 sales and 46-95 two sons used in stud and her 3 sons sold as trophy stags up to 485 SCI.

3yr weight 15/12/14 241kg

Sale weight:

Price:

Buyer:

## lot # 23 – 3yr sire stag



Animal: **11-173**

Birthdate: 2011

Weigh Date	Weight
2/04/2012	68 kg
31/01/2013	151 kg
20/01/2014	198 kg

Velvet Date	Weight	Grade
1/11/2014	6.00	
1/12/2013	5.45	

3yr Velvet weight: 6.0kg

### Pedigree:

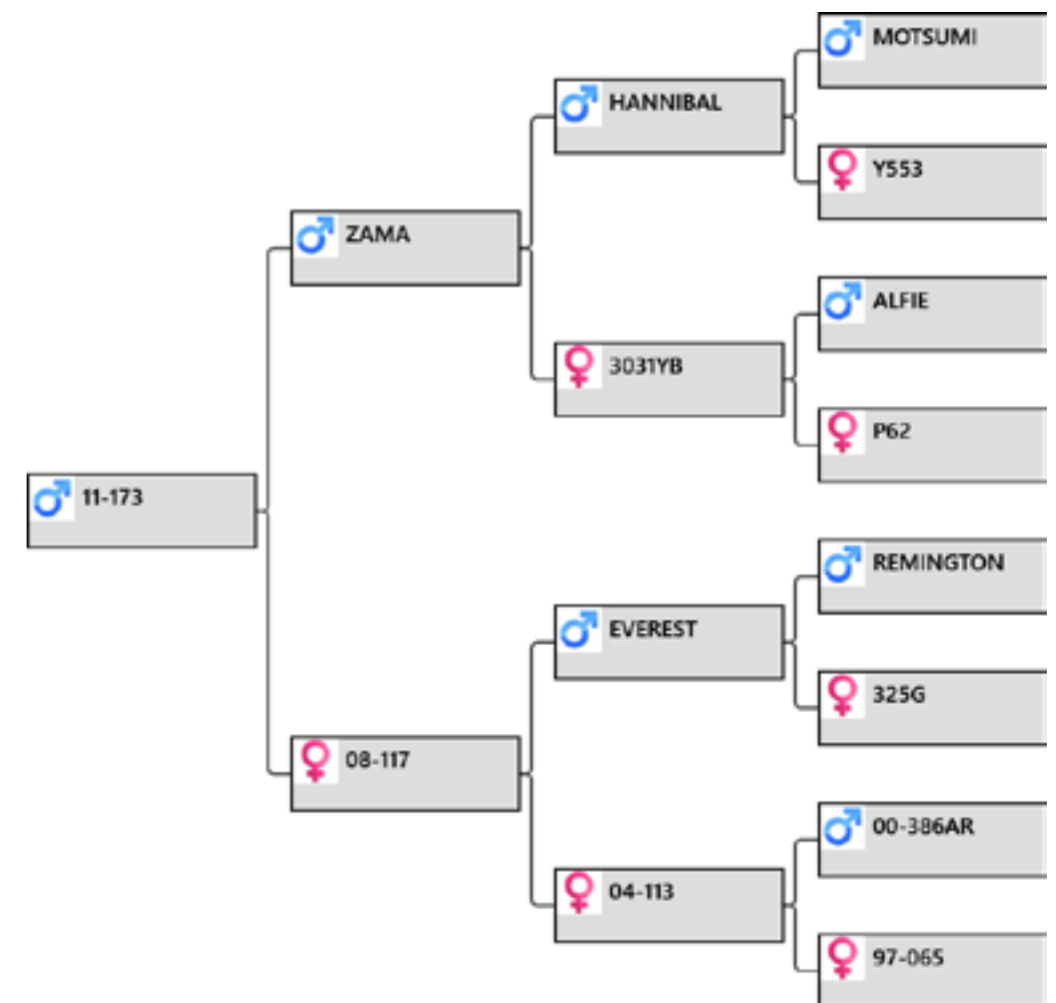

### Biography:

The heaviest stag at December weighing 245kg. Zama 12.25kg over Everest 12.25kg. 173-11 has full brother 71-12 cutting 4kg this year. 65-97 older but proven genetics with her best 2yr old cutting 4.65kg.

3yr weight 15/12/14 245kg

Sale weight:

Price:

Buyer:



## lot # 24 – 3yr sire stag



Animal: **11-167**

Birthdate: 2011

Weigh Date	Weight
2/04/2012	66 kg
31/01/2013	129 kg
20/01/2014	199 kg

Velvet Date	Weight	Grade
1/11/2014	6.50	
1/12/2013	5.15	

3yr Velvet weight: 6.5kg

### Pedigree:

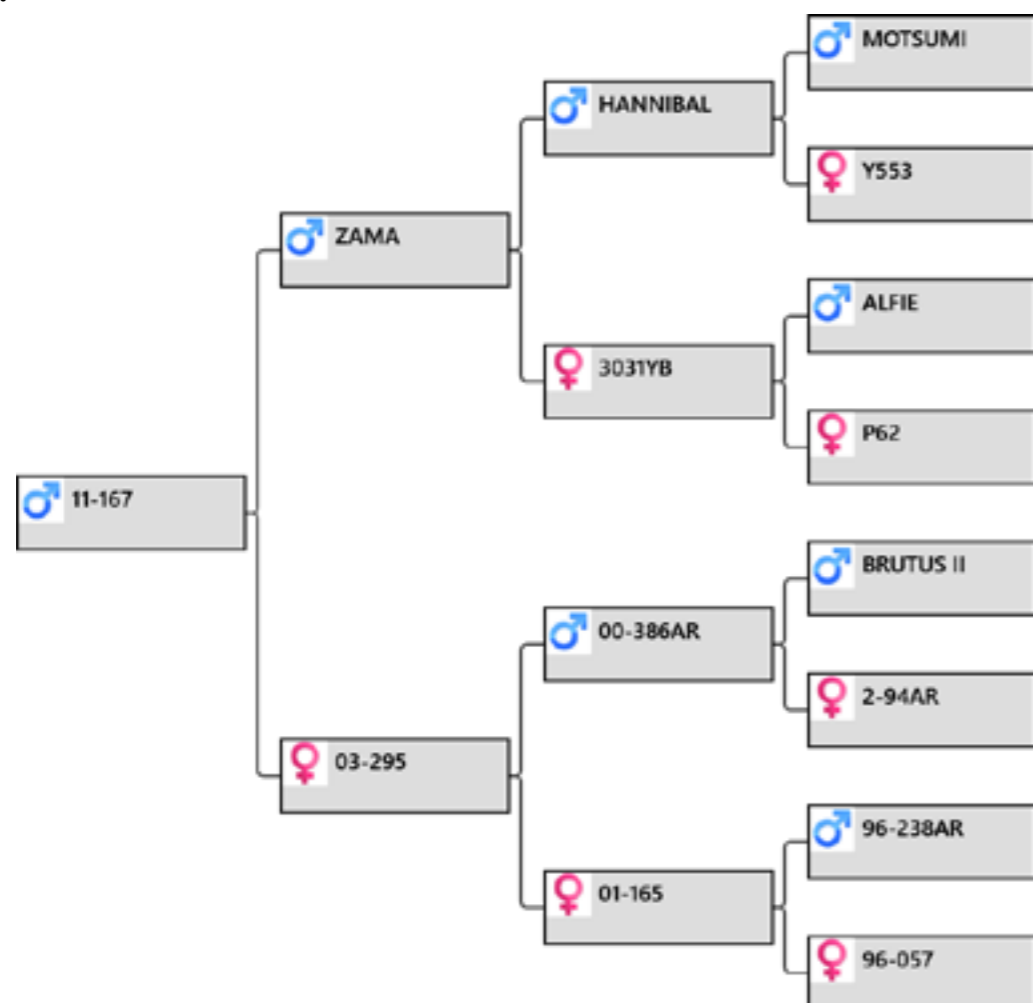

### Biography:

Heavy stag by Zama.  
3yr weight 15/12/14 238kg

Sale weight: Price: Buyer:

## lot # 25 – Yearling hind



performance recorded since 1985

Yearling Hind sale 2015

Animal: **13-005**

Birthdate: 2013

Weigh Date	Weight
30/03/2014	62 kg
30/11/2014	83 kg

### Pedigree:

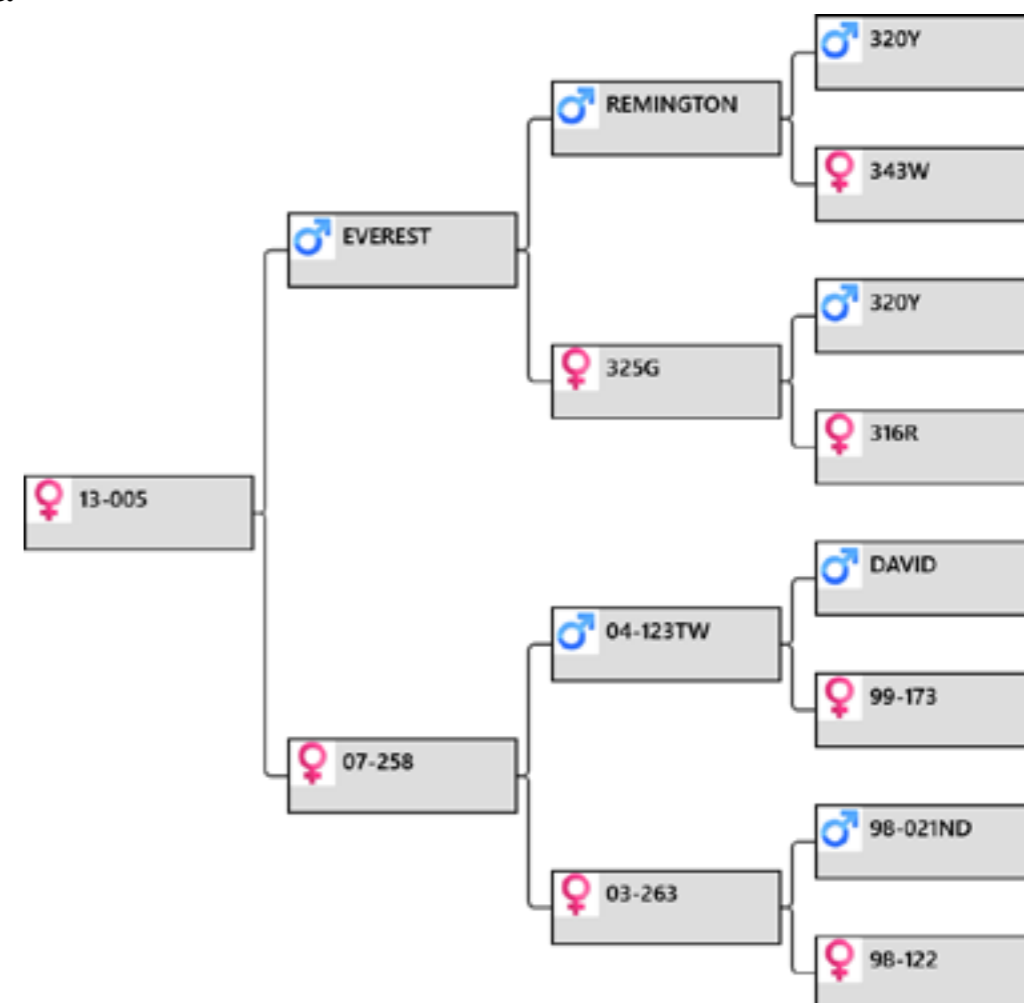

### Biography:

good Everest daughter going back to top hind 122-98 grand dam of Altrive 53-07 national 2YR velvet champion and dam of 2 sons sold as sires

Sale weight: Price: Buyer:

## lot # 26 – Yearling hind



performance recorded since 1985

Yearling Hind sale 2015

Animal: **13-009**

Birthdate: 2013

Weigh Date	Weight
30/03/2014	60 kg
30/11/2014	83 kg

### Pedigree:

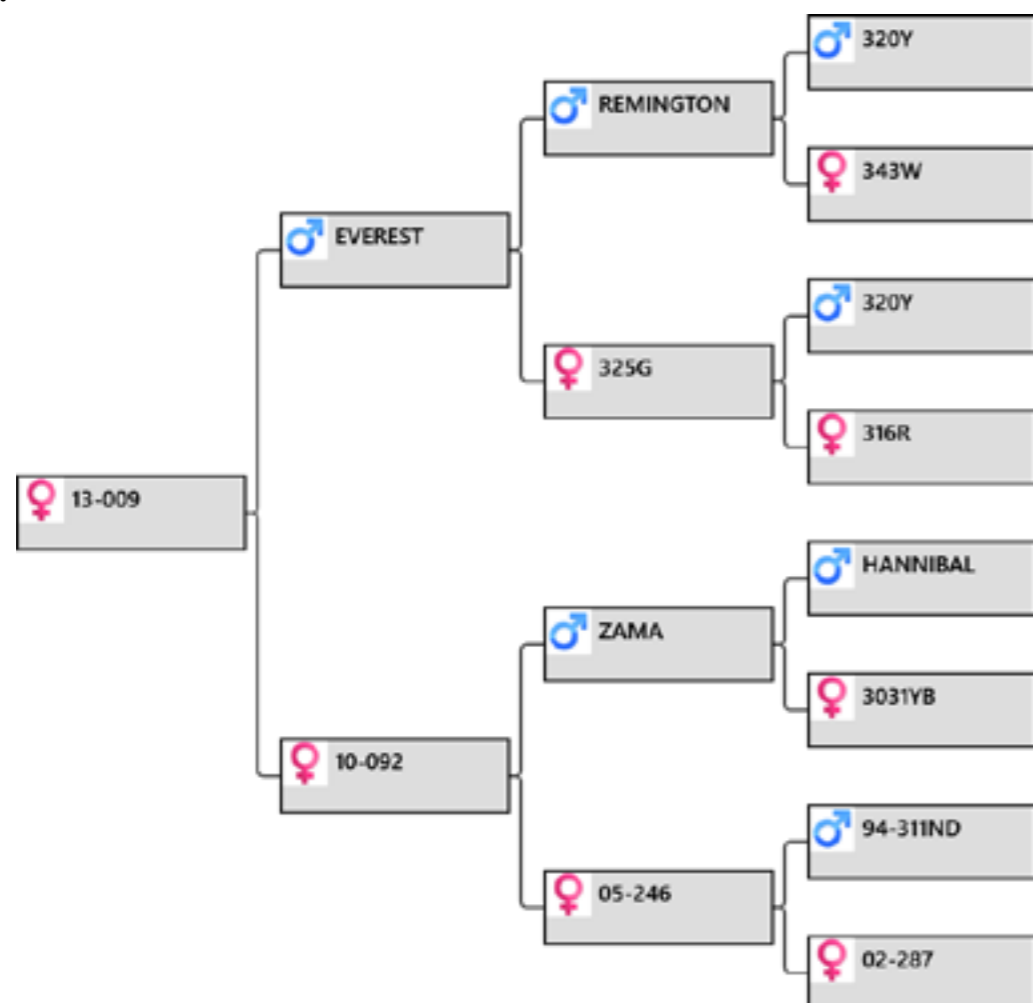

### Biography:

Everest sire of 2 Altrive national velvet champions over Zama 2012 national champ and peoples choice

Sale weight: Price: Buyer:

## lot # 27 – Yearling hind



performance recorded since 1985

Yearling Hind sale 2015

Animal: **13-020**

Birthdate: 2013

Weigh Date	Weight
30/03/2014	57 kg
30/11/2014	89 kg

### Pedigree:

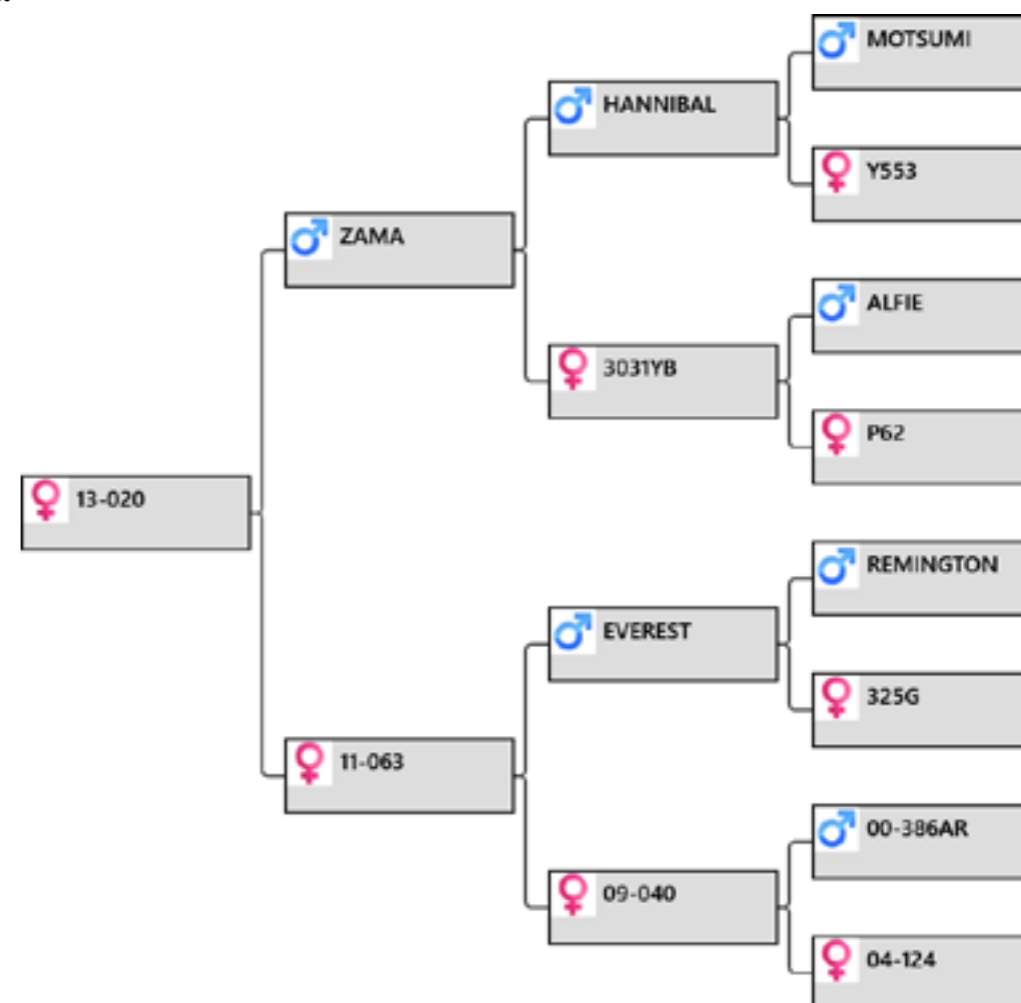

### Biography:

Special ET hind by Zama out of Everest daughter and her dam 40-09 is a full sister to Altrive 81-06 11.8 KG 7YR, he was national 4yr velvet champion.

Sale weight: Price: Buyer:

## lot # 28 – Yearling hind



Animal: **13-025**

Birthdate: 2013

Weigh Date	Weight
30/03/2014	60 kg
30/11/2014	86 kg

### Pedigree:

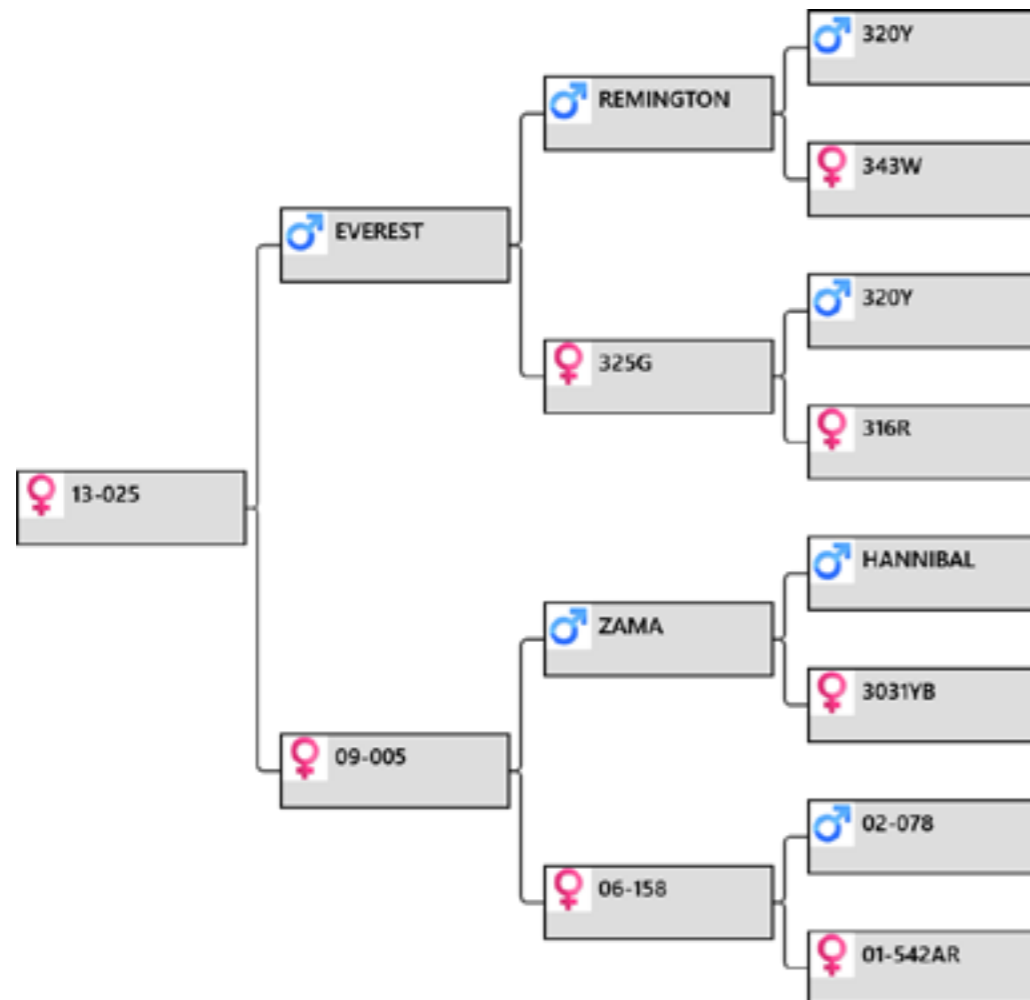

### Biography:

Everest 12.25 KG over Zama 12.25kg, has to be good.

Sale weight: Price: Buyer:

## lot # 29 – Yearling hind



Animal: **13-028**

Birthdate: 2013

Weigh Date	Weight
30/03/2014	64 kg
30/11/2014	92 kg

### Pedigree:

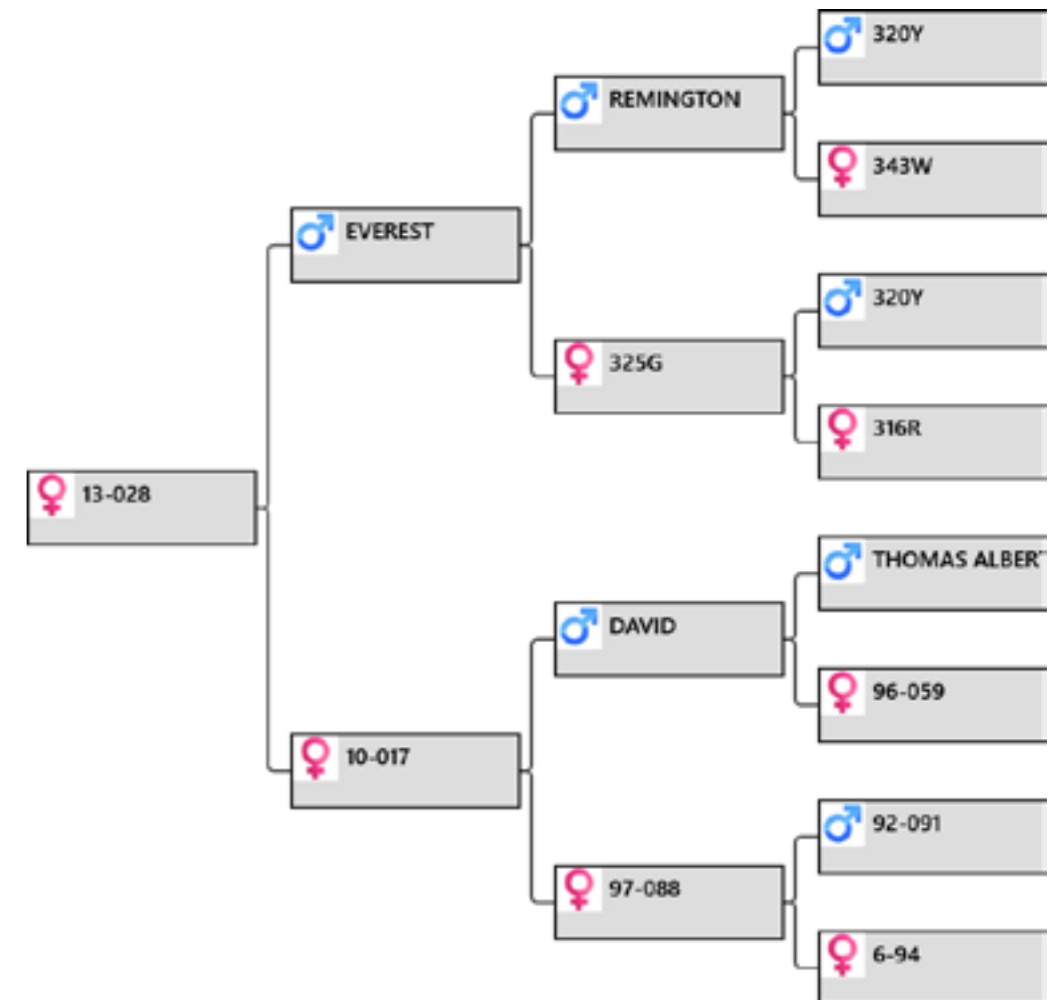

### Biography:

Everest over David 11KG SA

Sale weight: Price: Buyer:

## lot # 30 – Yearling hind



performance recorded since 1985

Yearling Hind sale 2015

Animal: **13-043**

Birthdate: 2013

Weigh Date	Weight
30/03/2014	60 kg
30/11/2014	80 kg

### Pedigree:

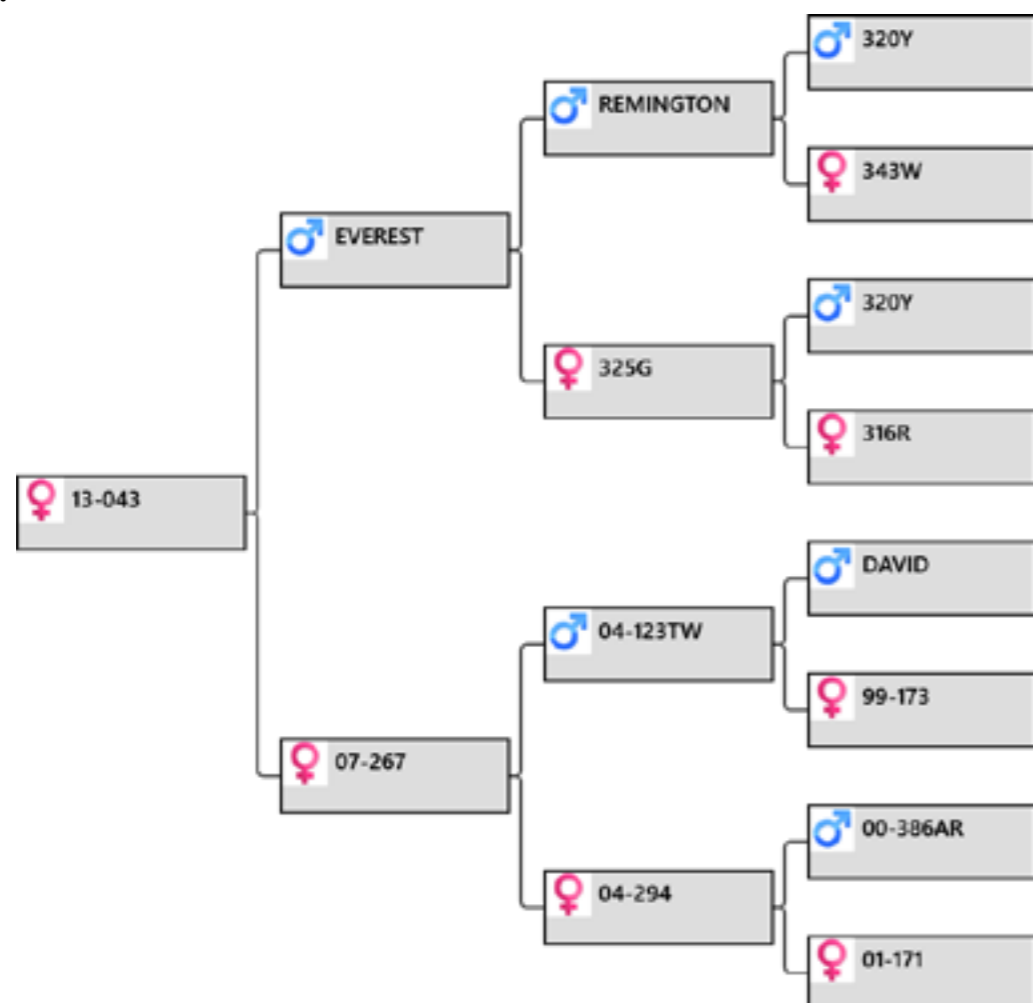

### Biography:

Everest daughter with bottom line going back to 171-01 dam of Altrive sire 77-07

Sale weight:

Price:

Buyer:

## lot # 31 – Yearling hind



performance recorded since 1985

Yearling Hind sale 2015

Animal: **13-044**

Birthdate: 2013

Weigh Date	Weight
30/03/2014	64 kg
30/11/2014	83 kg

### Pedigree:

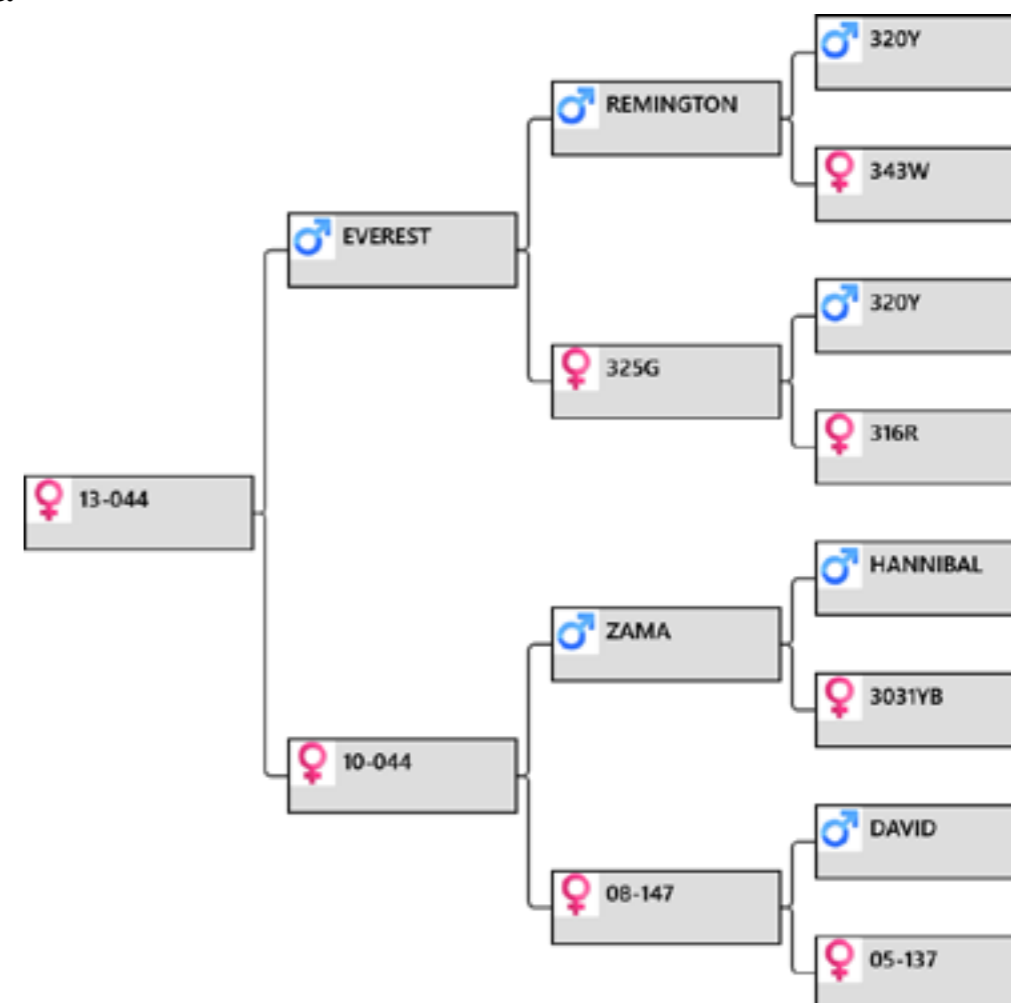

### Biography:

Very heavy velvet genetics, Everest 12.25 kg Zama 12.25 kg David 11kg and 137-05 dam of 6.85kg 2yr old sold to Alan Stewart

Sale weight:

Price:

Buyer:



## lot # 32 – Yearling hind



Animal: **13-048**

Birthdate: 2013

Weigh Date	Weight
30/03/2014	65 kg
30/11/2014	91 kg

### Pedigree:

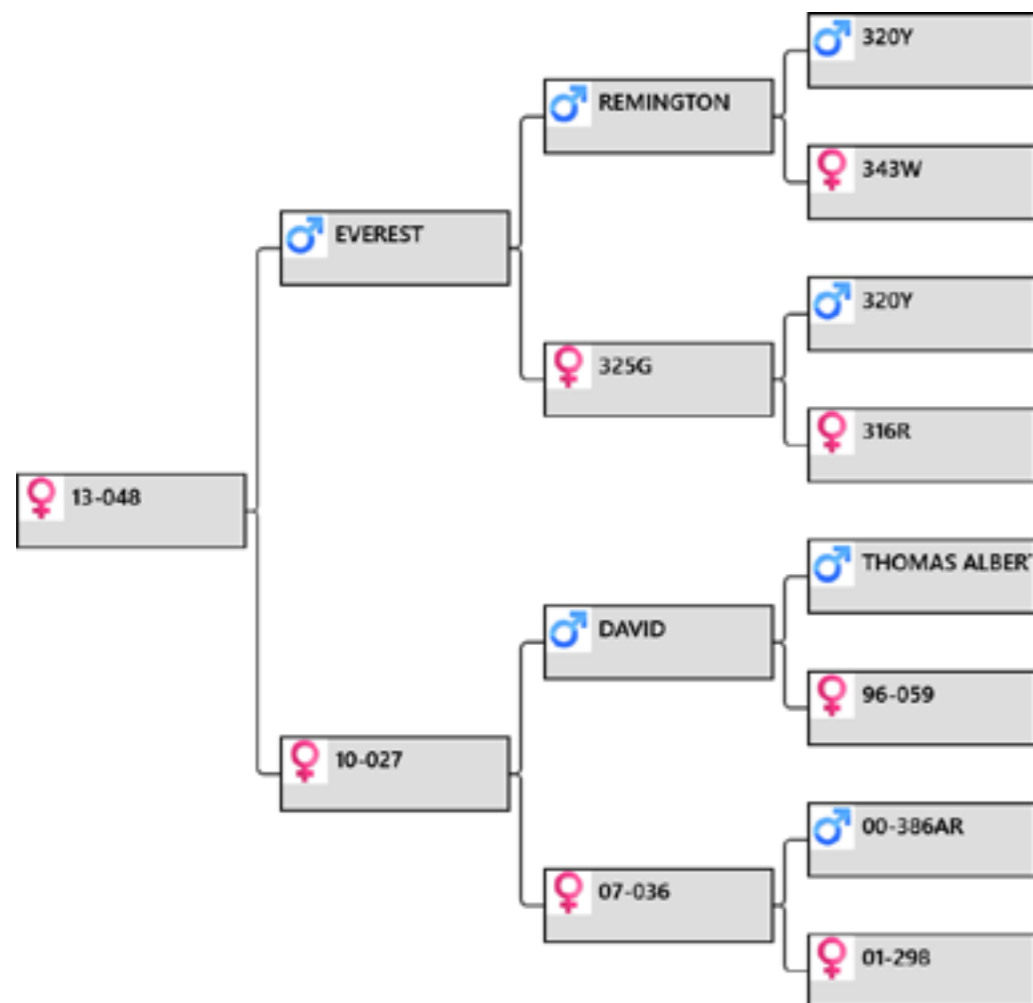

### Biography:

Good Everest Daughter back to top hind 298-01 dam of 2 sire stags sold for \$9000 and \$4800 plus good trophy stag

Sale weight: Price: Buyer:

## lot # 33 – Yearling hind



Animal: **13-065**

Birthdate: 2013

Weigh Date	Weight
30/03/2014	69 kg
30/11/2014	98 kg

### Pedigree:

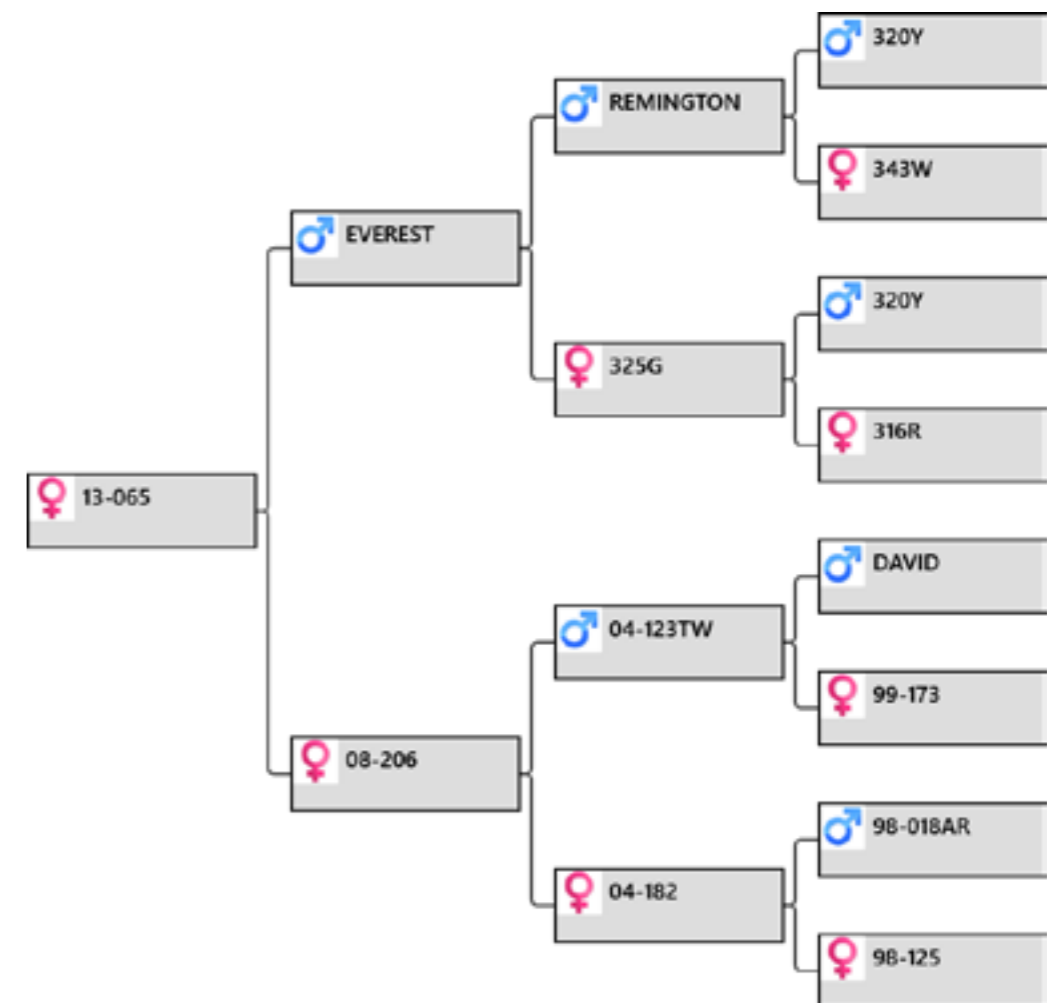

### Biography:

Everest daughter with good weaner weight 68.5kg 30/3/14

Sale weight: Price: Buyer:

## lot # 34 – Yearling hind



Animal: **13-068**

Birthdate: 2013

Weigh Date	Weight
30/03/2014	62 kg
30/11/2014	96 kg

### Pedigree:

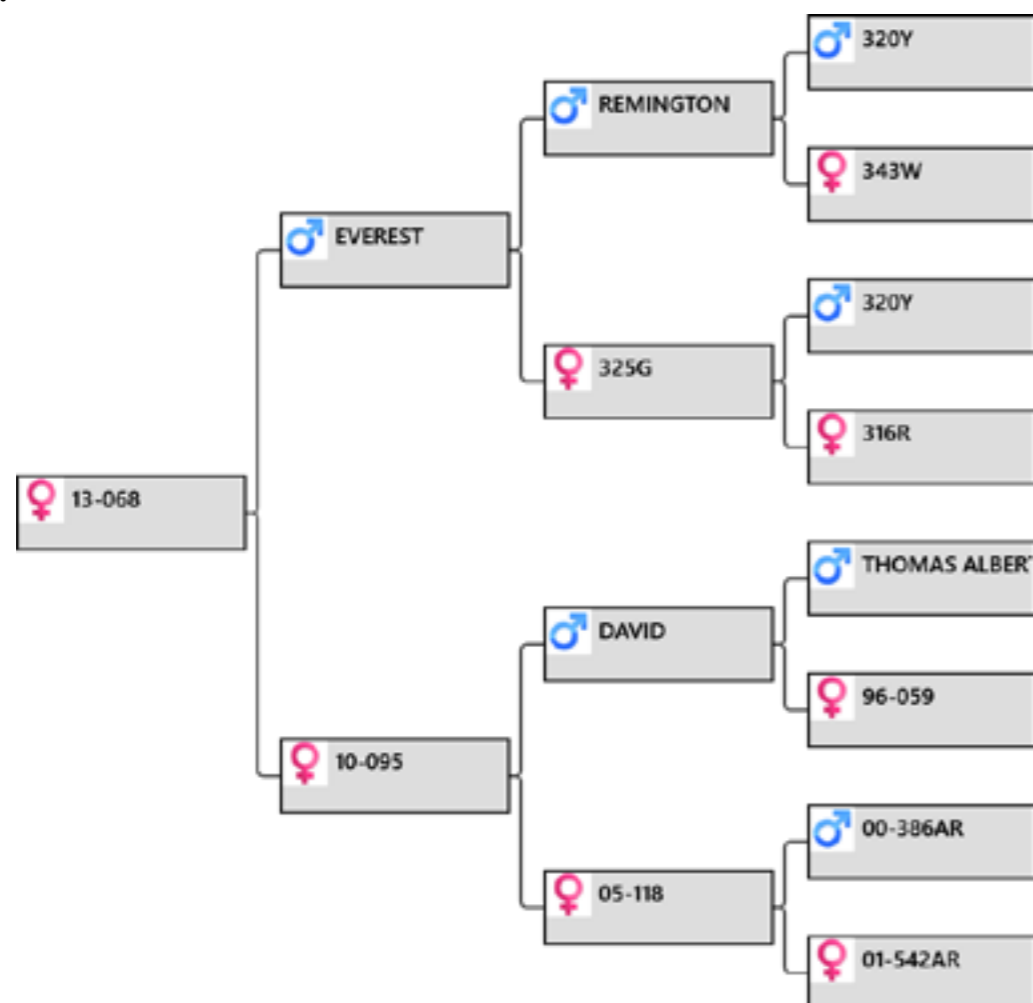

### Biography:

Still strong velvet genetics back to 386-00 sire of Altrive 81-06 11.8kg @7yr

Sale weight: Price: Buyer:

## lot # 35 – Yearling hind



Animal: **13-070**

Birthdate: 2013

Weigh Date	Weight
30/03/2014	67 kg
30/11/2014	85 kg

### Pedigree:

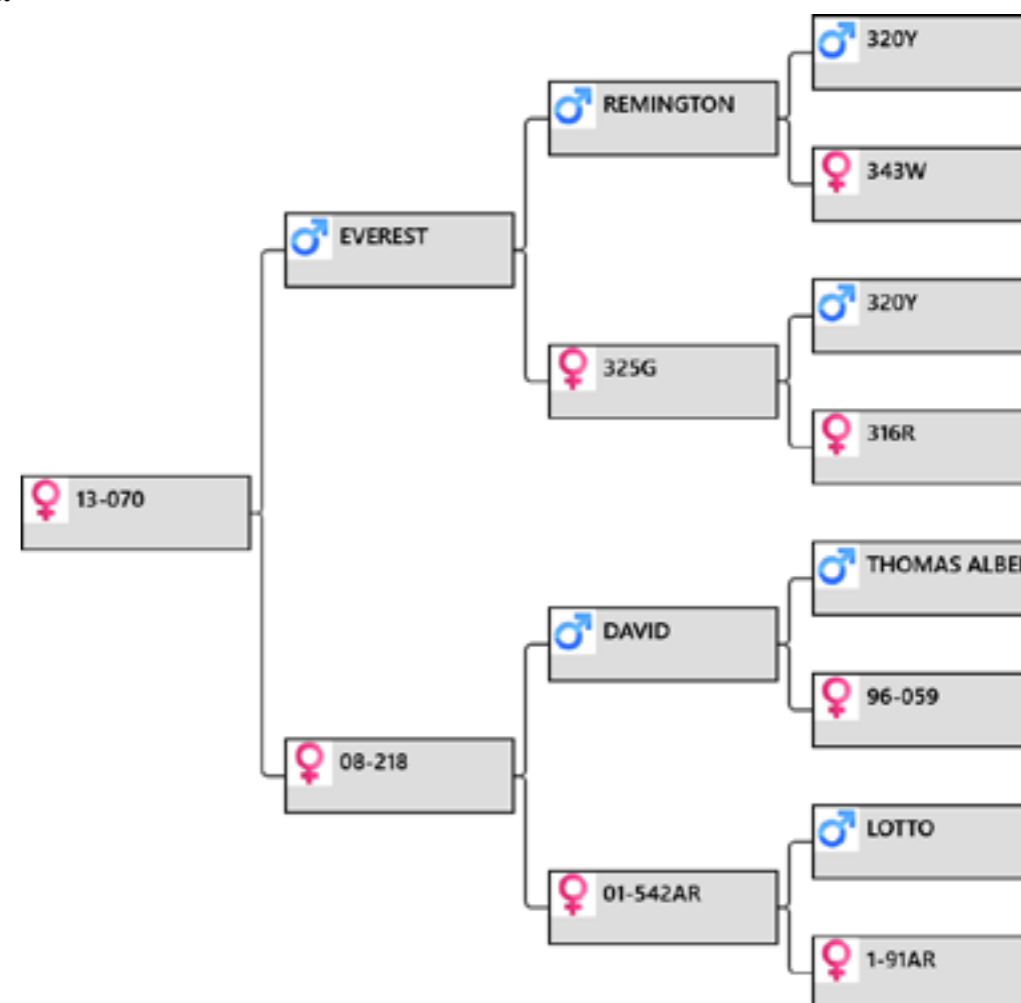

### Biography:

Everest and David back to good Arawata hind

Sale weight: Price: Buyer:

## lot # 36 – Yearling hind



Animal: **13-076**

Birthdate: 2013

Weigh Date	Weight
30/03/2014	68 kg
30/11/2014	95 kg

### Pedigree:

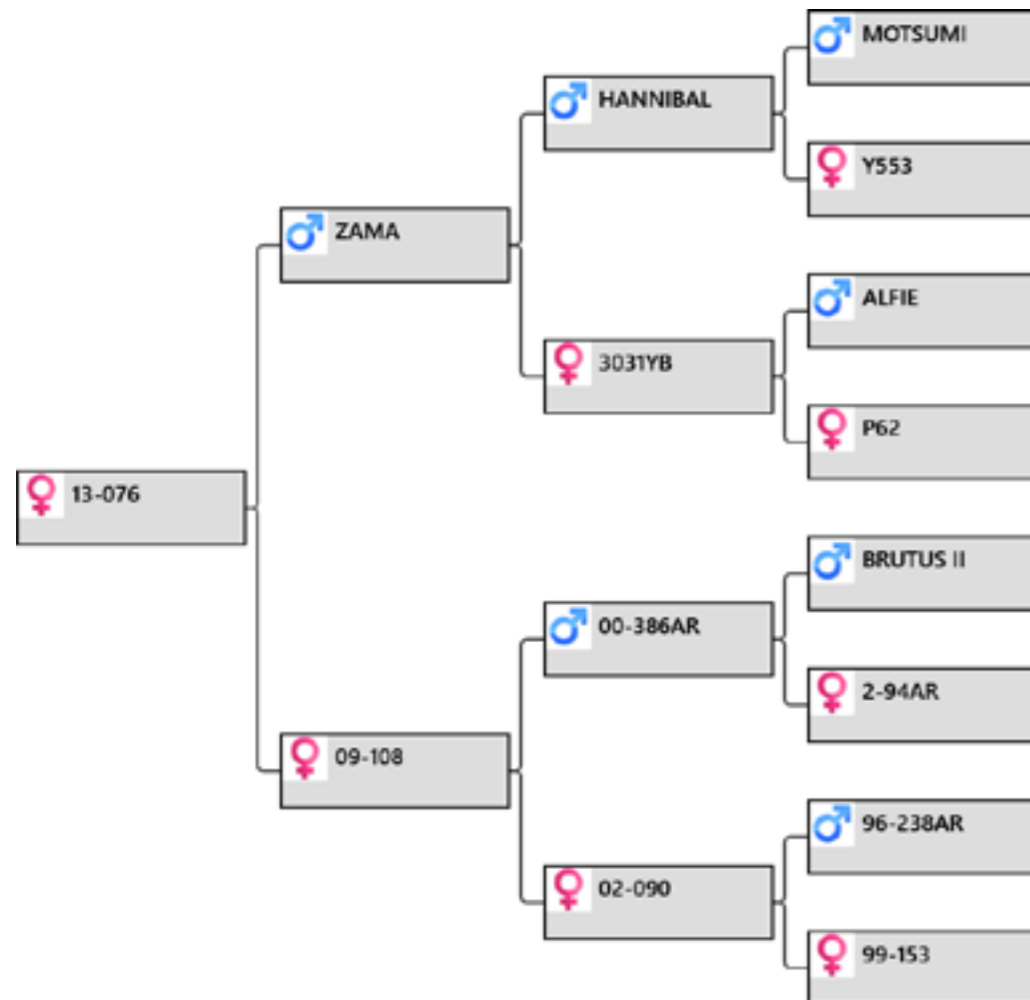

### Biography:

Zama died so will not be putting up many for sale in future

Sale weight: Price: Buyer:

## lot # 37 – Yearling hind



Animal: **13-079**

Birthdate: 2013

Weigh Date	Weight
30/03/2014	63 kg
30/11/2014	81 kg

### Pedigree:

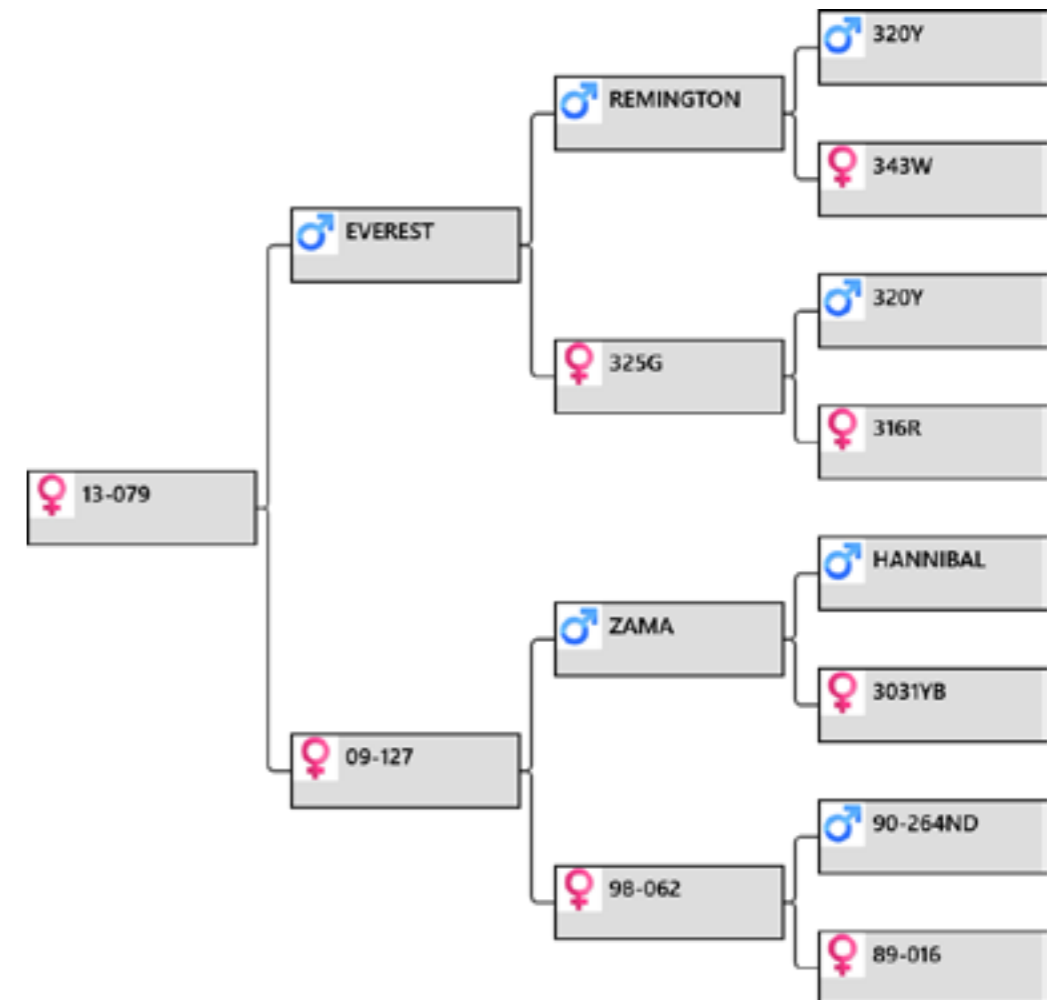

### Biography:

Everest over Zama back to top old hind 16-89, dam of a 2yr old stag cutting 4kg and a good trophy stag, plus her daughter 62-98 produced a very good trophy stag

Sale weight: Price: Buyer:

## lot # 38 – Yearling hind



performance recorded since 1985  
Yearling Hind sale 2015

Animal: **13-100**

---

Birthdate: 2013

Weigh Date	Weight
30/03/2014	63 kg
30/11/2014	83 kg

### Pedigree:

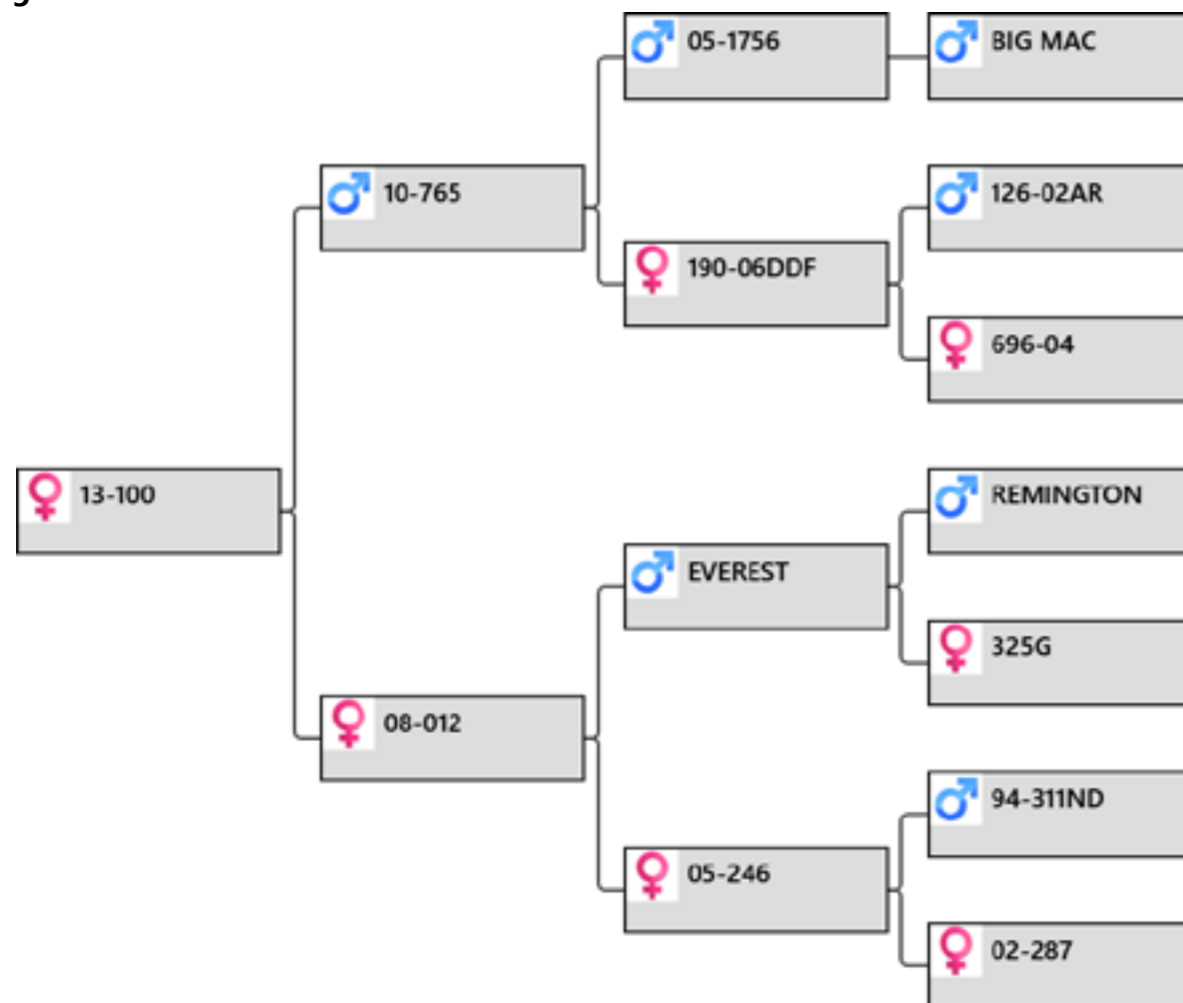

### Biography:

765-10 8.1kg 3yr over Everest daughter, should breed big velvet with 765-10 cutting a massive 7.8kg @2yr

Sale weight: Price: Buyer:

## lot # 39 – Yearling hind



performance recorded since 1985  
Yearling Hind sale 2015

Animal: **13-103**

---

Birthdate: 2013

Weigh Date	Weight
30/03/2014	64 kg
30/11/2014	91 kg

### Pedigree:

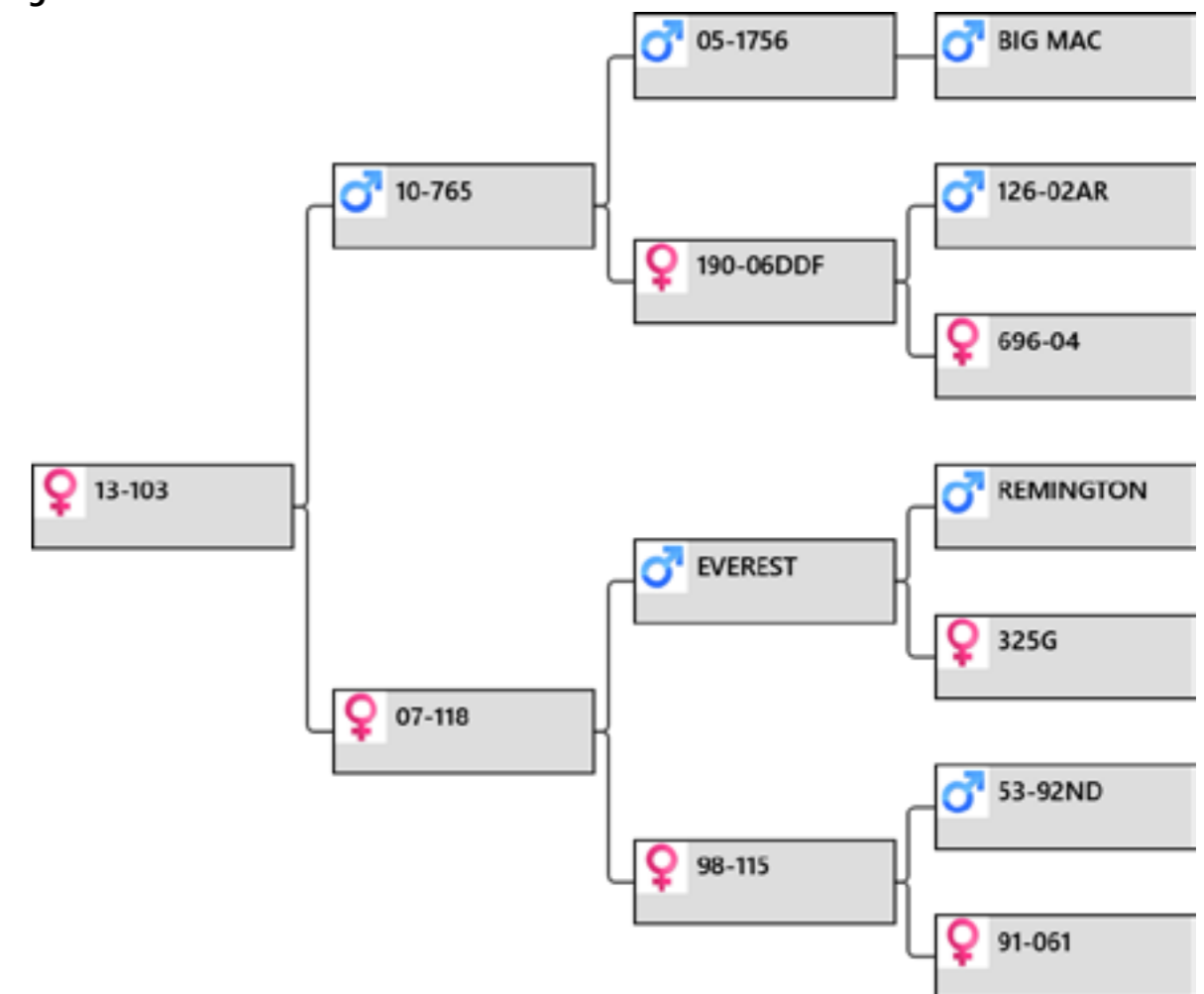

### Biography:

765-10 8.1kg 3yr old over Everest daughter should be good

Sale weight: Price: Buyer:



## lot # 40 – Yearling hind



Animal: <b>13-104</b>		
Birthdate: 2013		
<b>Weigh Date</b>	<b>Weight</b>	
30/03/2014	64 kg	
30/11/2014	93 kg	

### Pedigree:

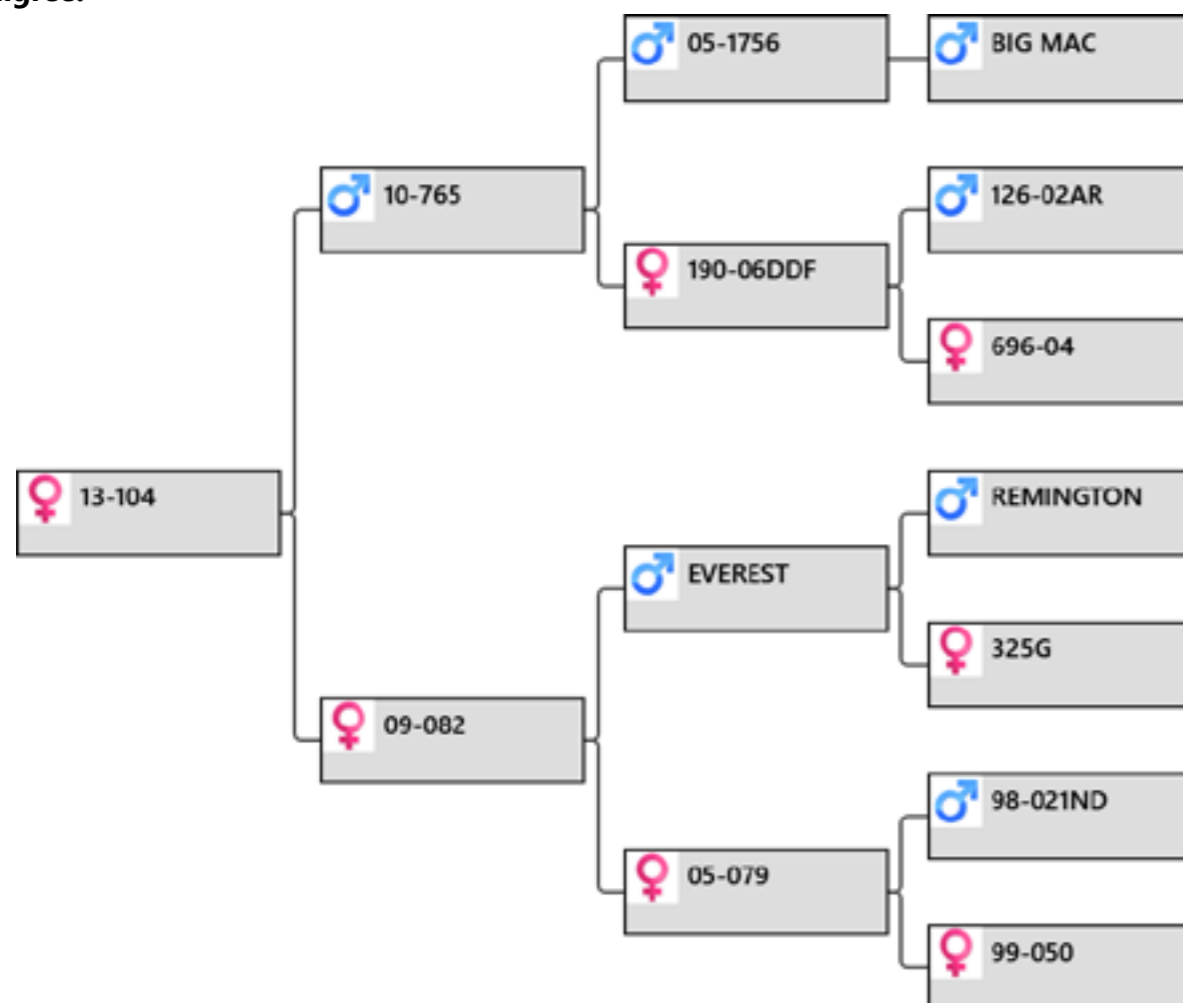

### Biography:

Grand dam 79-05 has produced a 4.05 kg 2yr old so with 765-10 and Everest 104-13 should bred well

Sale weight: Price: Buyer:

## lot # 41 – Yearling hind



Animal: <b>13-151</b>		
Birthdate: 2013		
<b>Weigh Date</b>	<b>Weight</b>	
30/03/2014	73 kg	
30/11/2014	95 kg	

### Pedigree:

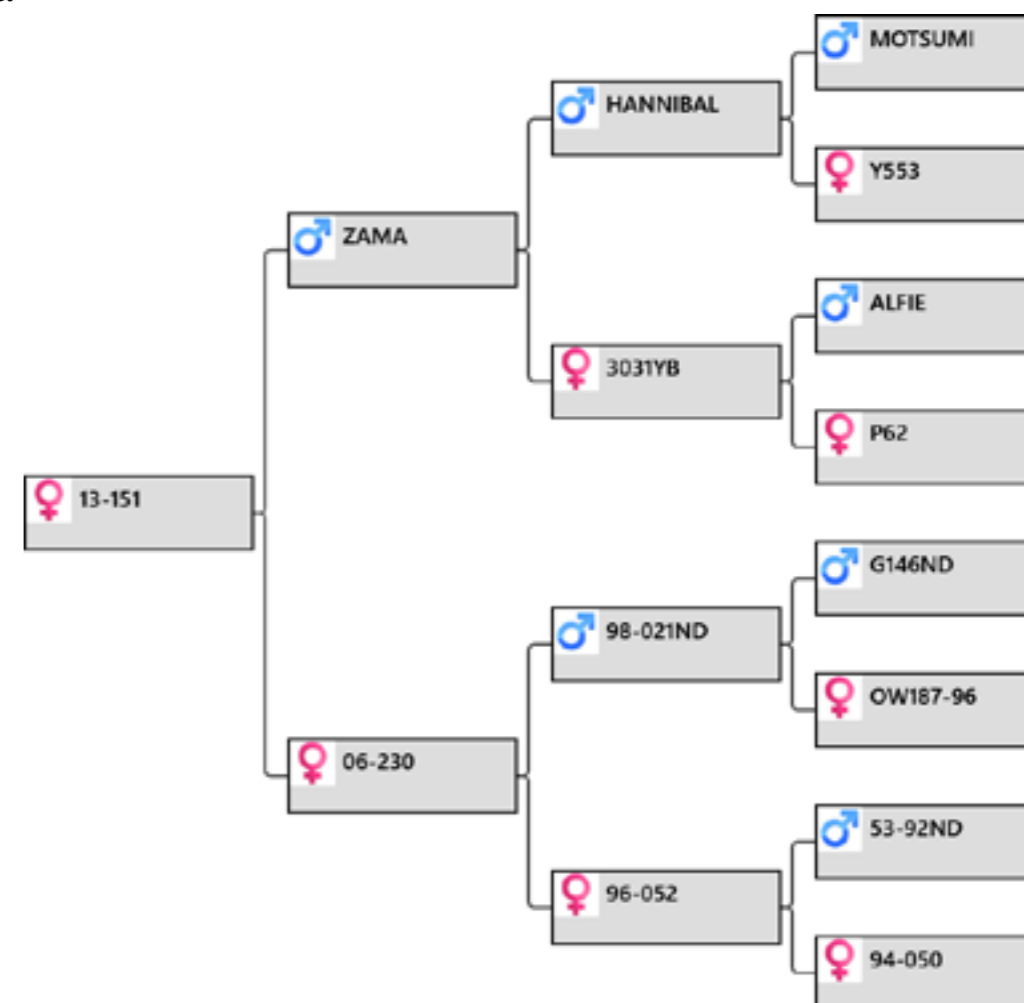

### Biography:

Zama with 52-96 on bottom line dam of sire used at Altrive and she is grand dam of sire 77-07 2nd place national 4yr competition

Sale weight: Price: Buyer:

## lot # 42 – Yearling hind



performance recorded since 1985

Yearling Hind sale 2015

Animal: **13-192**

Birthdate: 2013

Weigh Date	Weight
30/03/2014	63 kg
30/11/2014	92 kg

### Pedigree:

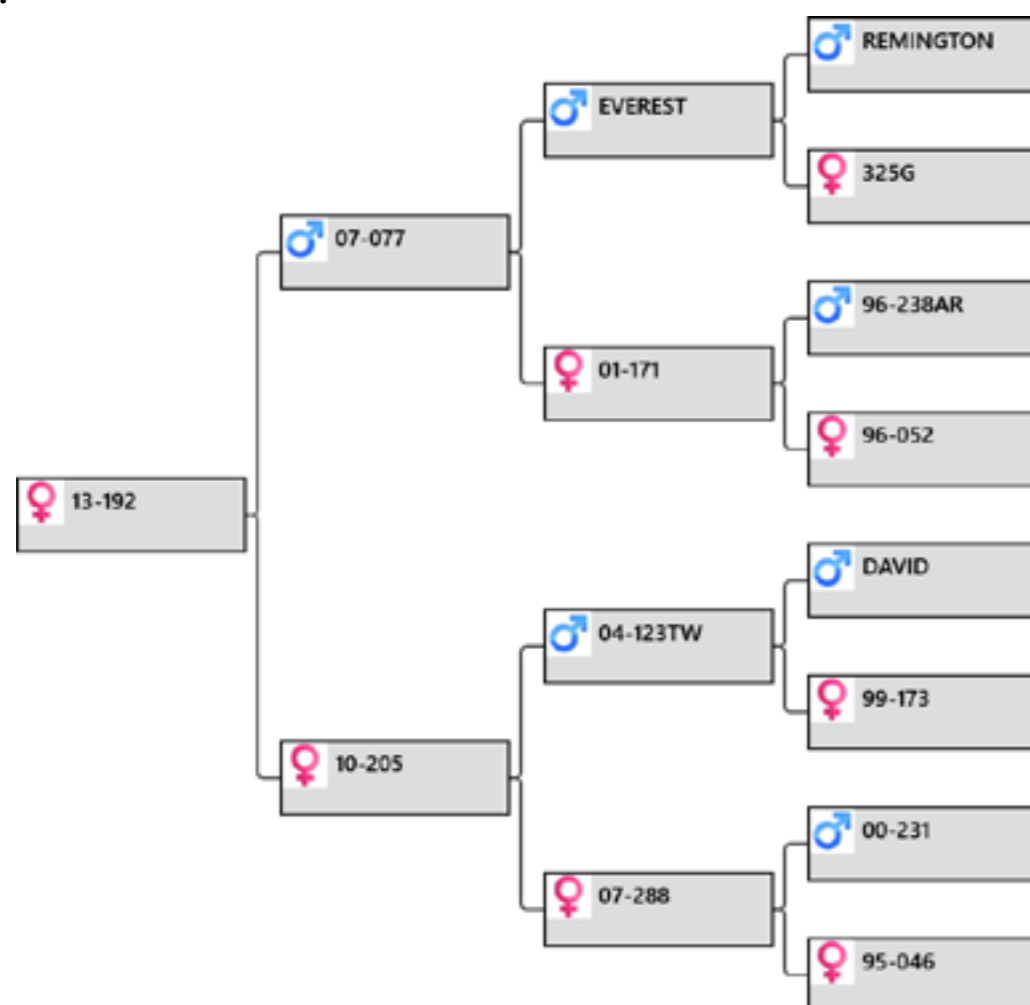

### Biography:

77-07 8.25kg 4yr old and 2nd place at nationals back to 46-95 who is the dam of our top donor hind 152-01 dam of lots 1 and 2 2012 sale

Sale weight:

Price:

Buyer:

## lot # 43 – Yearling hind



performance recorded since 1985

Yearling Hind sale 2015

Animal: **13-193**

Birthdate: 2013

Weigh Date	Weight
30/03/2014	66 kg
30/11/2014	98 kg

### Pedigree:

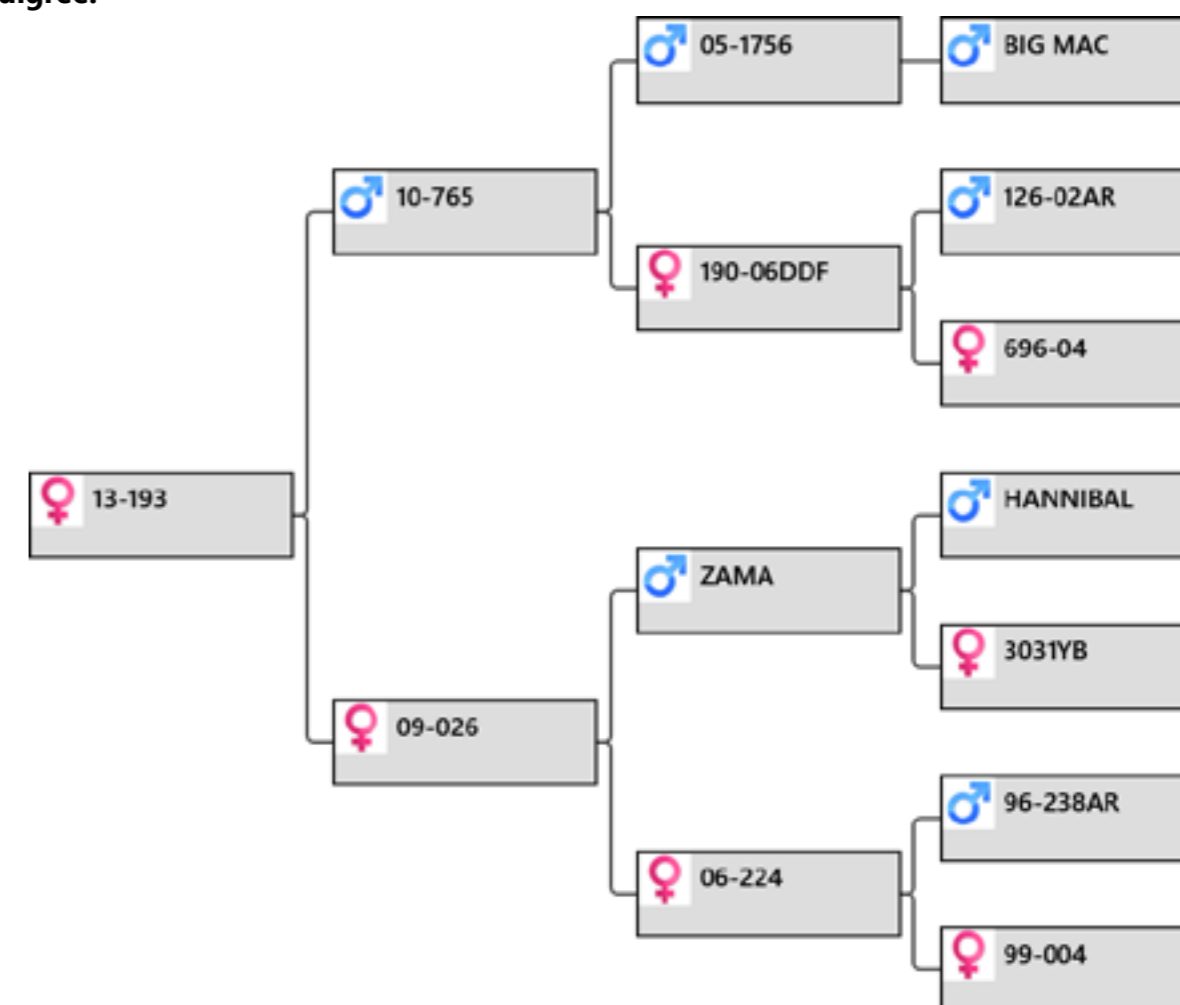

### Biography:

765-10 8.1kg 3yr over Zama 12.25kg out of a 238-96 daughter

Sale weight:

Price:

Buyer:

## lot # 44 – Yearling hind



Animal: **13-198**

Birthdate: 2013

Weigh Date	Weight
30/03/2014	60 kg
30/11/2014	88 kg

### Pedigree:

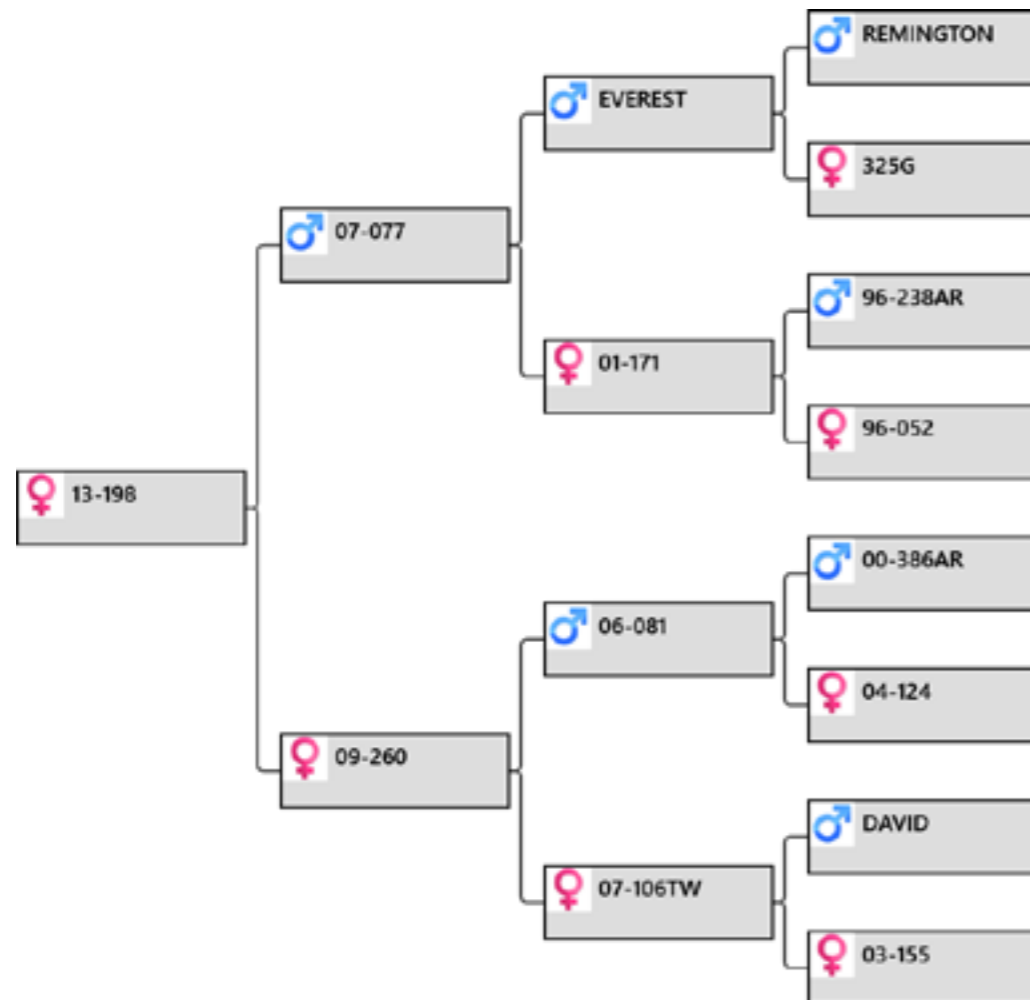

### Biography:

77-07 8.25kg 4 yr over 81-06 11.8 7 yr

Sale weight: Price: Buyer:

## lot # 45 – Yearling hind



Animal: **13-205**

Birthdate: 2013

Weigh Date	Weight
30/03/2014	63 kg
30/11/2014	92 kg

### Pedigree:

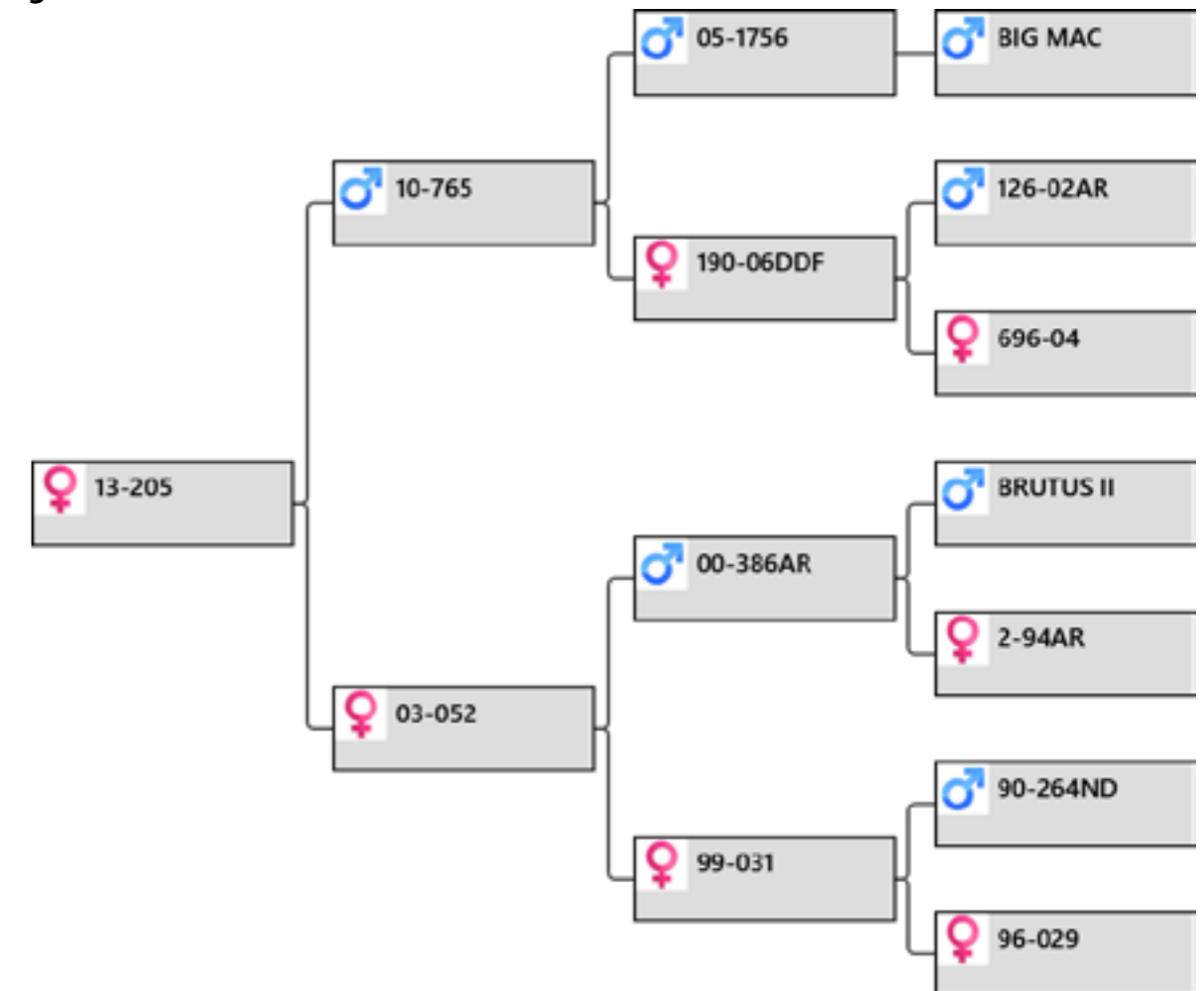

### Biography:

52-03 is the dam of 59-07 sold as sire 2010

Sale weight: Price: Buyer:

## lot # 46 – Yearling hind



performance recorded since 1985

Yearling Hind sale 2015

Animal: **13-219**

Birthdate: 2013

Weigh Date	Weight
30/03/2014	48 kg
30/11/2014	78 kg

### Pedigree:

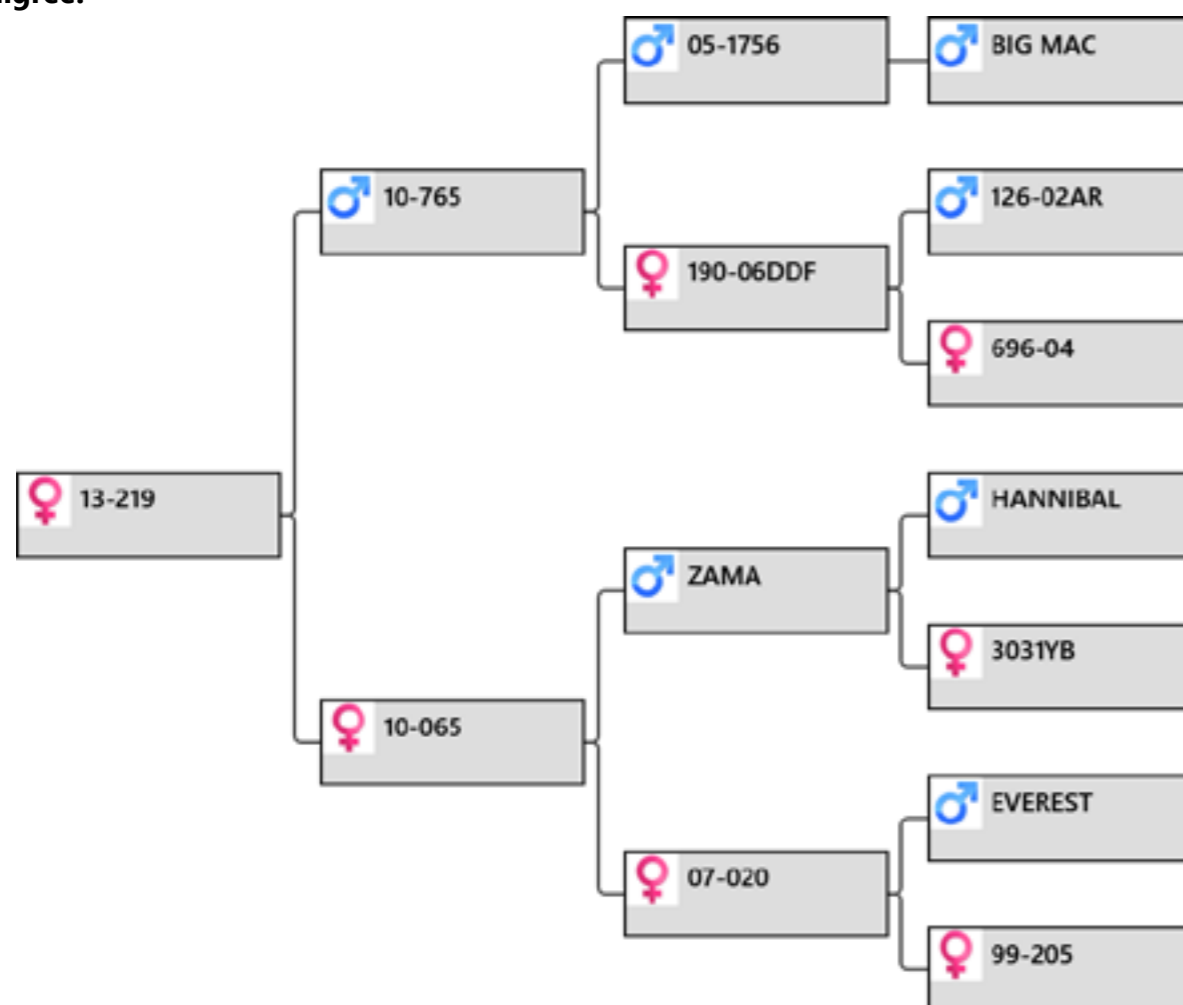

### Biography:

765-10 8.1kg 3yr old over Zama 12.25kg and Everest 12.25kg

Sale weight:

Price:

Buyer:

## lot # 47 – Yearling hind



performance recorded since 1985

Yearling Hind sale 2015

Animal: **13-222**

Birthdate: 2013

Weigh Date	Weight
30/03/2014	64 kg
30/11/2014	90 kg

### Pedigree:

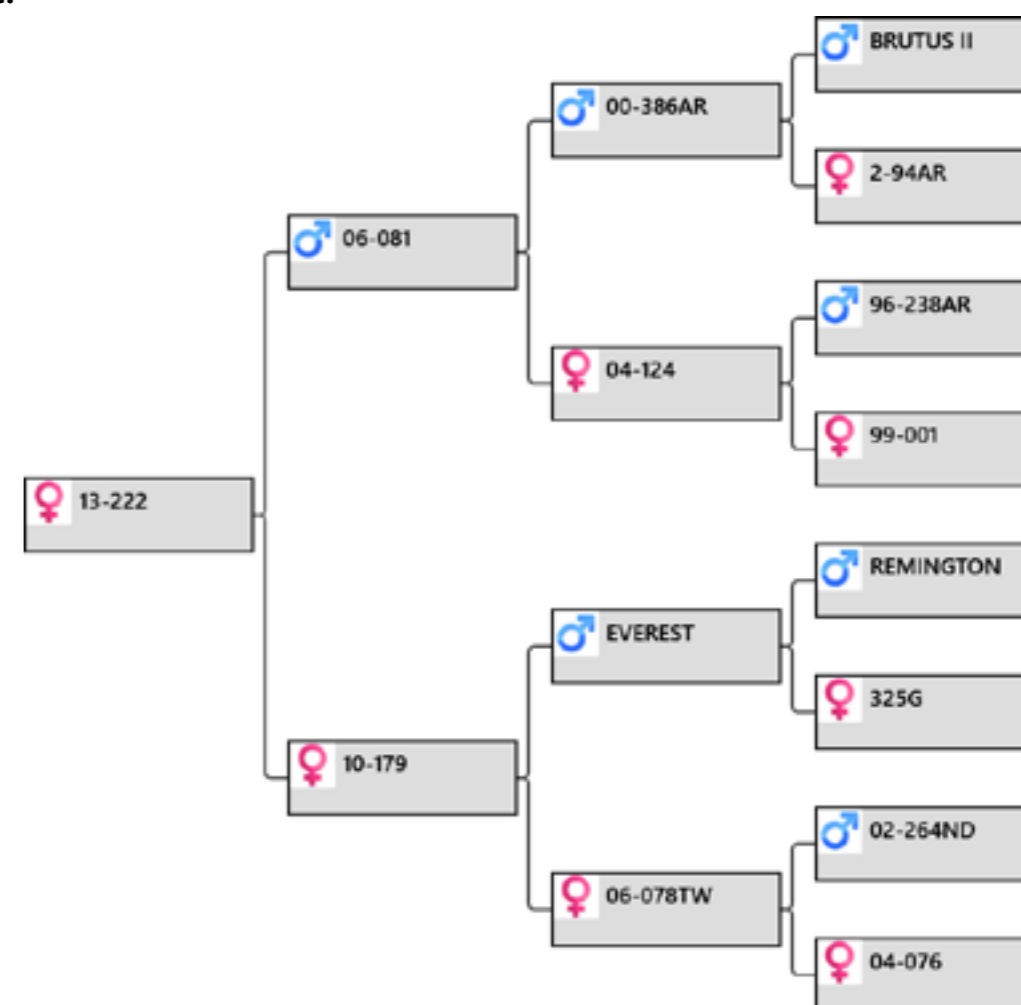

### Biography:

81-06 11.8kg 7yr over Everest 12.25kg back to 76-04 who had a son sold last year for \$4000

Sale weight:

Price:

Buyer:



## lot # 48 – Yearling hind



Animal: **13-236**

Birthdate: 2013

Weigh Date	Weight
30/03/2014	55 kg
30/11/2014	81 kg

### Pedigree:

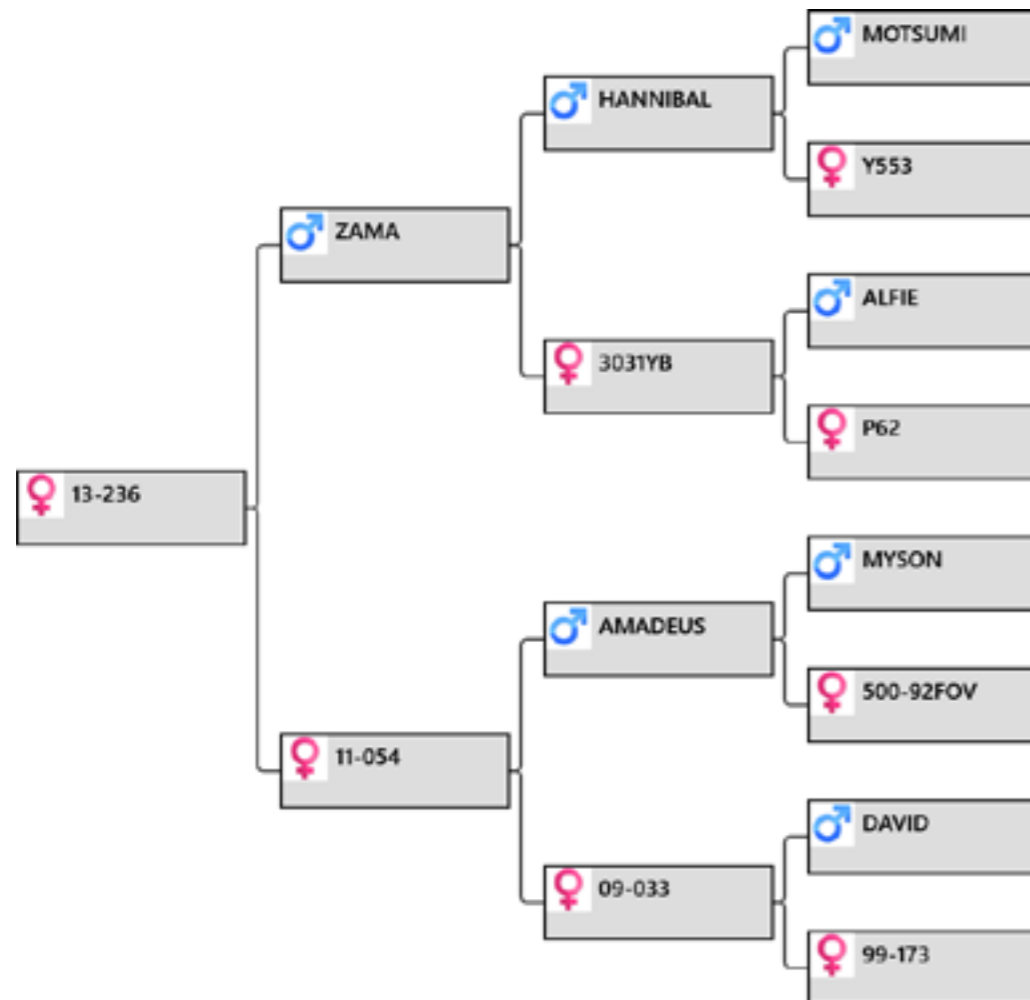

### Biography:

33-09 full sister to 123-04 502 IOA @ 4yr then Amadeus over her, then Zama over 54-11 has to be good for velvet and trophy

Sale weight: Price: Buyer:

## lot # 49 – Yearling hind



Animal: **13-238**

Birthdate: 2013

Weigh Date	Weight
30/03/2014	46 kg
30/11/2014	84 kg

### Pedigree:

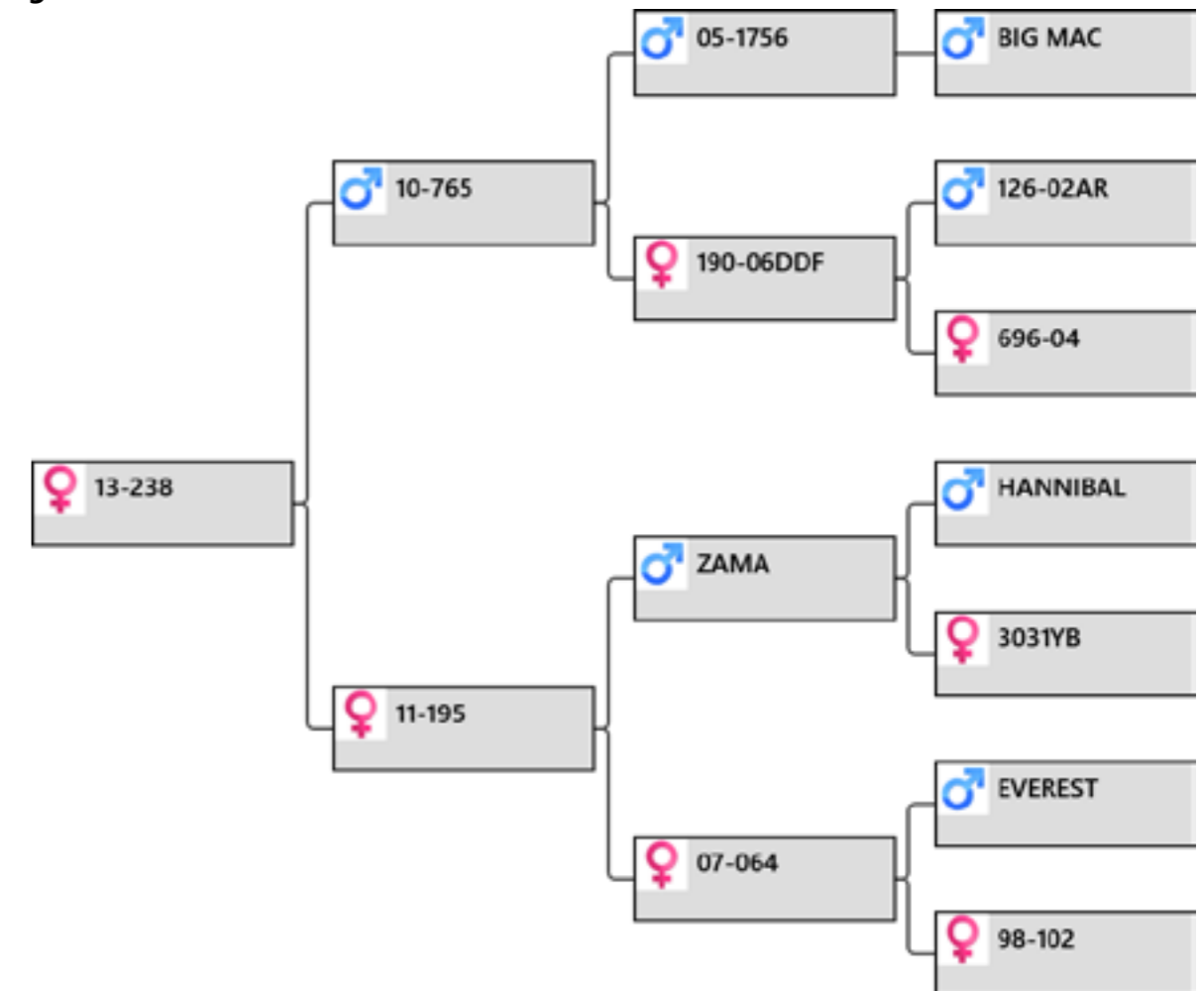

### Biography:

195-11 a Zama daughter out of an Everest daughter then 765-10 7.8kg @ 2yr to produce 238-13 a top hind

Sale weight: Price: Buyer:

## lot # 50 – Yearling hind



Animal: **13-239**

Birthdate: 2013

Weigh Date	Weight
30/03/2014	60 kg
30/11/2014	89 kg

### Pedigree:

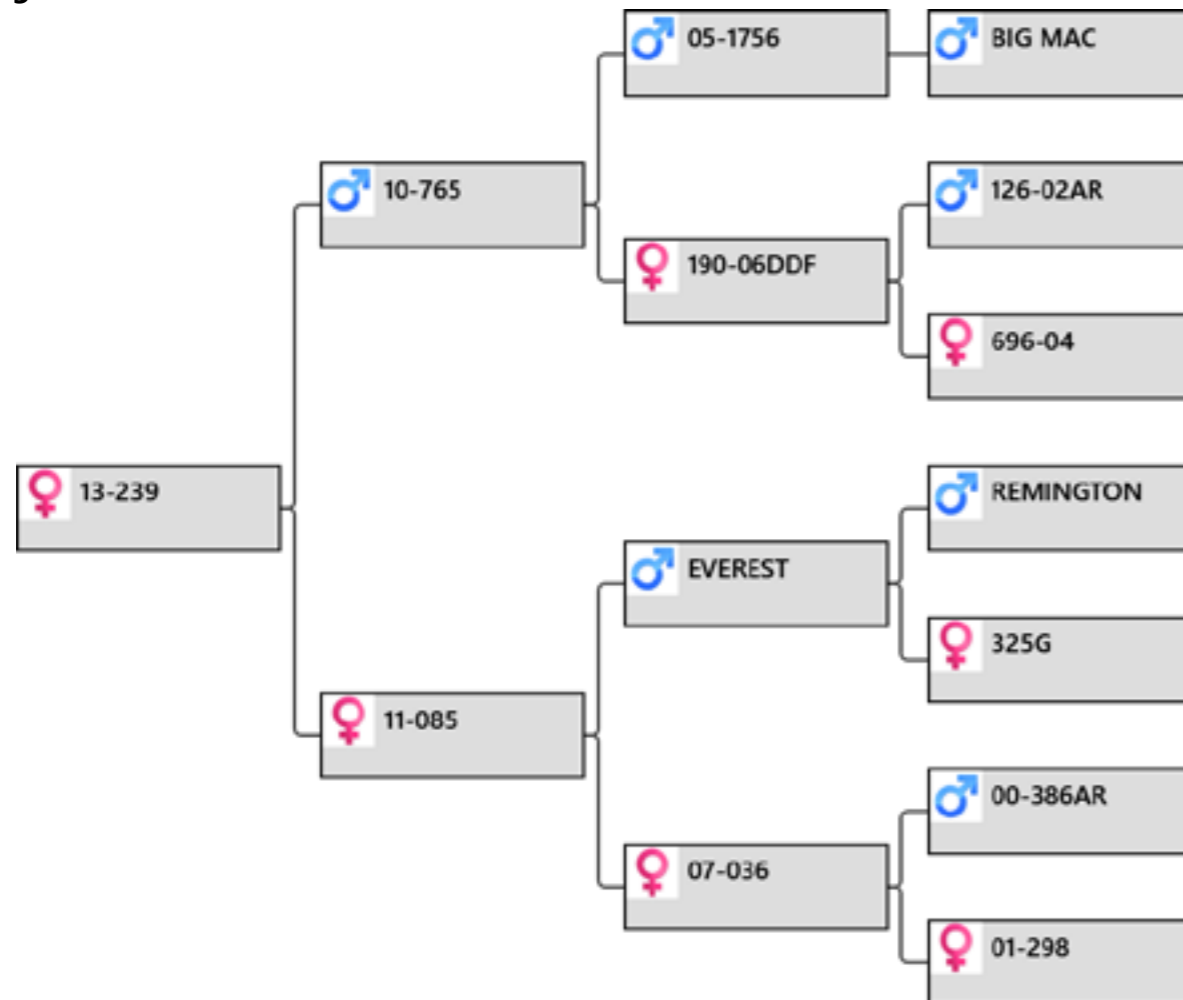

### Biography:

Top pedigree right back to 298-01 dam of 2 sire stags sold at auction for \$9000 and \$4800 plus a good trophy stag

Sale weight: Price: Buyer:

## lot # 51 – Yearling hind



Animal: **13-249**

Birthdate: 2013

Weigh Date	Weight
30/03/2014	52 kg
30/11/2014	87 kg

### Pedigree:

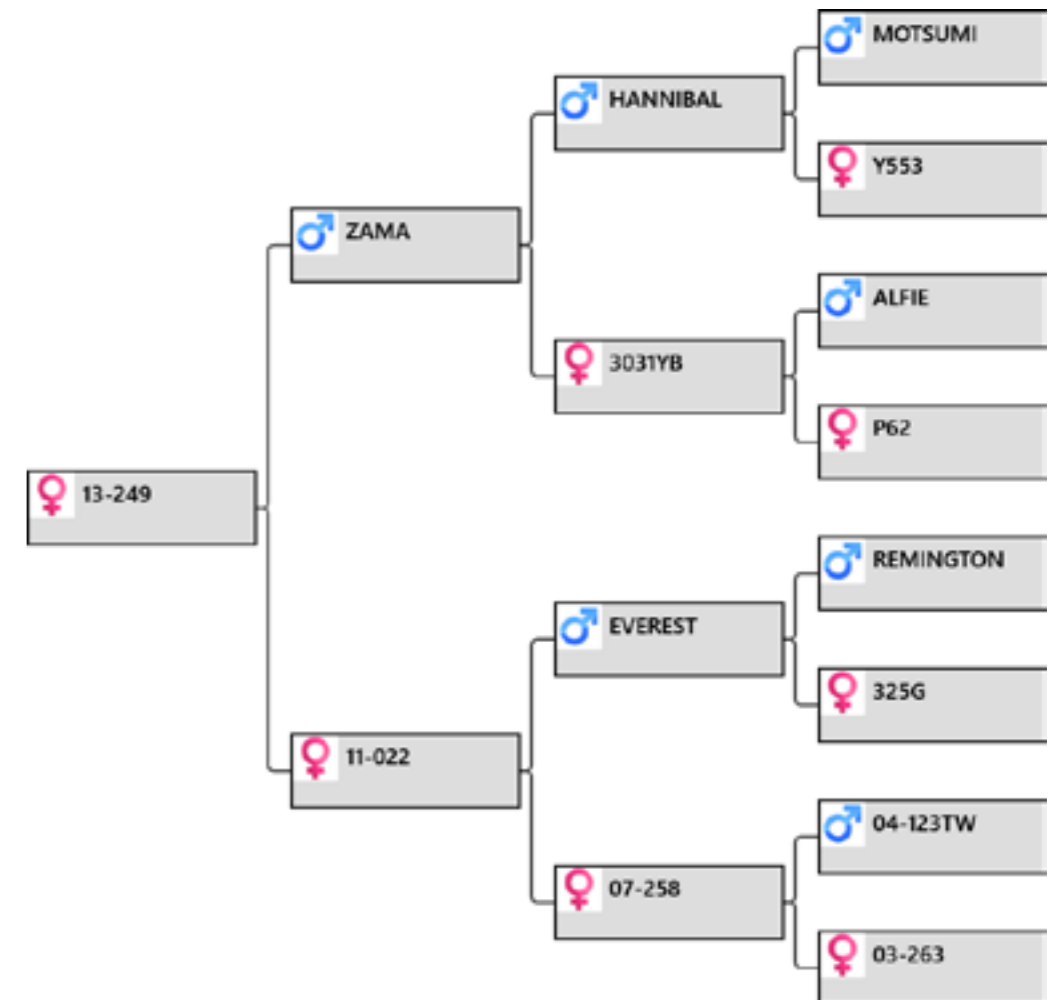

### Biography:

Zama and Everest back to 263-03 who has 2 sons cutting over 4kg @2yr

Sale weight: Price: Buyer:

## lot # 52 – Yearling hind



performance recorded since 1985

Yearling Hind sale 2015

Animal: **13-250**

Birthdate: 2013

Weigh Date	Weight
30/03/2014	60 kg
30/11/2014	78 kg

### Pedigree:

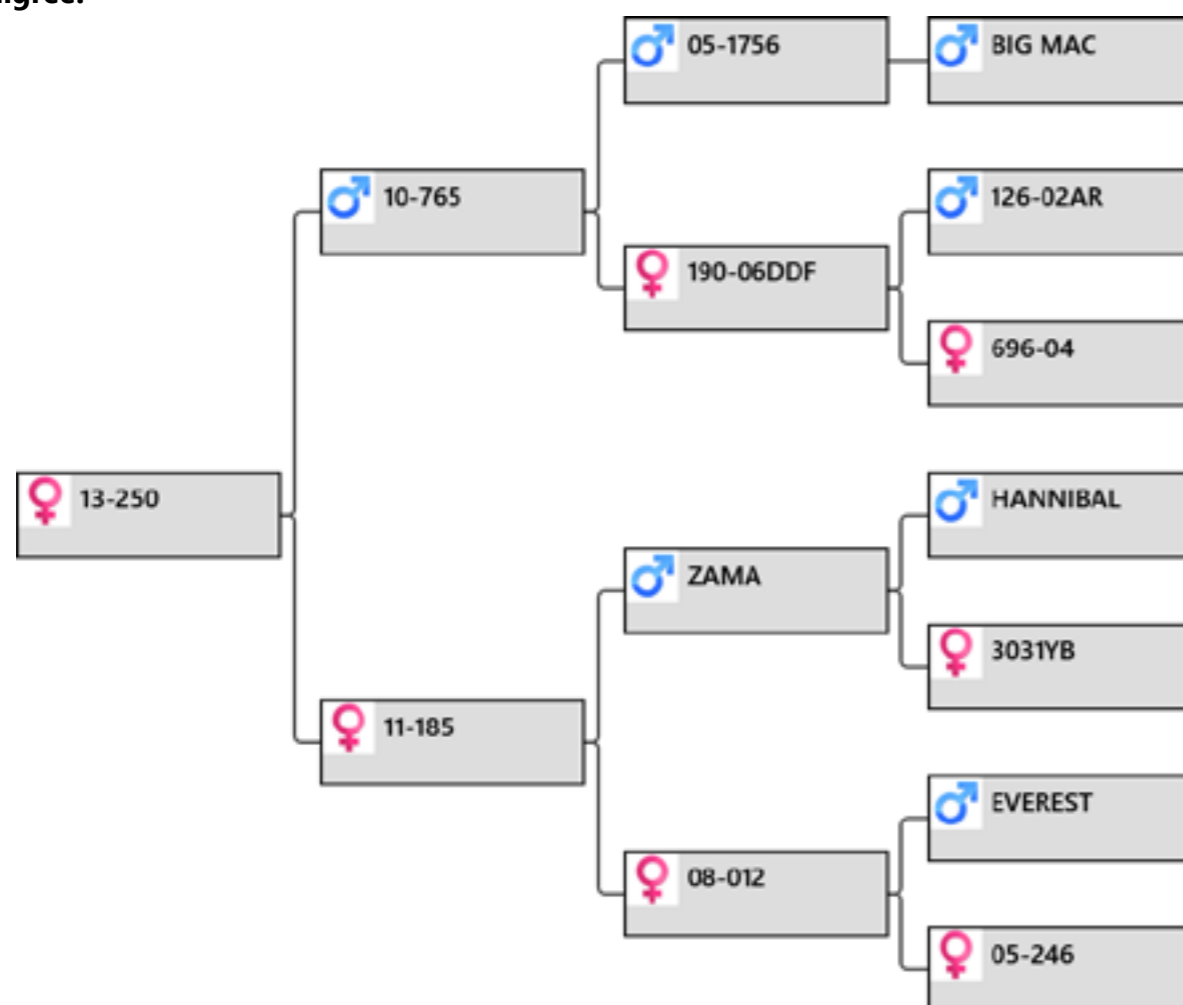

### Biography:

765-10 8.1kg 3yr old plus Zama an Everest!

Sale weight: Price: Buyer:

## lot # 53 – Yearling hind



performance recorded since 1985

Yearling Hind sale 2015

Animal: **13-259**

Birthdate: 2013

Weigh Date	Weight
30/03/2014	58 kg
30/11/2014	89 kg

### Pedigree:

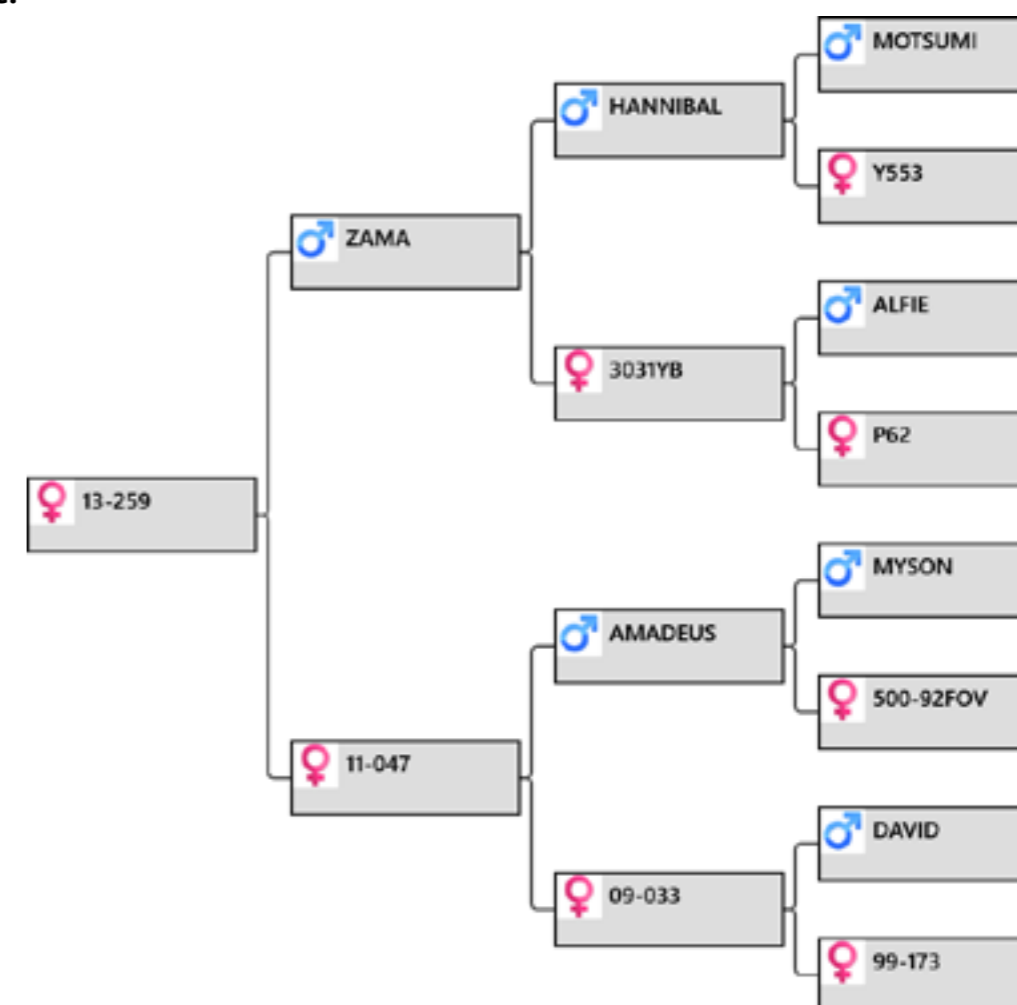

### Biography:

33-09 full sister to Altrive 123-04 502 IOA @4yr then Amadeus over her, then Zama over 47-11 has to be good for velvet and trophy.

Sale weight: Price: Buyer:

## lot # 54 – Yearling hind



Animal: **13-262**

Birthdate: 2013

Weigh Date	Weight
30/03/2014	45 kg
30/11/2014	78 kg

### Pedigree:

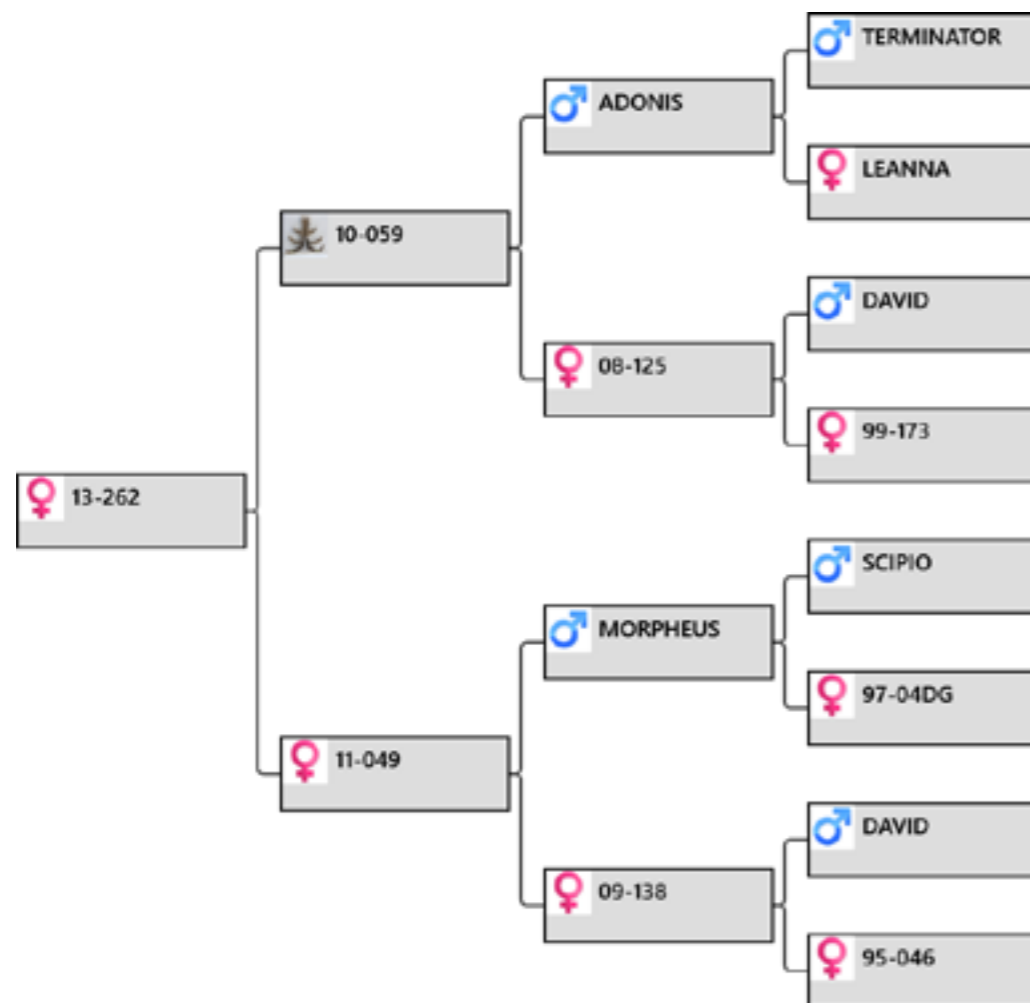

### Biography:

138-09 full sister to 186-04 sold as sire to Alan Stewart. Morpheus over her then Adonis son 59-10 out of 125-08 full sister to 123-04 502 IOA @ 4yr. 59-10 sold 2013 sale.

Sale weight: Price: Buyer:

## lot # 55 – Yearling hind



Animal: **13-273**

Birthdate: 2013

Weigh Date	Weight
30/03/2014	59 kg
30/11/2014	97 kg

### Pedigree:

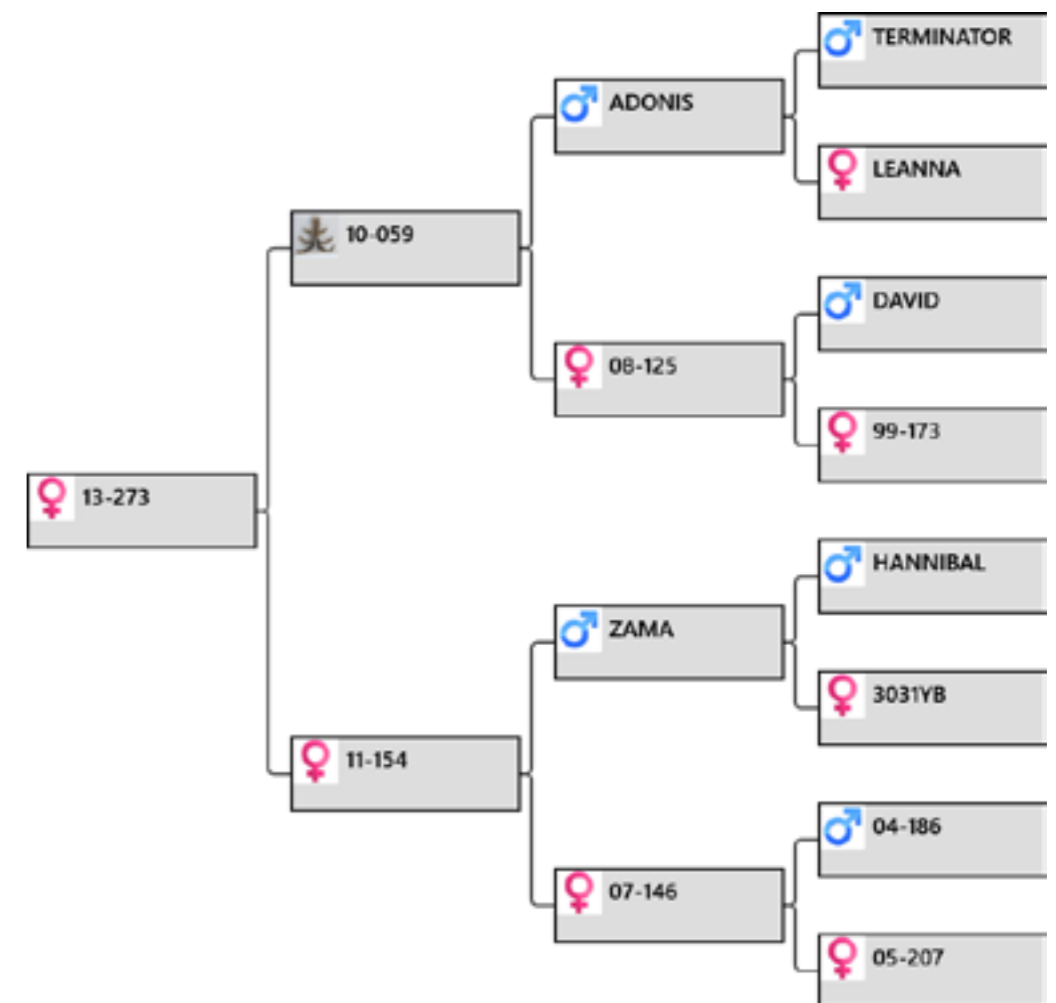

### Biography:

Adonis, Zama and 186-04 sold to Alan Stewart. trophy and velvet potential. 59-10 sold 2013 sale

Sale weight: Price: Buyer:



## lot # 56 – Yearling hind



performance recorded since 1985

Yearling Hind sale 2015

Animal: **13-276**

Birthdate: 2013

Weigh Date	Weight
30/03/2014	67 kg
30/11/2014	98 kg

### Pedigree:

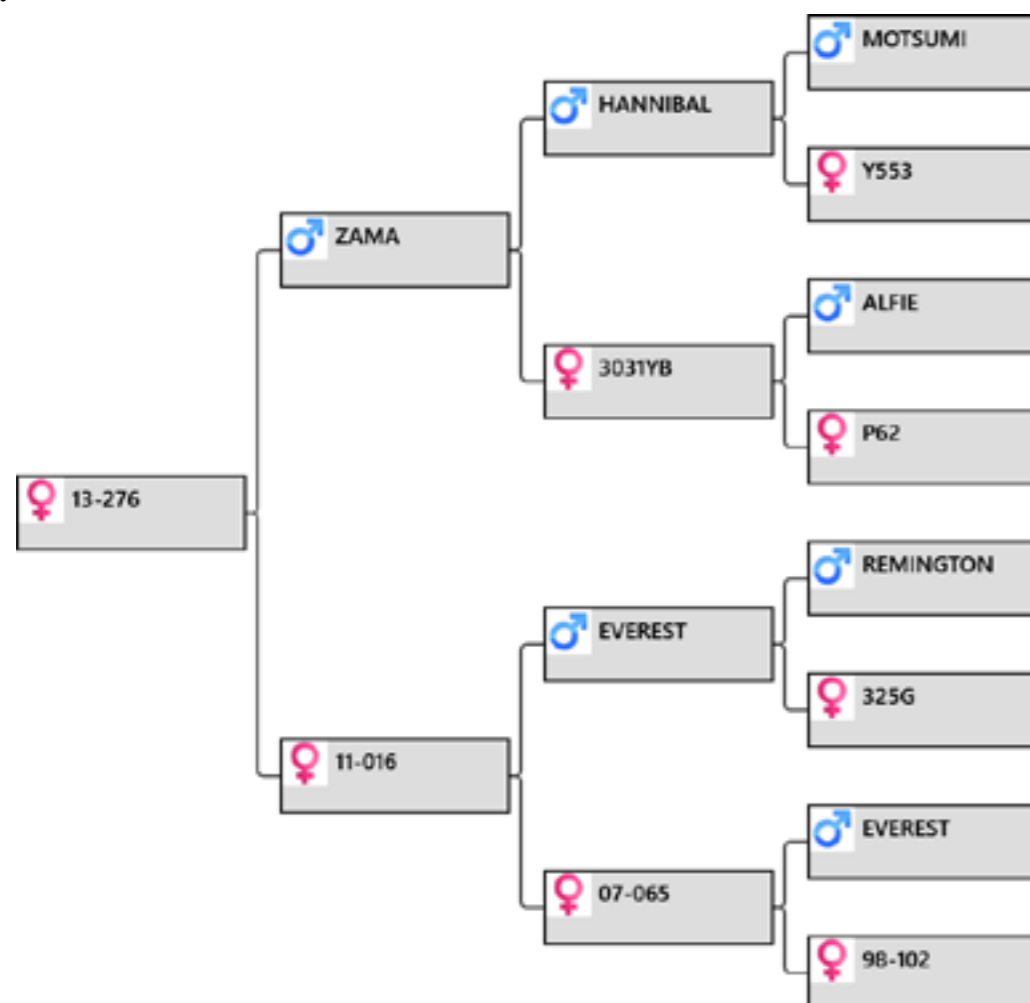

### Biography:

Zama plus double shot of Everest!

Sale weight: Price: Buyer:

## lot # 57 – Yearling hind



performance recorded since 1985

Yearling Hind sale 2015

Animal: **13-277**

Birthdate: 2013

Weigh Date	Weight
30/03/2014	58 kg
30/11/2014	87 kg

### Pedigree:

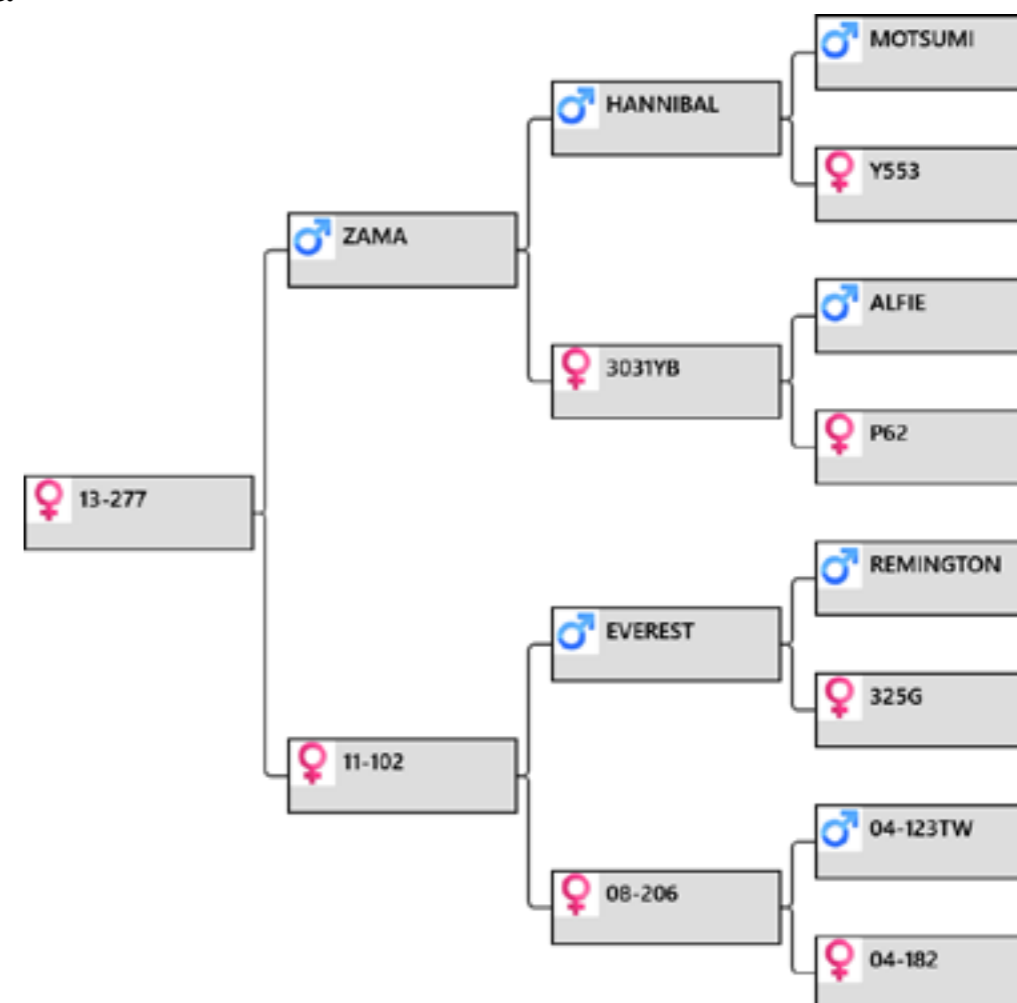

### Biography:

top breeding again

Sale weight: Price: Buyer:

## lot # 58 – Yearling hind



performance recorded since 1985

Yearling Hind sale 2015

Animal: **13-278**

Birthdate: 2013

Weigh Date	Weight
30/03/2014	61 kg
30/11/2014	87 kg

### Pedigree:

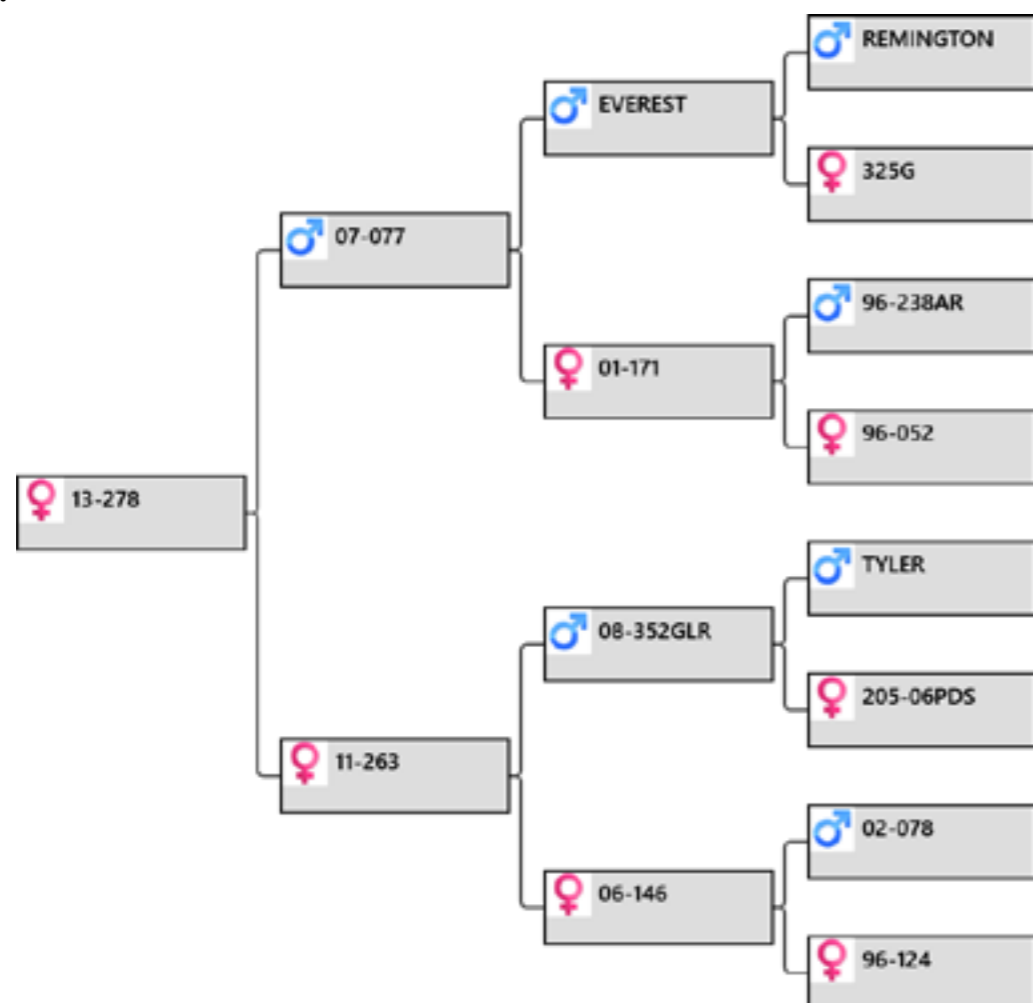

### Biography:

77-07 over GLR 352-08 sire of 258-11 8.5kg 3yr old in this catalogue

Sale weight: Price: Buyer:

## lot # 59 – Yearling hind



performance recorded since 1985

Yearling Hind sale 2015

Animal: **13-282**

Birthdate: 2013

Weigh Date	Weight
30/03/2014	59 kg
30/11/2014	96 kg

### Pedigree:

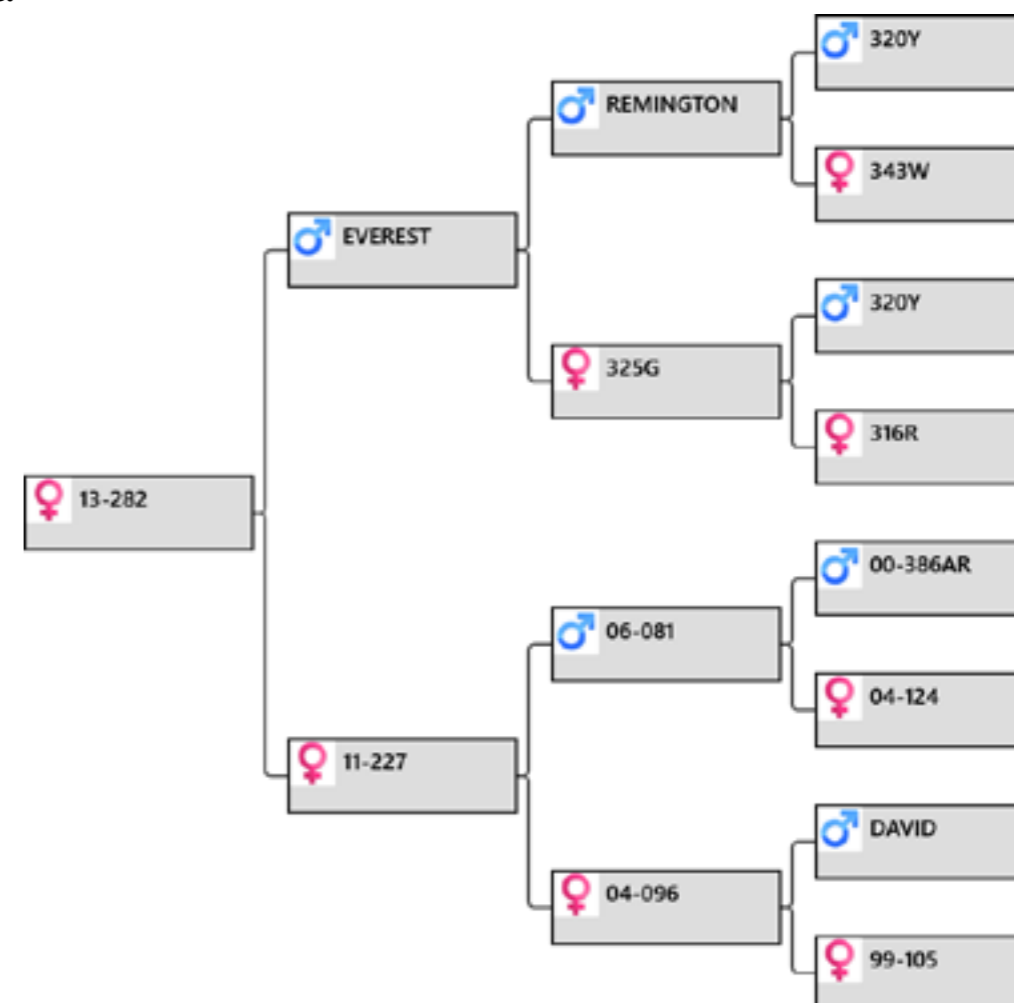

### Biography:

Everest, 81-06 and David

Sale weight: Price: Buyer:

## lot # 60 – Yearling hind



Animal: **13-284**

Birthdate: 2013

Weigh Date	Weight
30/03/2014	63 kg
30/11/2014	86 kg

performance recorded since 1985  
Yearling Hind sale 2015

### Pedigree:

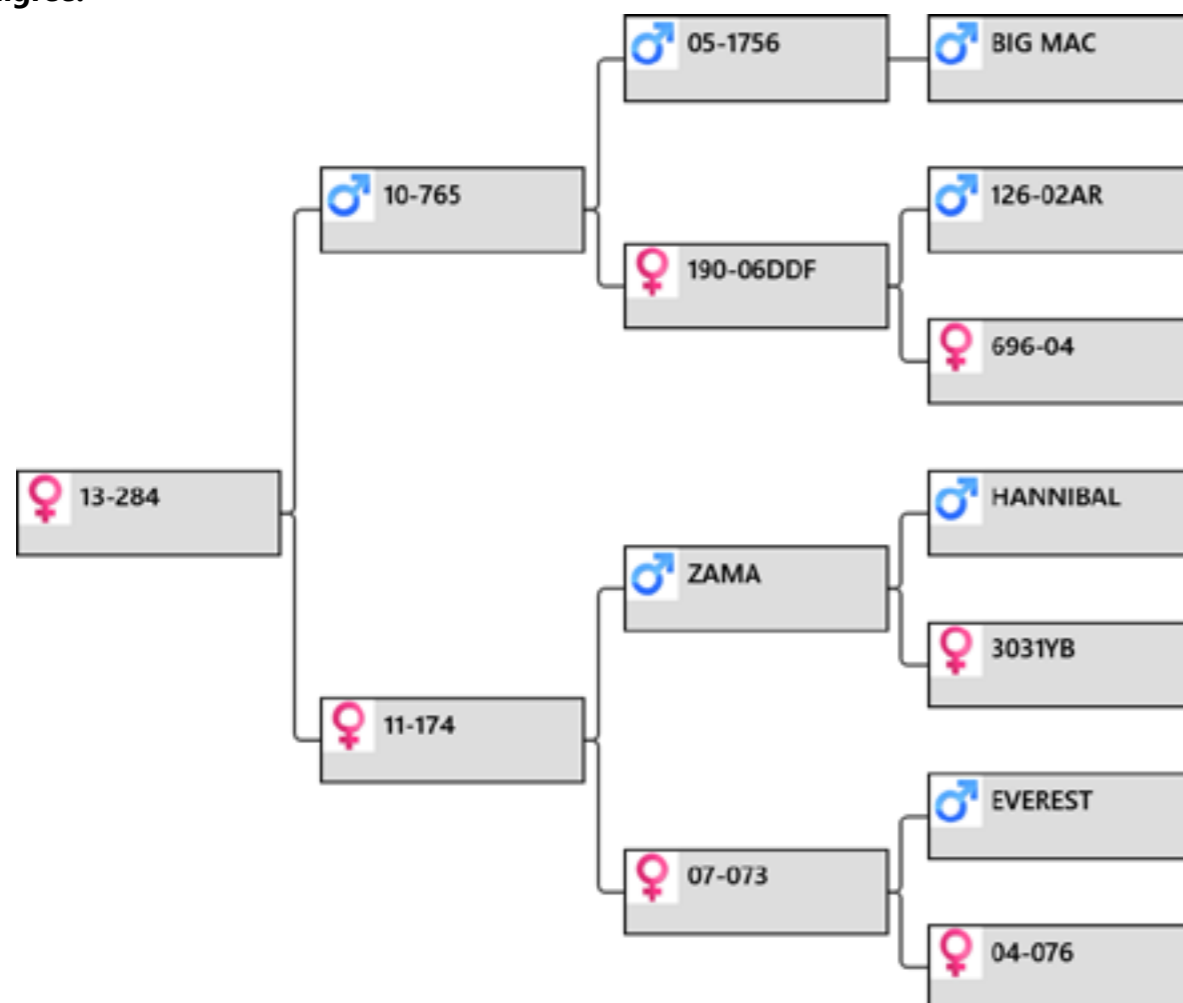

### Biography:

Top genetics 765-10 , Zama . Everest right back to 76-04 dam of 3yr old cutting 6.7kg

Sale weight: Price: Buyer:

## lot # 61 – Yearling hind



Animal: **13-290**

Birthdate: 2013

Weigh Date	Weight
30/03/2014	60 kg
30/11/2014	86 kg

performance recorded since 1985  
Yearling Hind sale 2015

### Pedigree:

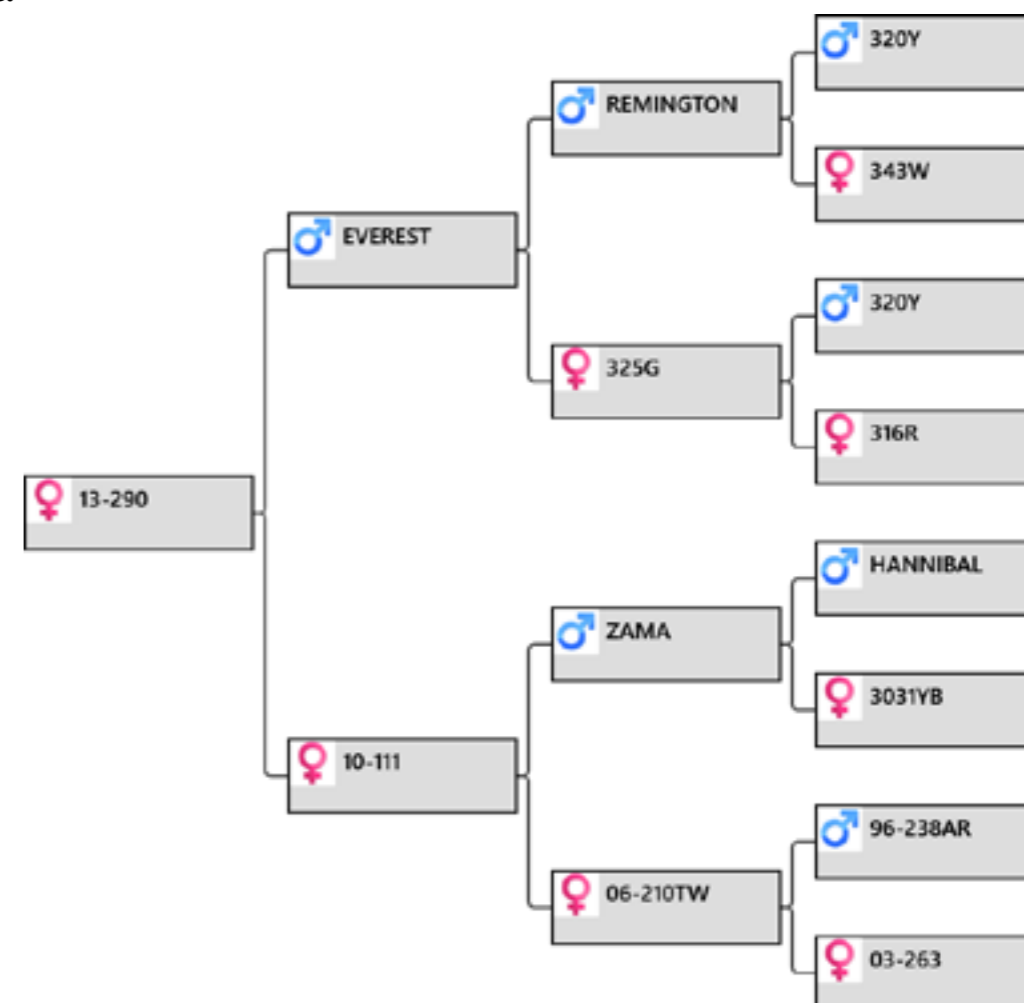

### Biography:

Everest ,Zama back to 263-03 top hind with sons cutting 4.05 and 4.35 @2yr old

Sale weight: Price: Buyer:

## lot # 62 – Yearling hind



performance recorded since 1985

Yearling Hind sale 2015

Animal: **13-291**

Birthdate: 2013

Weigh Date	Weight
30/03/2014	50 kg
30/11/2014	86 kg

### Pedigree:

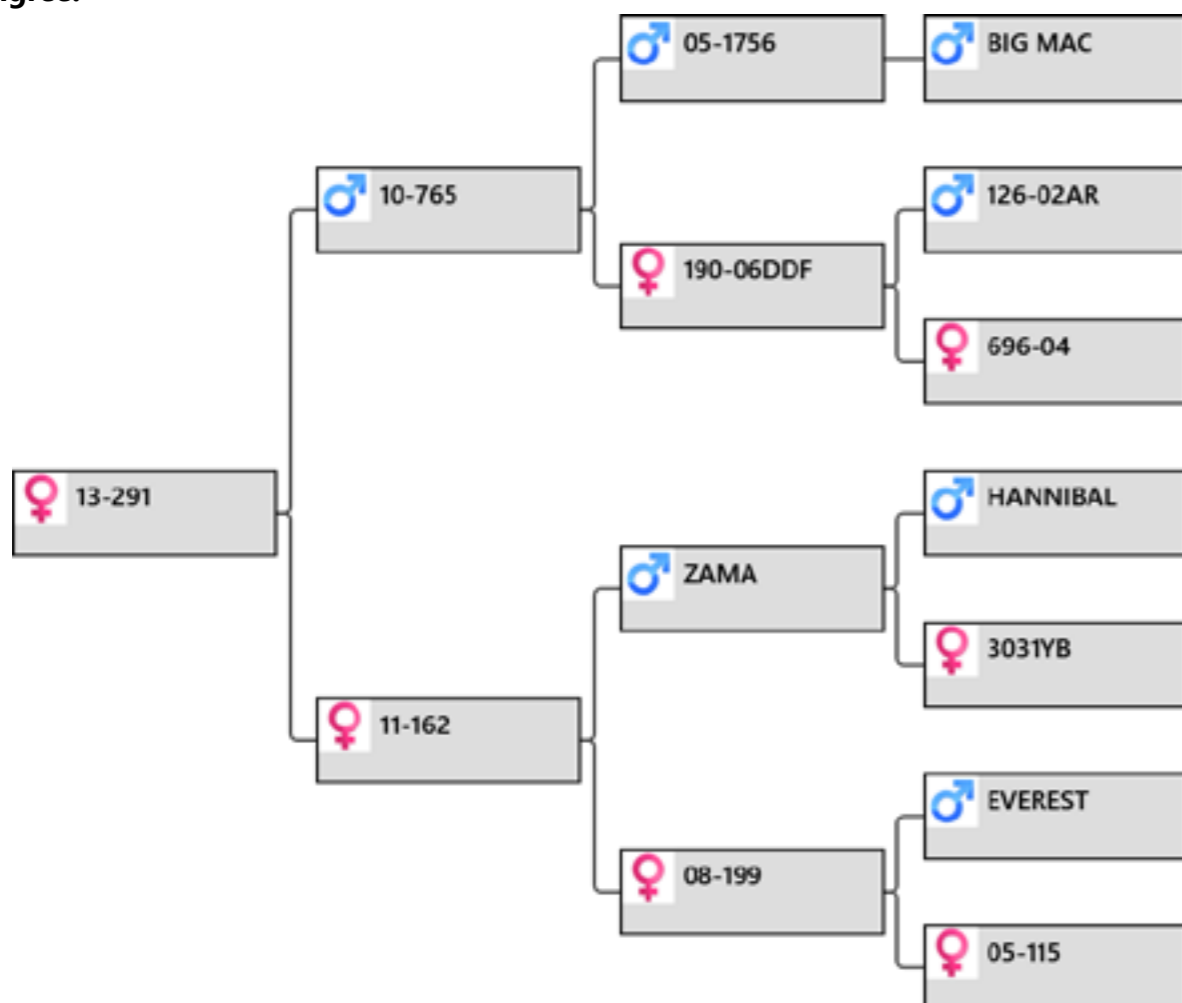

### Biography:

Zama ,Everest, 765-10 and out of a first fawner. Top hind

Sale weight: Price: Buyer:

## lot # 63 – Yearling hind



performance recorded since 1985

Yearling Hind sale 2015

Animal: **13-292**

Birthdate: 2013

Weigh Date	Weight
30/03/2014	55 kg
30/11/2014	82 kg

### Pedigree:

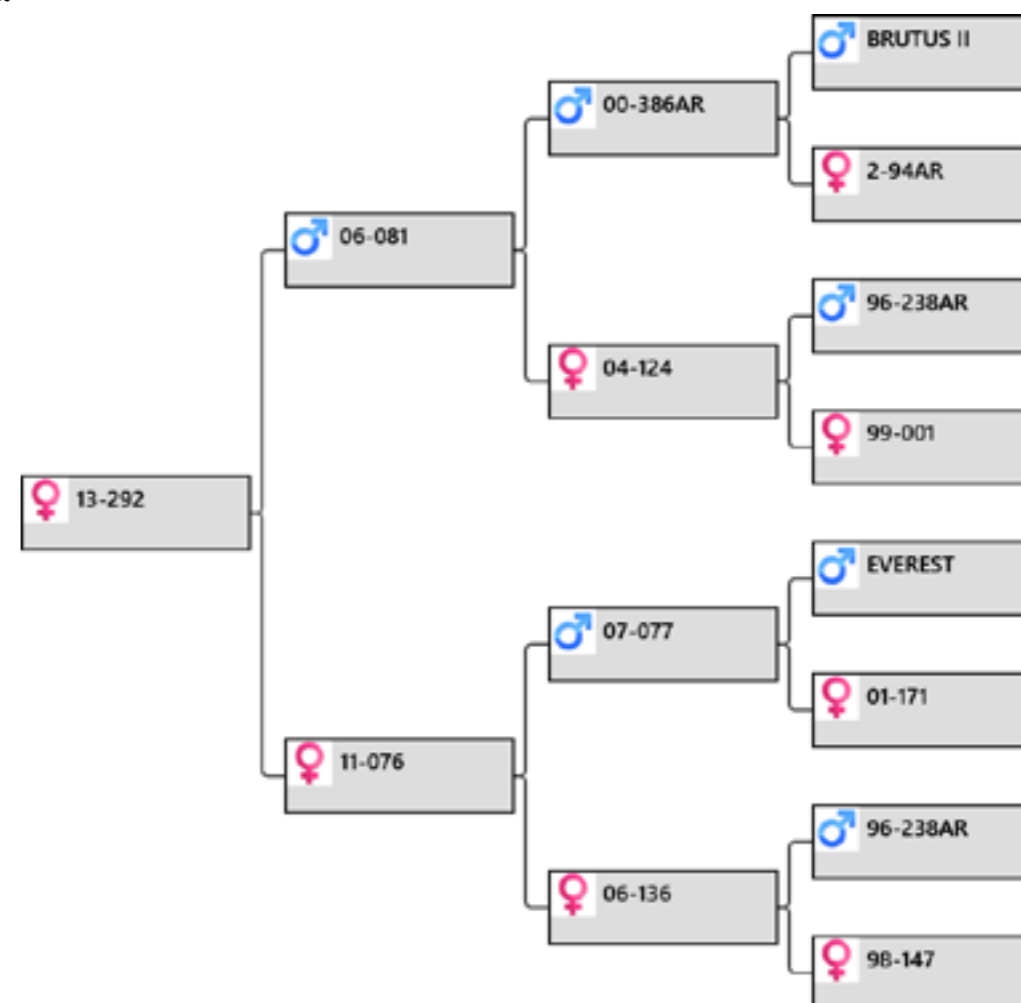

### Biography:

81-06 national 4yr champion over 77-07 2nd national 4yr old competition

Sale weight: Price: Buyer:

## lot # 64 – Yearling hind



performance recorded since 1985

Yearling Hind sale 2015

Animal: **13-294**

Birthdate: 2013

Weigh Date	Weight
30/03/2014	51 kg
30/11/2014	80 kg

### Pedigree:

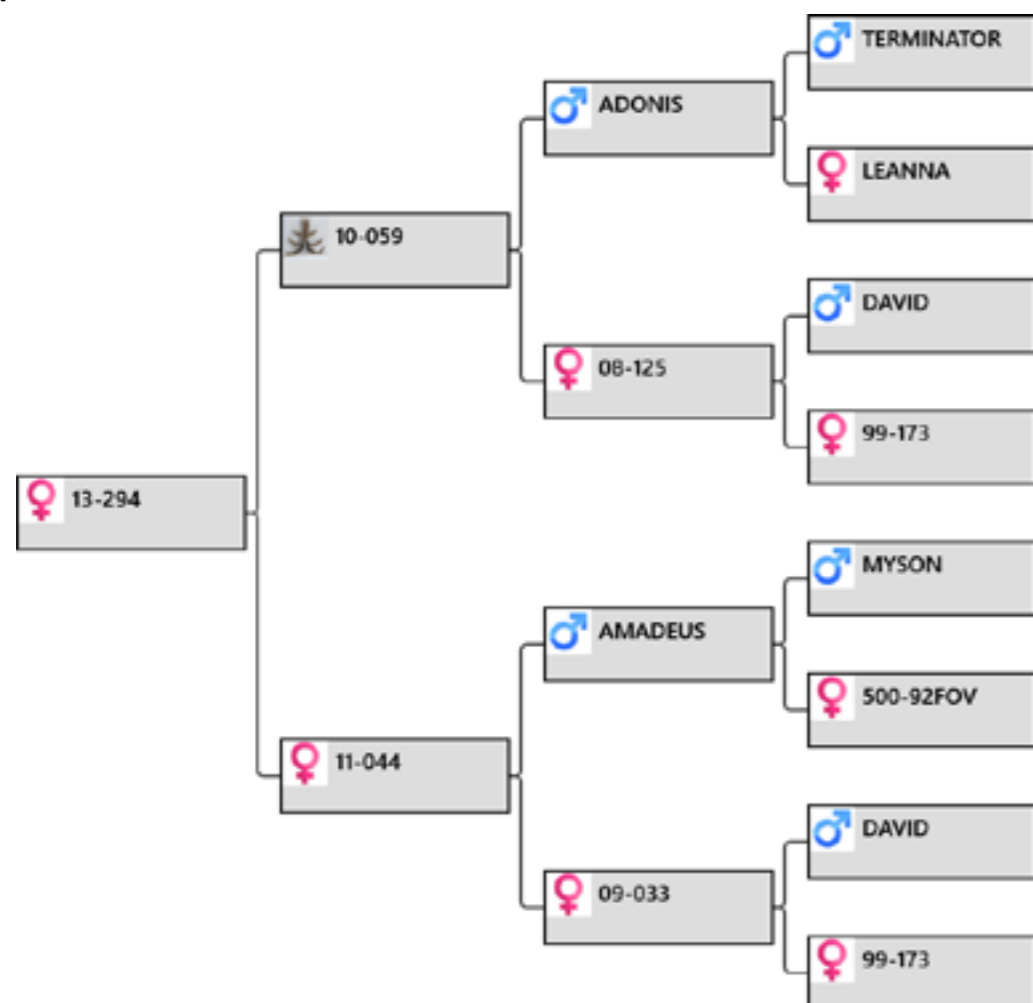

### Biography:

velvet and trophy genetics with 33-09 a full sister to 123-04 502 IOA @ 4yr

Sale weight: Price: Buyer:

## lot # 65 – Yearling hind



performance recorded since 1985

Yearling Hind sale 2015

Animal: **13-297**

Birthdate: 2013

Weigh Date	Weight
30/03/2014	55 kg
30/11/2014	79 kg

### Pedigree:

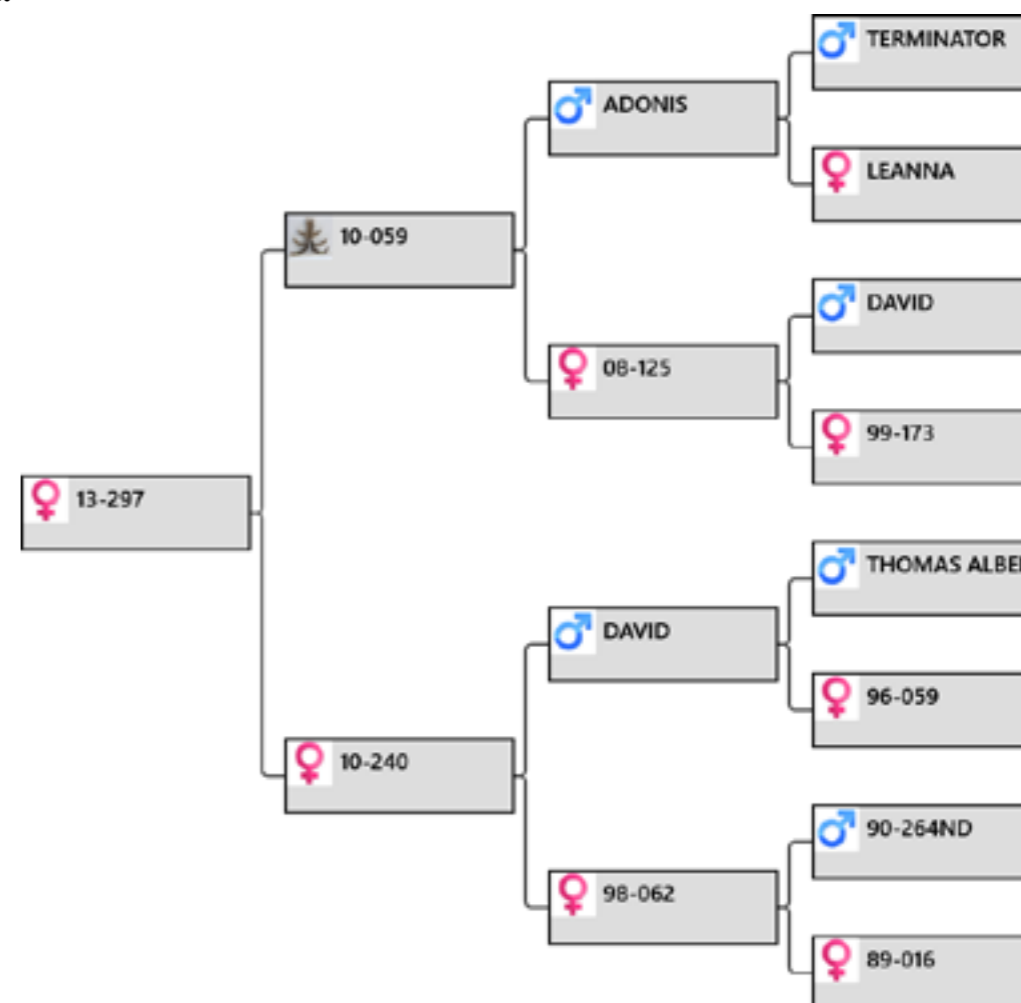

### Biography:

59-10 by Adonis over David daughter with 62-98 and 16-89 both producing trophy stags

Sale weight: Price: Buyer: