

**Altrive
Red Deer**

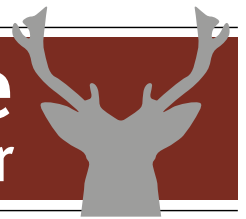

performance recorded since 1985

Geoff Elder

P 03 202 5809 M 0274 365214

www.altrivereddeer.co.nz

2017 Sales Catalogue

6th on-farm DEER SALE

Friday 13th January 2017 5.00pm

sons of Everest – the super sire



188-12 – x Everest
10.35kg SA National 3yr Champion
and 4yr Champion (photo)



105-12 – x Everest
8.2kg SA 2nd place National 3yr
Lot 1 2016



52-13 – x Everest
8.3kg SA 3yr 2nd place Nationals



194-09 – x Everest
7.55kg National Champion



77-07 – x Everest
8.2kg 4yr 2nd place Nationals



95-11 – x Everest
7kg 2yr 3rd place Nationals



welcome

Welcome to our sixth on-farm deer auction.

Lynette and I took over the Family Sheep Farm in 1979 and started performance recording 200 of our commercial ewes which resulted in us selling rams and starting a registered Romney stud as well.

In 1985 we brought our first hinds and so naturally we recorded them too. After five years we were running approximately 200 share farmed hinds, all recorded, as well as our own small herd of around 50 hinds. During the early years we selected on growth rates and then moved on the velvet as well, keeping 2yr old stags that cut a minimum of 1.3kg.

Since 2008 our 2yr old keepers have averaged over 4kg.

This year's 3yr sale average is 6.93kg and the heads are very tidy.

We will also be offering a minimum of 60 2yr velvetting stags.

Photos of velvetting stags should be on our website www.altrivereddeer.co.nz by the New Year.

After the sale you are most welcome to stay for a BBQ and Refreshments.

Geoff Elder

Altrive, 25 Waipounamu Road, RD6,
Gore, Southland

Phone 03 202 5809 Mobile 0274 365214

comp results

A selection of our competition results:

2016

2nd, 4th and 8th Place
National 3yr Velvet Comp
1st and 2nd Place
National 4yr Velvet Comp

2015

1st and 2nd Place
National 3yr Velvet Comp

2012

1st Place Open
National Velvet Comp
People's Choice
National Velvet Comp
Grand Champion
National Velvet Comp
1st Place
National 3yr Velvet Comp
2nd Place
National 5yr Velvet Comp

2011

2nd Place
National 4yr Velvet Comp
3rd and 4th Place
National 5yr Velvet Comp

2010

1st Place
National 2yr Velvet Comp
1st Place
National 4yr Velvet Comp

2009

1st and 3rd Place
National 3yr Velvet Comp
2nd Place
National 2yr Velvet Comp



Altrive 53-07
6.2kg SA 2yr Sold Tower Farms



Altrive 194-09
7.55kg SA 3yr



Altrive 81-06
8.45kg SA 4yr



Zama 74-06
11.3kg SA 6yr



David 11kg SA



Altrive 105-12
8.5kg SA 3yr



Altrive 188-12
10.35kg SA 3yr



Altrive 77-07
8.25kg SA 4yr

statistics

Altrive herd statistics

Herd makeup

We have approx 300 Hinds. All our Stag fawns kept until 2yr olds

Average Velvet Weights

2013 mixed age velvet stags aged 4yr to 11yr averaged **7.25kg**.

Year	2016	2015	2014	2013	2012	2011	2010	2009	2008	2007	2006
2yr Average		3.9kg	3.8kg	3.8kg	3.68kg	3.43kg	3.36kg	3.27kg	3.12kg	3.12kg	2.94kg
2yr Keeper Av		4.54kg	4.48kg	4.3kg	4.36kg	4.14kg	4.20kg	4.25kg	4.05kg	3.83kg	3.60kg
3yr		6.2kg	5.95kg	5.5kg	5.5kg	5.25kg	5.90kg	5.20kg	4.70kg	4.86kg	4.70kg

Approx 55 retained
 Approx 35 retained

Since 2011 we have been keeping a higher number of stags. Although this has lowered the comparative average, the herd continues to go from strength to strength.

2010 Statistics

149 mixed age 4yr and older Stags

19 not suitable for SS grade, double trez or bulbs not good enough average 6.5kg SA

130 stags SS grade average weight 8.6kg

about the sale

6th on-farm deer sale Friday 13th January 2017 5.00pm



188-12 @ 3yr – x Everest

This stag was cut 2 days after this photograph – 10.35kg SA and National 3yr Velvet Champion

26 **3yr and two 4yr Sire Stags** plus approx 70 2yr old **Velveting Stags** and 54 **Yearling Hinds**

Sale offering progeny of:

- **Altrive 81-06**
11.80kg SA @ 7yr
- **Everest 341-04**
12.25kg SA @ 9yr
- **Zama 74-06**
7.60kg SA 3yr Champion
11.30kg Open Champion
- **The Prophet**
Supreme champion 2013
National Velvet Comp.
- **Altrive 123-04**
502 IOA @ 4yr
- **765-10**
8.10kg SA @ 3yr
- **95-11**
8.00kg SA @ 3yr
- **Netherdale 225-11**
7.82kg SA @ 3yr

See sire pages inside for more info.



legal

Conditions of Sale

1. The Sale will be conducted by PGG Wrightson with the conditions of sale as set down by the Stock and Stations Agents Association, a copy of which is exhibited in the office on sale day.
2. Each lot becomes the purchaser's property and risk at fall of the hammer.
3. Warranties and Insurance are covered under separate headings.
4. Terms are strictly cash unless prior arrangements are made with the auctioneers. Accounts not paid within 14 days of sale shall bear interest, at current rate per annum from the date of sale.
5. The sale is conducted exclusive of GST.
6. A buyers commission of 4% is payable to non-participating companies and recognised independent agents introducing and accompanying purchasers to the sale providing prior arrangements [No later than 24hrs prior to sale] are made with PGG Wrightson.
7. Intending purchasers are required to register with the auctioneers prior to the commencement of the sale.
8. No Animals, embryos or semen sold by Altrive, or their germplasm, any subsequent progeny or germplasm, including the semen and germplasm of that progeny may be supplied to a third party without the written permission of the stud.
9. This condition does not affect normal commercial deer farming or stud farming or the normal sales of semen or embryos as it only applies to entities with the primary function of commercial semen/germplasm activities.
10. It is a condition of sale of any animals, embryos, germplasm or semen sold by Altrive that the purchaser agrees to include the following clause as a condition of any subsequent sale or gift of any animal, embryo, semen, germplasm or subsequent progeny or germplasm to a third party- "the purchaser acknowledges that it will not supply any animals, embryos, semen or germplasm to any commercial semen/germplasm marketing or sales entity, and will ensure that this clause is inserted as a condition of any sale or gift of any animals, embryos, semen or germplasm."

Disclaimer

All details and descriptions as to stock referred to in the catalogue have been supplied to PGG Wrightsons by the vendor and have not been independently verified by PGG Wrightson. PGG Wrightson, its employees and agents make no representations or warranties or acknowledgment of any kind whatsoever in relation to any part of this catalogue [including but not limited to accuracy or completeness of details and descriptions of stock {and other contents}]

Purchasers, advisers and all other persons viewing or dealing with the stock must make their own assessment on the stock and the information in this catalogue.

PGG Wrightson, its employees and agents are not responsible or liable in any way whatsoever, weather in contract, tort [including negligence], or otherwise, to any person for any loss or any damage whatsoever arising directly or indirectly from any information or misrepresentation included or omitted from this catalogue.

Velvet will be on display on sale day and will remain the property of the vendor.

Testing

Altrive is TB accredited C10 and all Sires are tested Johnes negative.

Our whole herd is DNA tested.

finding altrive

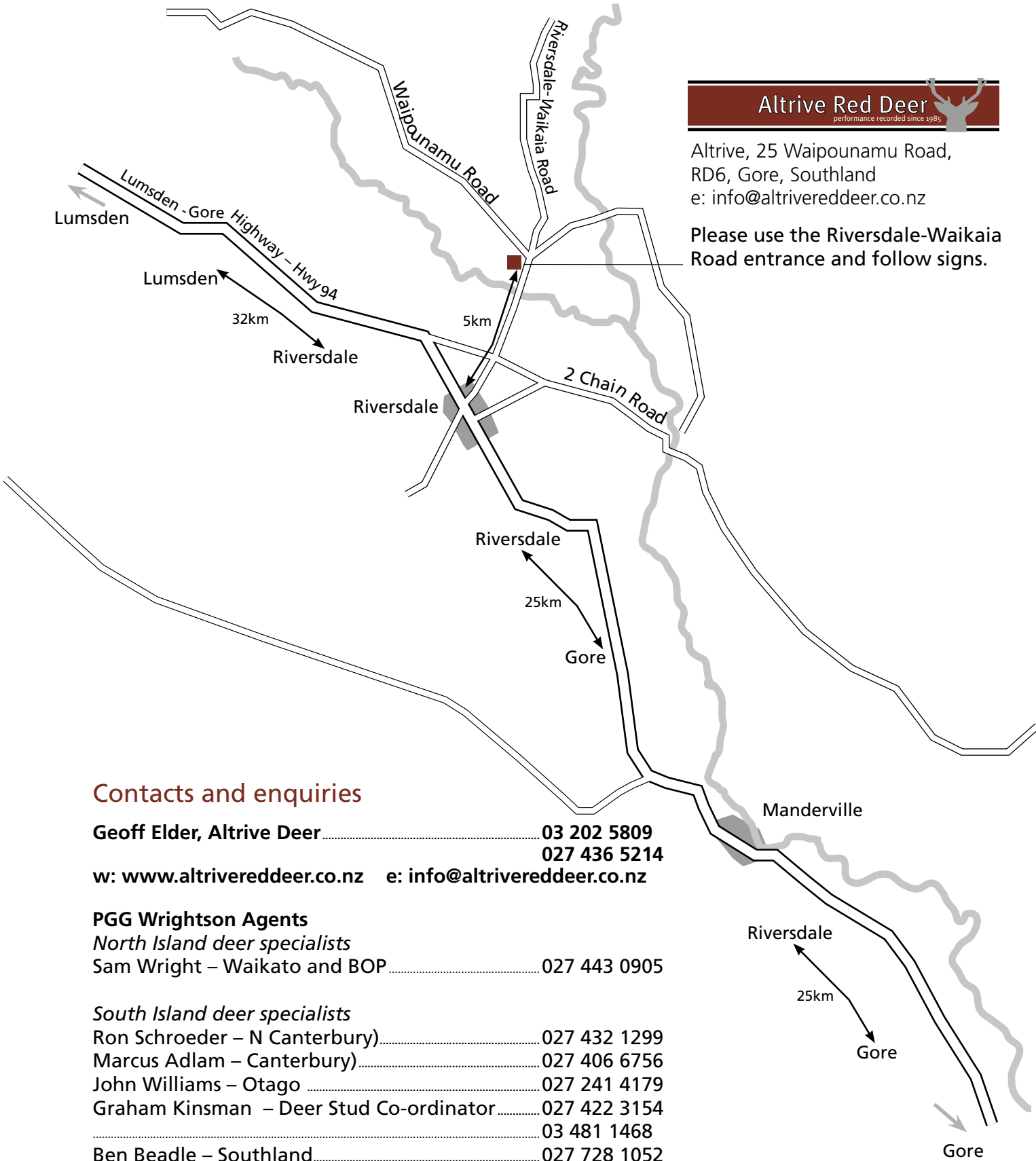

Altrive Red Deer
performance recorded since 1985

Altrive, 25 Waipounamu Road,
RD6, Gore, Southland
e: info@altrivereddeer.co.nz

Please use the Riversdale-Waikaia
Road entrance and follow signs.

Contacts and enquiries

Geoff Elder, Altrive Deer 03 202 5809
027 436 5214
w: www.altrivereddeer.co.nz e: info@altrivereddeer.co.nz

PGG Wrightson Agents

North Island deer specialists

Sam Wright – Waikato and BOP 027 443 0905

South Island deer specialists

Ron Schroeder – N Canterbury) 027 432 1299

Marcus Adlam – Canterbury) 027 406 6756

John Williams – Otago 027 241 4179

Graham Kinsman – Deer Stud Co-ordinator 027 422 3154

..... 03 481 1468

Ben Beadle – Southland 027 728 1052

Auctioneers

John Duffy – Central Otago 027 240 3841

Neville Clark 027 598 6537



sire stags at altrive

Everest 341-04

Everest breeds very heavy tidy velvet that is proven by breeding a 2yr, and two 3yr old National Velvet champions here at Altrive, plus two 2nd and one 3rd place.

Purchased for \$50,000 with Brock Deer.

From his 1st drop in 2007 Everest had 17 stag fawns:

- 9 sold as 2yr velvet stags
- 1 sold as 2yr sire stags
- 7 kept to 3yr sale



9.84kg 5yr. 4th 5yr 2009

Tag# / Name	Everest 341-04
Spiker	
Velvet 2 year	
Velvet 3 year	7.6kg
Velvet 5 year	9.8kg
Velvet 6 year	10.65kg
Velvet 9 year	12.25kg
Notes	Breeding very correct velvet. Everest Sons from first mating: ALT 53-07 6.2kg SA @2yr Sold \$17,000 Tower farms 2yr Champion Won North Island 3yr ALT 61-07 6.0kg SA @ 3yr Sold \$10,500 ALT 76-07 6.6kg SA @ 3yr Sold \$10,500 ALT 59-07 5.9kg SA @ 3yr Sold \$6500 ALT 77-07 7.46kg SA Retained in stud 8.24kg 4yr 2nd place Nationals

Progeny of Everest 341-04



188-12 10.35kg @ 3yr 105-12 8.2kg 3yr 53-07 6.2kg 2yr



194-09 7.55kg Champ 77-07 8.24kg sa 4yr 95-11 7kg 2yr



76-07 6.6kg sa 3yr 61-07 6.0kg sa 3yr 59-07 5.9kg sa 3yr



123-07 6.04kg sa 3yr 194-09 5.0kg 2yr 91-09 4.5kg 2yr



84-09 5.2kg 2yr 103-11 7.25kg @ 3yr 65-11 6.3kg @ 3yr



23-12 4.6kg 2yr

Pedigree

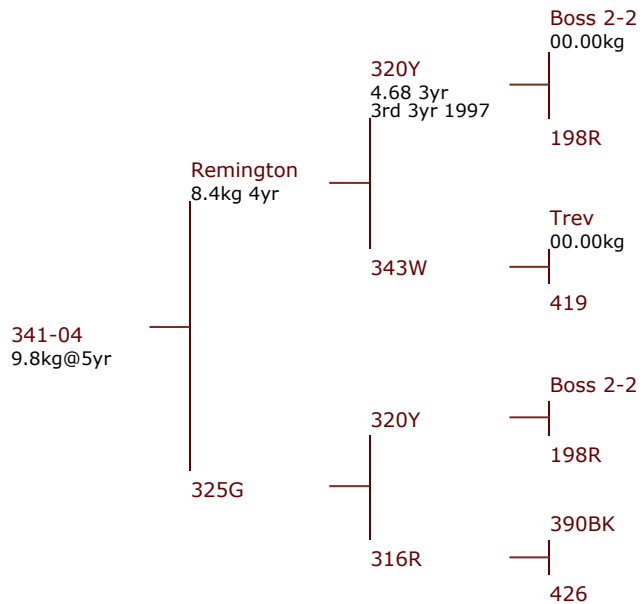

Zama 74-06

Zama was purchased for \$30,000. He is jointly owned with Brock Deer. (Now deceased.)



74-06 11.3kg Winner of National Open, Grand Champion and People's Choice, 2012 at 6yr

Tag# / Name	74-06 / Zama
Weaner weight	
Velvet 3 year	7.66kg 3 yr Won National 3 yr velvet competition
Velvet 4 year	Grown out 4 yr 422 IOA
Velvet 5 year	Grown out 5 yr 478 IOA
Velvet 6 year	11.3kg Winner of National Open, Grand Champion and People's Choice, 2012
Velvet 7 year	12.25kg
Notes	First 2 yr sons born 2009 averaged 4kg



2009 Nationals



2 yr head 30 point ha



Zama - growing out 2011

Pedigree

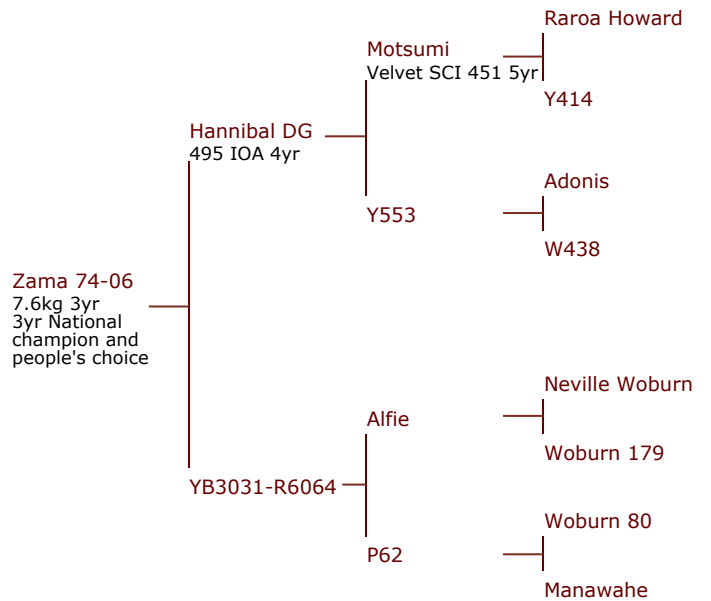

See next page for progeny of Zama



Progeny of Zama 74-06



142-09 4.65kg 2yr



Victrix in velvet @ 6yr



Victrix as trophy @ 6yr

Victrix (142-09) was sold to Arawata stud at our 2012 sale.



34-12 7.35kg @3yr



46-12 7.2kg 3yr



171-11 6.65kg 3yr



26-10 6.2kg 3yr



161-11 @ 2yr



21-13 5.05kg @ 2yr



89-13 2yr Cut 8.3kg



38-13 6.45kg @ 2yr



111-09



111-09 4.6kg 2yr



76-09 6kg 2yr



10-09 4.35kg 2yr



101-09 4.65kg 2yr



106-10 4.6kg 2yr



108-10 5.15kg 2yr



171-11 6.65kg 3yr



199-11 7.65kg 3yr



159-11 6.35kg 3yr



173-11 6.0kg 3yr



167-11 6.5kg 3yr



18-12 4.85kg 2yr



34-12 5kg 2yr



173-12 5kg 2yr

David 230-98

David cut 11kg @9yr and sired 123-04 502 IOA @4yr.

Also sired 186-04 sold as sire to Alan Stewart \$20000.

Has left 3yr olds cutting up to 8kg of velvet.



Full head of David x Thomas Albert



David - 11kg 6th Open 2009

Progeny of David 230-98



186-04



David + Son 123-04



113-07 tw 6.52kg sa 3yr



99-10 5.7kg 2yr



99-10 Spiker



99-10 Spiker



99-10 Spiker 6.1kg



133-11 6.15kg 3yr



46-11 9.1kg 3yr



149-10 6.4kg @ 3yr

Tag# / Name	230-98 / David
Weaner weight	
Velvet 2 year	
Velvet 11 year	11kg sa
Notes	

Pedigree

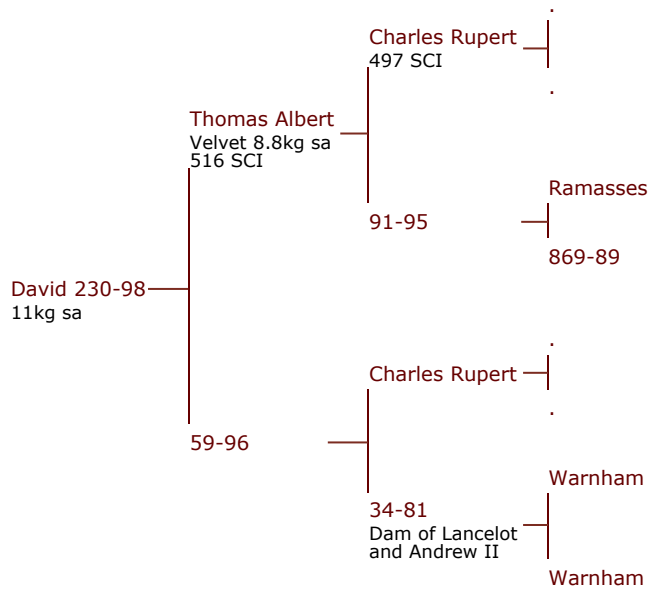



Contact us Today...

Altrive 81-06

Tag# / Name	81-06
Weaner weight	79kg
Velvet 2 year	5.7kg 2nd National 2yr velvet Competition
Velvet 3 year	7.3kg
Velvet 4 year	8.45 kg 4 yr 4 yr National velvet champ First 2 yr sons velveteed Dec 2011
Velvet 5 year	
Velvet 6 year	11.0kg
Velvet 7 year	11.8kg
Velvet 9 year	17.2kg SS
Notes	



81-06 8.45kg sa 4yr 2nd National 2yr competition Winner National 4yr Competition



103-08 5.6kg sa 2yr. Full brother of 81-06

Progeny of 81-06

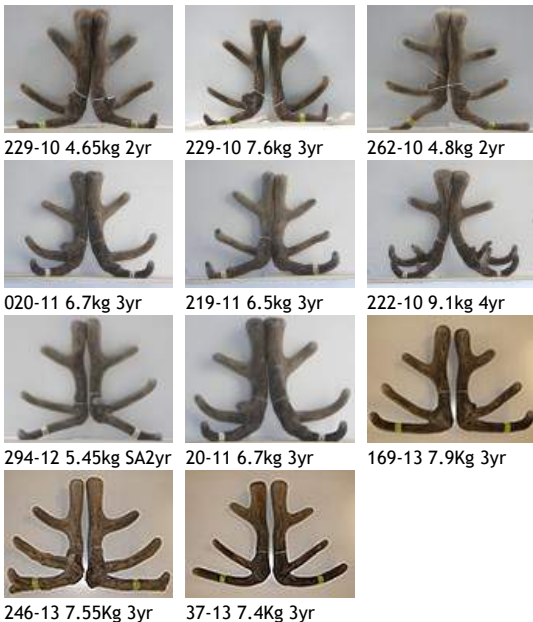

Pedigree

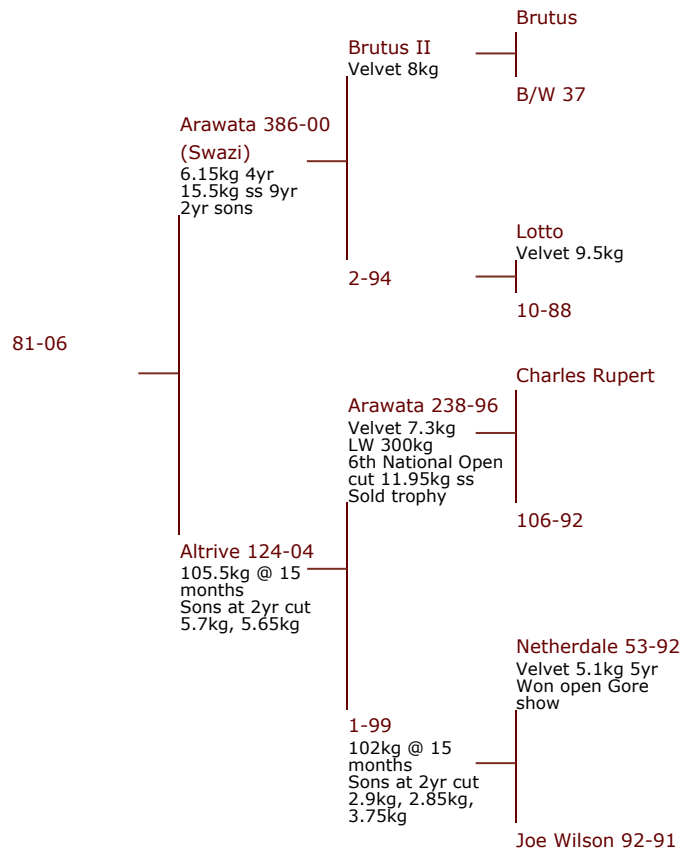

Altrive 77-07

Sold to Regan Blair for \$15,000 to make way for Everest son 95-11 7kg 2yr.



Altrive 77-07 - 8.24kg sa 4yr - 2nd place Nationals 2011 x Everest.
10kg @ 6 yr

Tag# / Name	77-07
Weaner weight	
Velvet 2 year	4.35kg
Velvet 3 year	7.46kg
Velvet 6 year	10.00kg
Notes	Very strong Dam line for velvet. Check out other Everest sons on Everest page.

Progeny of 77-07



255-11 5.6kg @ 3yr 150-12 7.20g @ 3yr 169-12 6.40kg @ 3yr



277-12 6.8kg @ 3yr 150-12 5.45kg @ 2yr 77-11 6.7kg @ 3yr

Pedigree

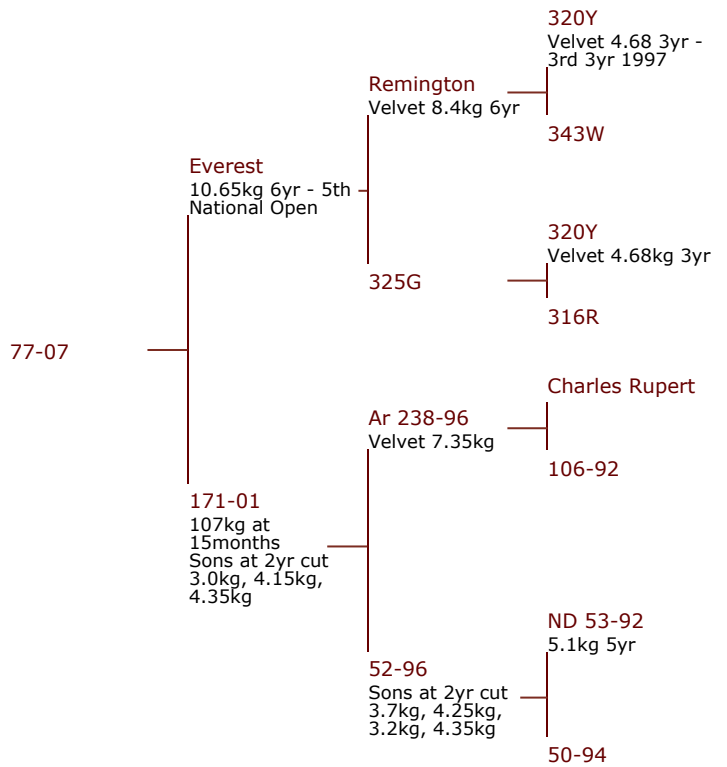



Arawata Swazi 386-00

Purchased for \$30,000 with Brock Deer and E Tayles

Swazi's complete drop of 2 yr sons had an average weight of 3.51kg in 2007 and 3.72kg in 2008.



Altrive sire stag - Arawata Swazi 386-00. 14.3kg SS 8yr.



5.2kg 3yr

Progeny of 386-00



81-06 8.45kg sa 4yr 103-08 5.65kg sa 2yr 20-06 7.3kg 3yr

Tag# / Name	386-00 Arawata Swazi
Weaner weight	
Velvet 3 year	5.2kg
Velvet 4 year	6.0kg
Velvet 9 year	15.5kg SS
Notes	Very good Sire that mated well with all Dam lines

Pedigree

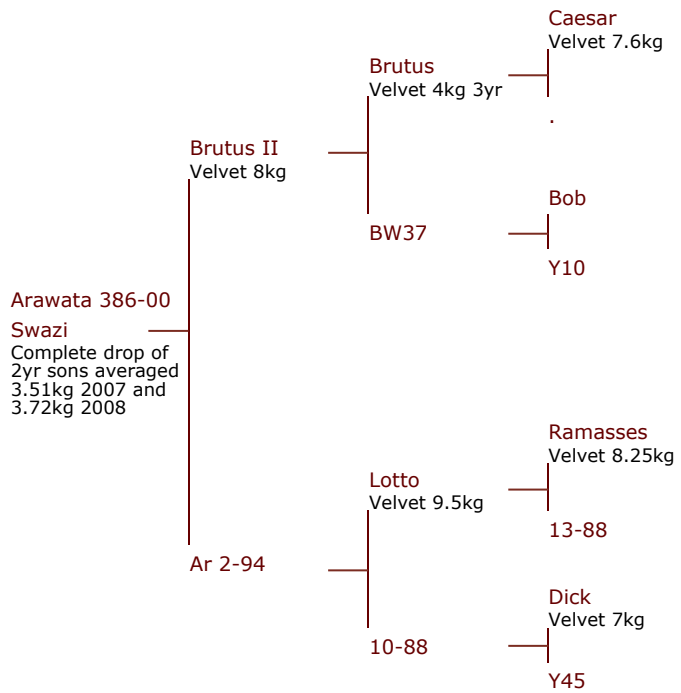

Altrive 123-04

Trophy 2yr son sold for \$12000 and breeds good velvet with 3yr sons over 7kg.

4.2 kg SA 2 yr 3rd Southland 2 yr competition

5.2 kg SA 3 yr

Scored 502 IOA @ 4yr and breeds very good velvet and trophy heads as can be seen in the progeny photos below.



123-04



4.2 kg SA 2 yr

Progeny of 123-04



196-07 7.3kg sa 3yr 162-07 5.95kg sa 3yr 242-09 Spiker



56-10 4.6kg 2yr 171-10 4.45kg 2yr 41-10 Trophy@2yr



243-09 10.55kg 243-09 10.55kg 243-09 6.55kg cut 1.11

Tag# / Name	123-04 David Son (deceased)
Weaner weight	62kg
2 year	200kg
Velvet weight 2yr	4.2kg
Notes	Now deceased

Pedigree

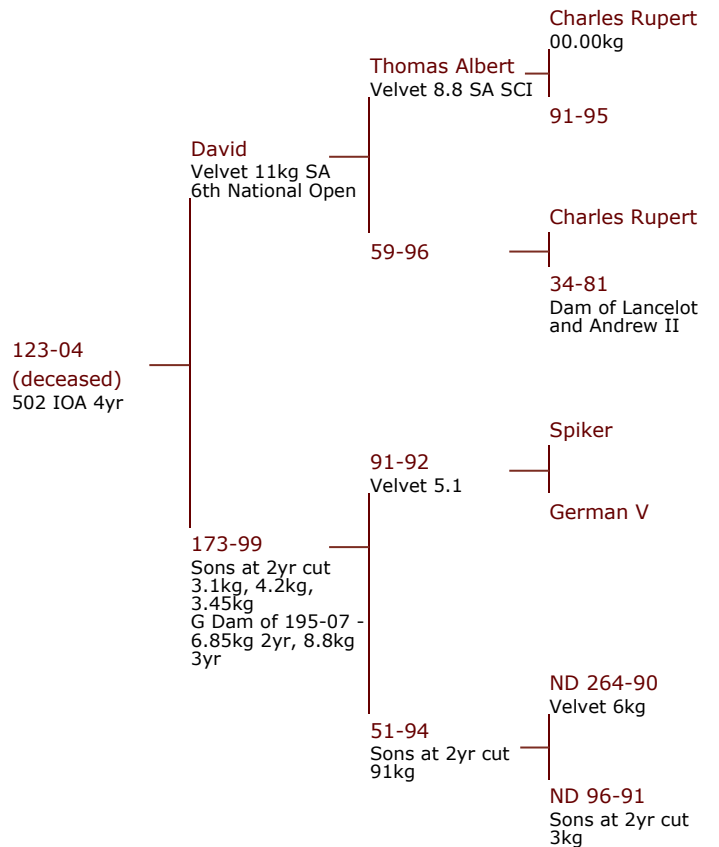



Arawata 238-96 - Altrive sire stag

238-96 cut 7.35kg 7yr and bred very well for us with a lot of his sons sold as trophy stags and his daughters breed well.

Pedigree

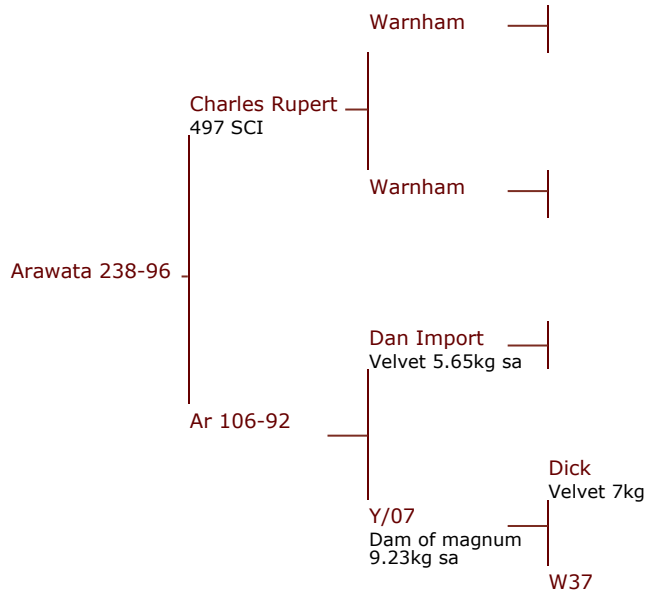

7.35kg SA 7 yr 11.95kg SS 8 yr 300kg Live weight



7.35kg 7yr (6th Nat Open)

Progeny of 238-96



78-02 10kg ss 6yr 78-02 485 sci 78-02 7.65 5yr 47-04 10.2kg ss 261-03 10.25kg ss 136-03 6.8kg 4yr 4 Sons of 238-96

Altrive 78-02



7.65 5yr



10kg ss 6yr / 11.65kg ss 7yr

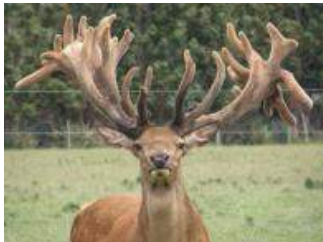

Full head 78-02 Dec 2010
485 SCI

Progeny of 78-02



82-06 7.36kg 3yr



224-10 4.55kg 2yr

Tag# / Name	78-02
Weaner weight	
Velvet 3 year	5.15kg SA
Velvet 4 year	6.5kg SA
Velvet 5 year	7.65kg SA
Velvet 9 year	11.65kg SA
Notes	Son of 238-96

Pedigree

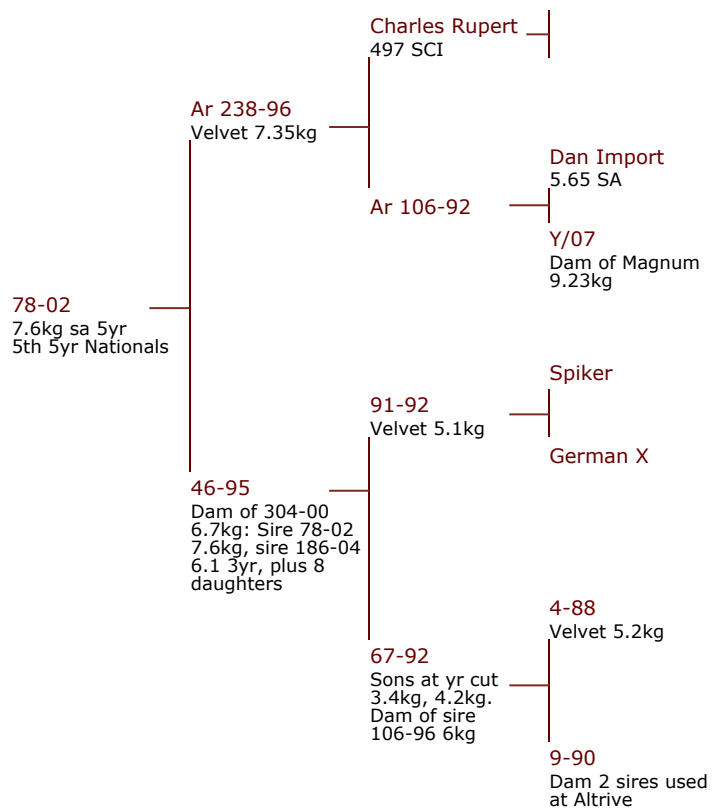



Altrive 186-04



Altrive 186-04 Sire Stag

Progeny of 186-04



195-07 8.8kg sa 3yr

Tag# / Name	186-04
Weaner weight	
Velvet 2 year	4.85kg SA
Velvet 3 year	6.1kg SA
Velvet 4 year	10kg SS
Notes	Only used as two year old

Pedigree

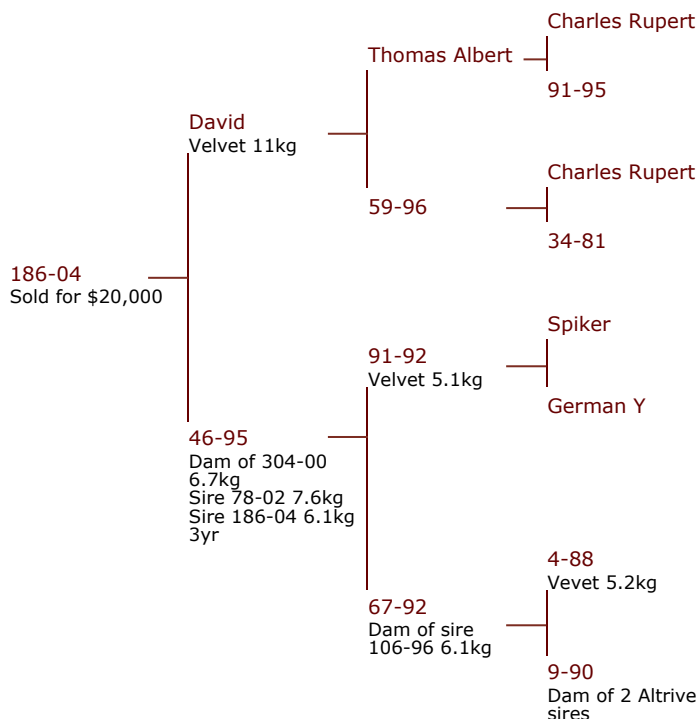

Gloriavale 352-08

Spiker 20 point 300plus IOA. Only used as a 2yr old.



Photo of 352-08 10.8kg @ 7yr

Tag# / Name	352-08
Weaner weight	
2 year live weight	174kg
Velvet 2 year	Full head
Notes	

Progeny of 352-08



242-11 6.7kg 3yr

258-11 8.5kg 3yr

Pedigree

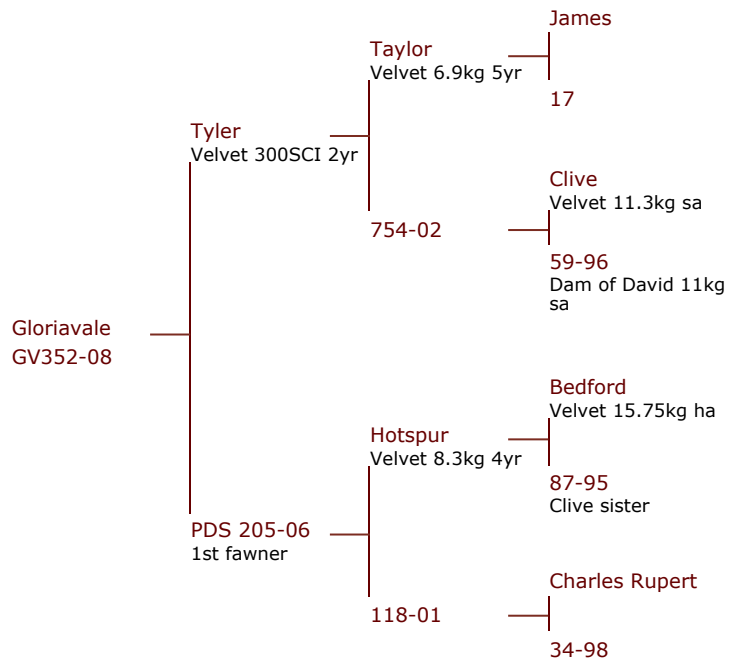



FOV 191-09

This stag was purchased in 2012 as a 2yr old from Foveran. An Amadeus son with very correct head weighing 10kg HA. Bought to add trophy tops to our stags.

3yr head looking very good.



191-09 grown out @ 3 years

Tag# / Name	FOV 191-09
Spiker	
Velvet 2 year	10kg HA
Velvet 3 year	
Velvet 5 year	
Velvet 6 year	
Notes	Weaned weight 66kg, 200kg @ 2yr. Grown out at 3 yr.

Progeny of FOV 191-09



216-12 7.4kg @ 3yr



219-12 6.1kg @ 3yr



249-12 6.05kg @ 3yr



216-12 5.75kg @ 2yr

Pedigree

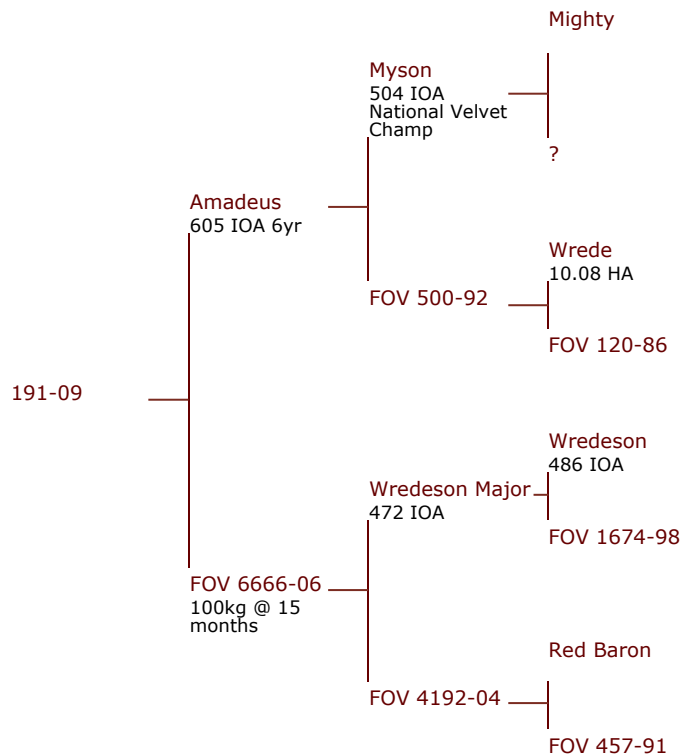

Altrive 95-11

First two year progeny to be velveted in 2016.



95-11 7.0kg @ 2yr



95-11 8.6kg @ 3yr

Tag# / Name	Altrive 95-11
Weaner weight	
Velvet 2 year	7.0kg
Velvet 3 year	8.6kg
Velvet 4 year	
Velvet 5 year	
Velvet 6 year	
Velvet 7 year	
Notes	

Pedigree

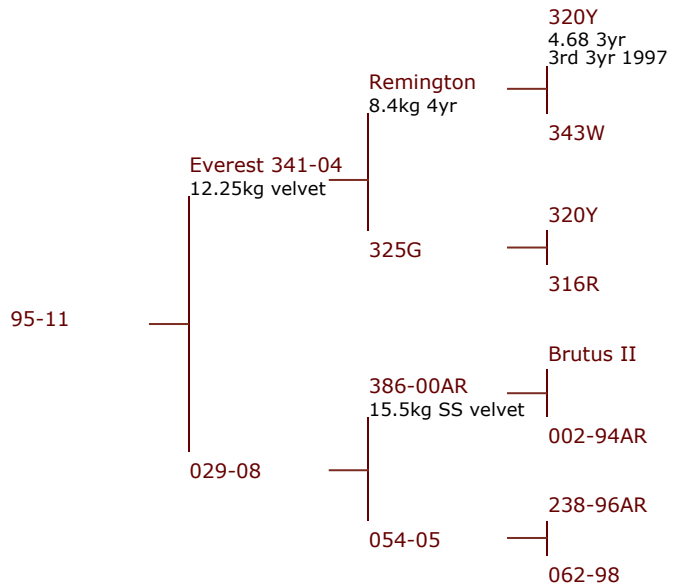



The Prophet

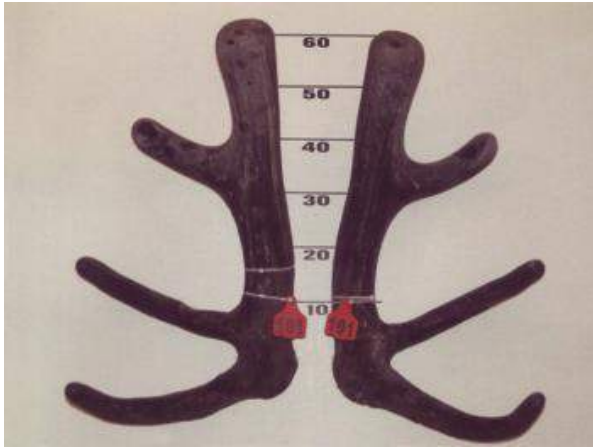

The Prophet 10.54Kg SA@9yr
Supreme champion 2013 National Velvet Competition.

Progeny of The Prophet

We have no photos of progeny by The Propeht yet.

Tag# / Name	The Prophet
Weaner weight	
Velvet 2 year	
Velvet 3 year	
Velvet 4 year	
Velvet 5 year	
Velvet 6 year	
Velvet 7 year	
Velvet 9 year	10.54kg SA
Notes	

Pedigree

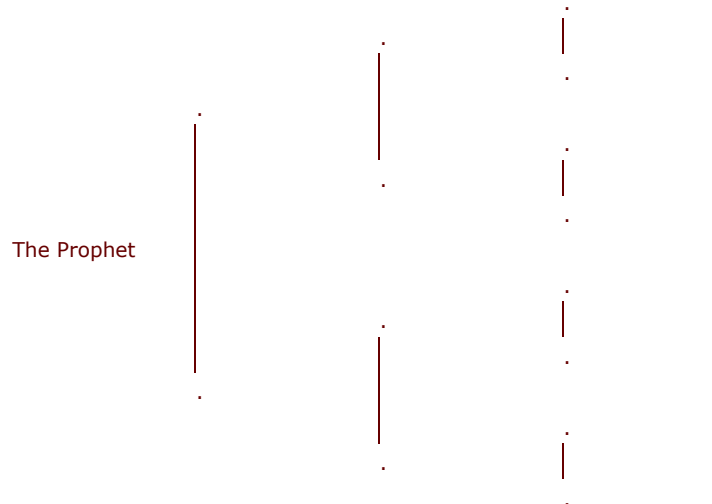

Netherdale 225-11

A recent addition to the Altrive stud and shared with Arawata.



Netherdale 225-11 - 7.82kg SA @3yr

Progeny of Netherdale 225-11

We have no photos of 225's progeny yet.

Tag# / Name	Netherdale 225-11
Weaner weight	
Velvet 2 year	4.5kg
Velvet 3 year	7.82kg
Velvet 4 year	9.00kg
Notes	Purchased with Arawata stud for \$40,000. Was L 1 at the 2015 Netherdale sale.

Pedigree

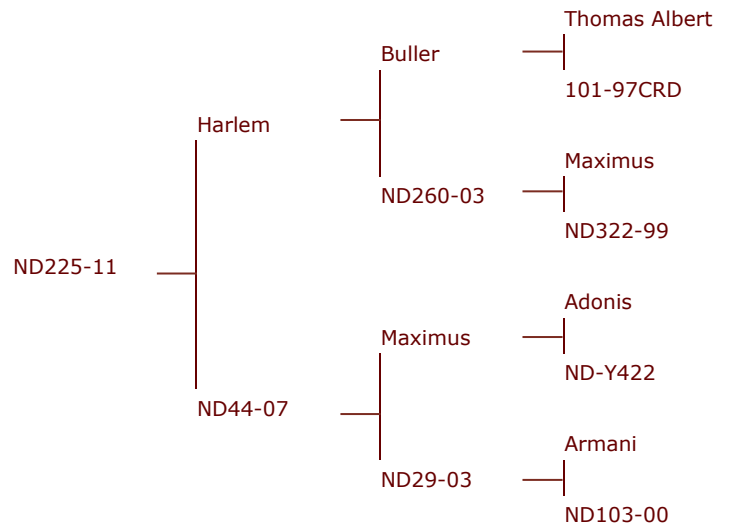



765-10

765-10 has first 2yr olds this year and is breeding well with his best 2yr old son as at 4/12/15 cutting 5.8kg and only one under 4kg from the 8 cut to date.



765-10 11.8kg SS @ 5yr

Progeny of 765-10

We have no photos of 765-10's progeny at present.

Tag# / Name	765-10DDF
Weaner weight	
Velvet 2 year	7.8kg SA
Velvet 3 year	8.1kg SA
Velvet 4 year	10.74kg SS
Velvet 5 year	11.8kg SS
Velvet 6 year	
Velvet 7 year	
Notes	

Pedigree

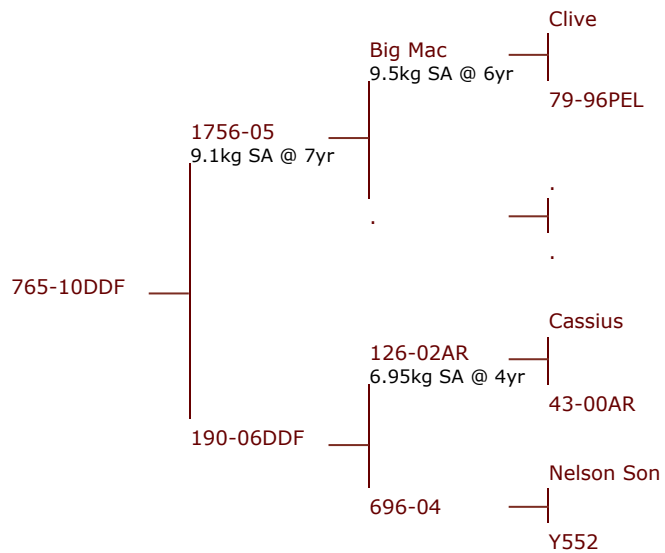

lot # 1 – 3yr sire stag



Animal: **13-052**

Birthdate: 2013

Weigh Date	Weight
30/03/2014	71 kg

Velvet Date	Weight	Grade
1/12/2016	8.30	
1/12/2015	6.00	

3yr Velvet weight 8.3kg

Pedigree:

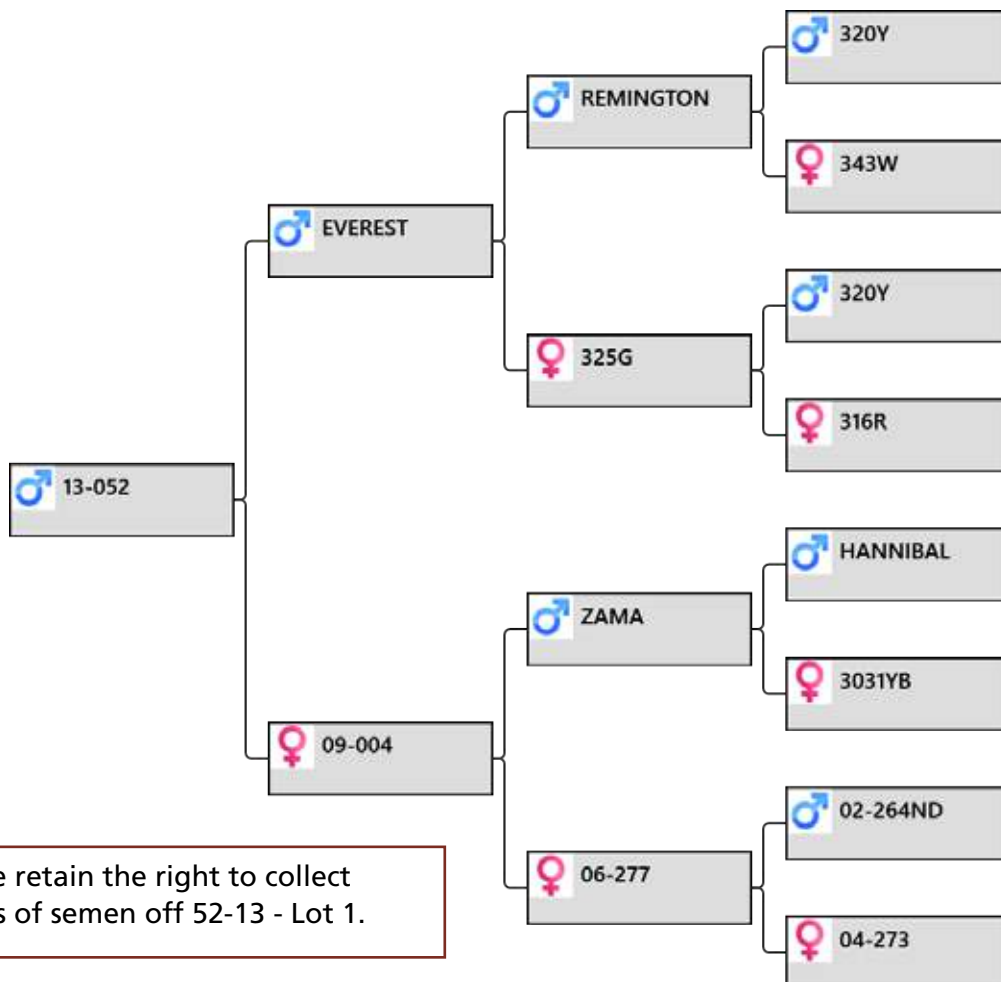

Note: We retain the right to collect 15 straws of semen off 52-13 - Lot 1.

Biography:

52-13 another very quiet Everest son with the most correct heavy head of velvet we have bred. Placed 2nd at the nationals. 4-09 4 daughters plus this stag.

277-06 a son sold 2014 plus sons cutting 4.0, 4.55 and a Zama son this yr @ 4.6kg @ 2yr Grand dam of 273-04 was 52-96 with sons cutting 4.35 and 4.25 @ 2yr with 1 used in stud, she was also G dam of 77-07 10 kg 6yr. LW 13/12/16 214kg

2nd Place Nationals 2016.

Sale weight:

Price:

Buyer:



lot # 2 – 3yr sire stag



Animal: **13-169**

Birthdate: 2013

Weigh Date	Weight
30/03/2014	65 kg

Velvet Date	Weight	Grade
1/12/2016	7.90	
1/12/2015	5.30	

3yr Velvet weight: 7.90kg

Pedigree:

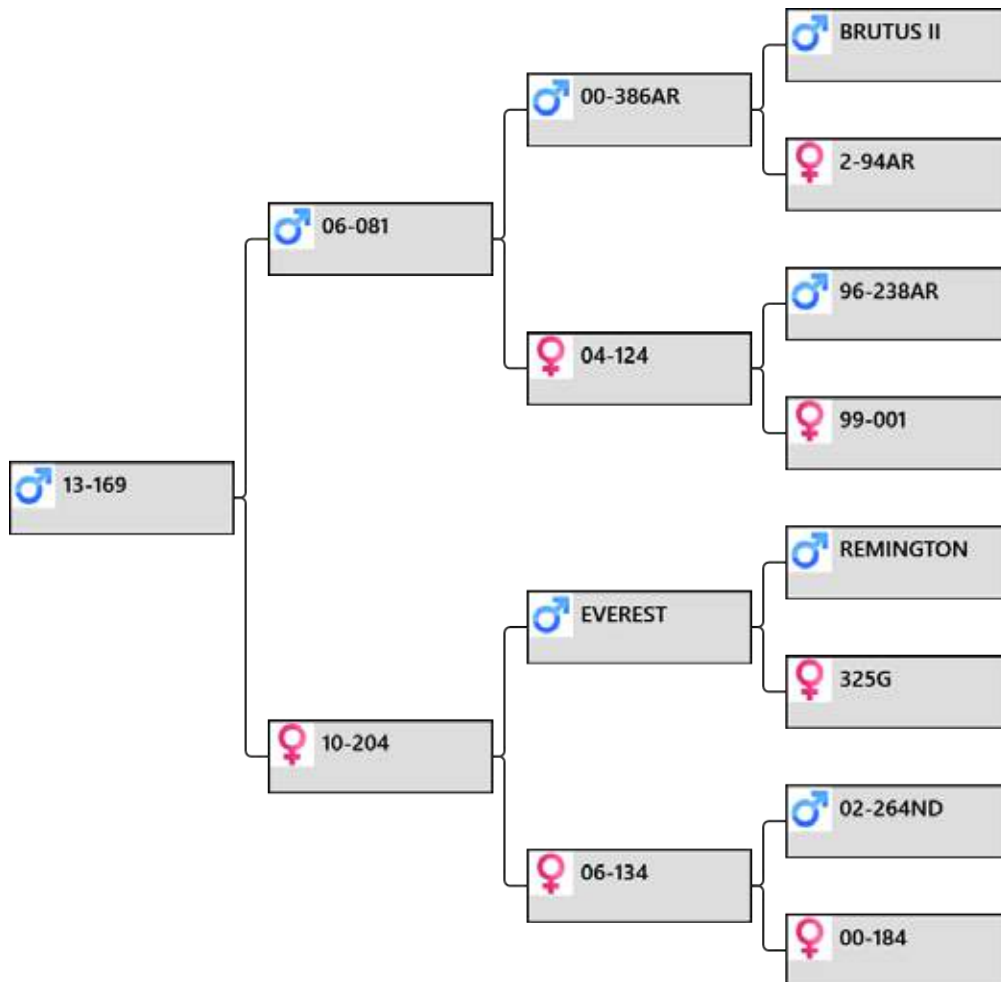

Biography:

169-13 has a very good clean head of velvet. His coronets are 30 cm. 8th place nationals.
 204-10 is an Everest daughter and also has a daughter and a spiker.
 134-06 is by ND 264 -92 4th 3yr old Nationals 2005. He is in lot 1 pedigree too.
 184-00 sons sold 2013 \$9,500 and 2014 \$6,500
 LW 13/12/16 194.5kg

Sale weight:

Price:

Buyer:

lot # 3 – 3yr sire stag



Animal: **13-037**

Birthdate: 2013

Weigh Date	Weight
30/03/2014	61 kg

Velvet Date	Weight	Grade
1/12/2016	7.40	
1/12/2015	4.50	

3yr Velvet weight: 7.4kg

Pedigree:

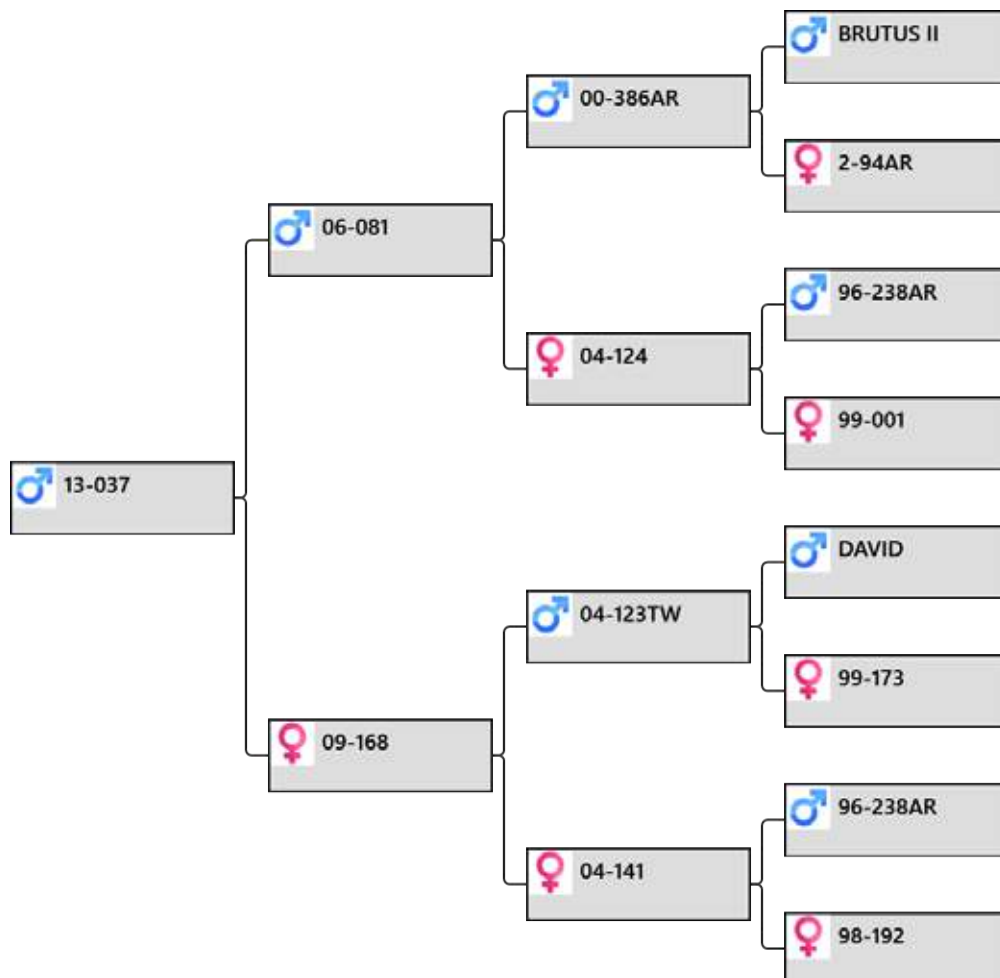

Biography:

Very clean and correct velvet off a very quiet stag.

168-09 a very good hind and dam of lot 11 2015 7.65kg of velvet \$9,500

141-09 dam of lot one 2014 \$20,000. A very strong dam line.

LW 13/12/16 223kg

Sale weight:

Price:

Buyer:



lot # 4 – 3yr sire stag



Animal: **13-078**

Birthdate: 2013

Weigh Date	Weight
30/03/2014	61 kg

Velvet Date	Weight	Grade
1/12/2016	7.30	
1/12/2015	4.65	

3yr Velvet weight: 7.3kg

Pedigree:

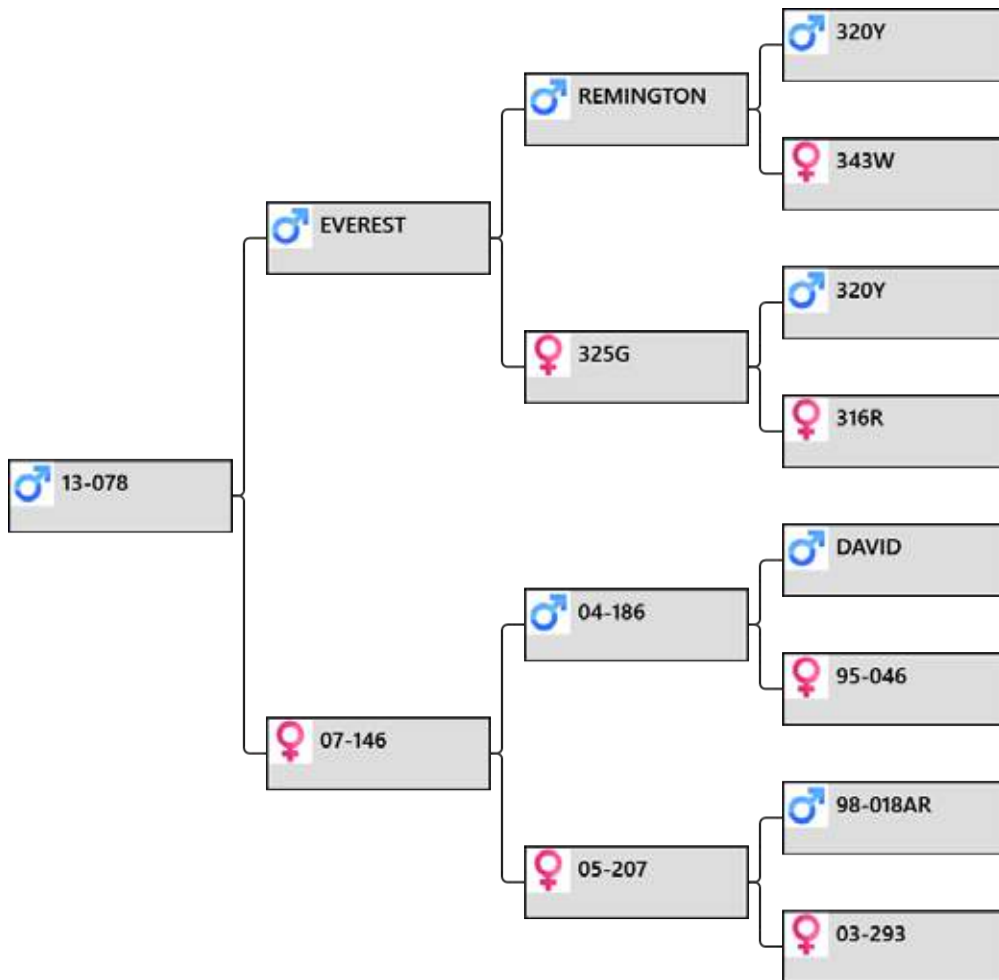

Biography:

Another Everest son with an extremely tidy head

146-07 is by 186-04 out of our top dam line with 46-95 2 sons used in stud and she is Grand dam of Victrix and lot 10 last year.

LW 13/12/16 193kg

Sale weight:

Price:

Buyer:

lot # 5 – 3yr sire stag



Animal: **13-246**

Birthdate: 2013

Weigh Date	Weight
30/03/2014	64 kg

Velvet Date	Weight	Grade
1/12/2016	7.55	
1/12/2015	5.80	

3yr Velvet weight: 7.55kg

Pedigree:

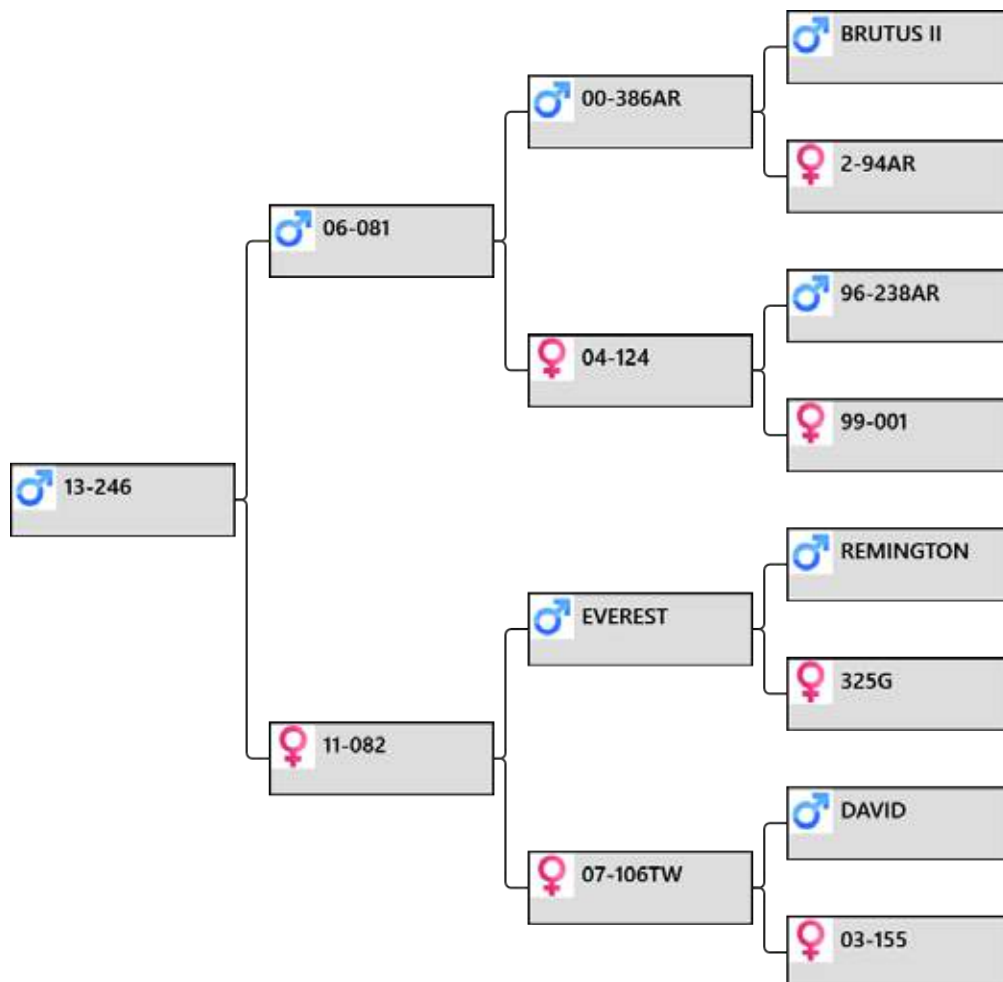

Biography:

Another very good head of velvet off another 81-06 son. 81-06 11.7kg SA and a massive 18.4kg SS @ 10yr. 82-11 by Everest and she is a first fawner
 106-07 has a daughter with a son by 81-06 sold 2015
 155-03 sons sold 2013 and 2014 and she is out of 46-95 mentioned in previous lot.
 LW 13/12/16 209kg

Sale weight:

Price:

Buyer:



lot # 6 – 3yr sire stag



Animal: **13-271**

Birthdate: 2013

Weigh Date	Weight
30/03/2014	57 kg

Velvet Date	Weight	Grade
1/12/2016	8.65	
1/12/2015	6.00	

3yr Velvet weight: 8.65kg

Pedigree:

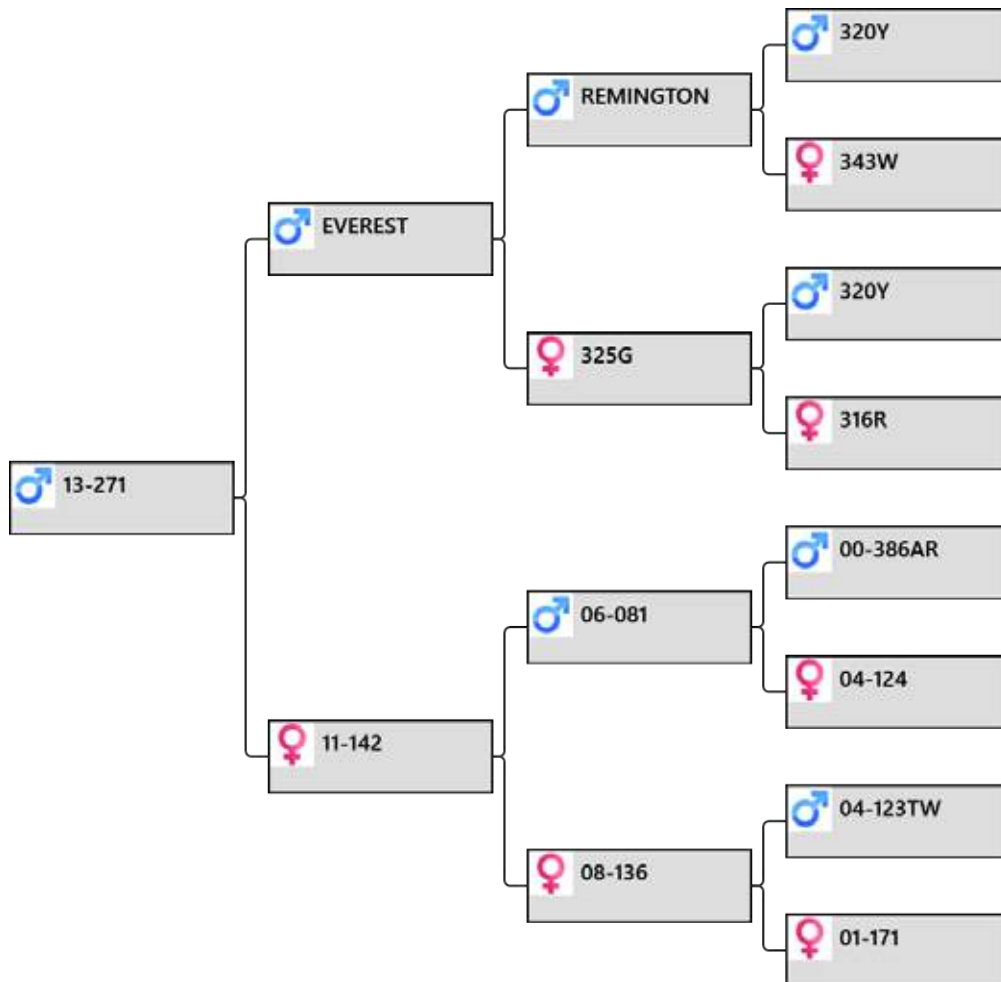

Biography:

A very big head of velvet off this Everest son.

142-11 just a first fawner 81-06 daughter

136-08 is out of 171-01 the dam of 77-07 10kg @6yr and a son sold 2014.

52-96 the dam of 171-01 also had a son used in the stud.

LW 13/12/16 211kg

Sale weight:

Price:

Buyer:

lot # 7 – 3yr sire stag



Animal: **13-091**

Birthdate: 2013

Weigh Date	Weight
30/03/2014	70 kg

Velvet Date	Weight	Grade
1/12/2016	8.40	
1/12/2015	4.50	

3yr Velvet weight: 8.40kg

Pedigree:

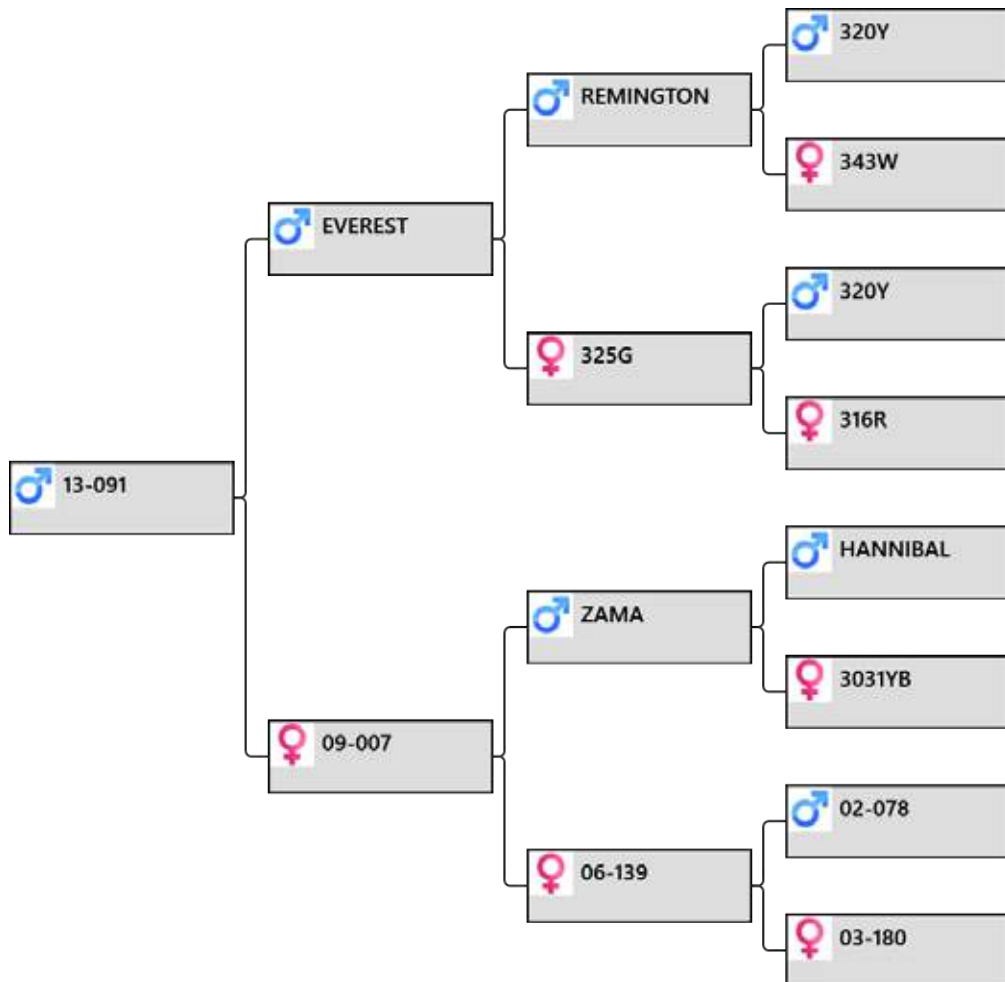

Biography:

This stag has potential to grow a huge head as can be seen in the photo tops are dimpled but trezs still a lot of growing to do.

7-09 by Zama 12.25kg and supreme champion.

139-06 son sold 20-09 2013 \$5,000

180-03 sons sold 2012 \$4,500 and 2013 \$3,500. LW 13/12/16 205kg

Sale weight:

Price:

Buyer:



lot # 8 – 3yr sire stag



Animal: **13-082**

Birthdate: 2013

Weigh Date	Weight
30/03/2014	64 kg

Velvet Date	Weight	Grade
1/12/2016	7.70kg	
1/12/2015	4.65	

3yr Velvet weight: 7.70kg

Pedigree:

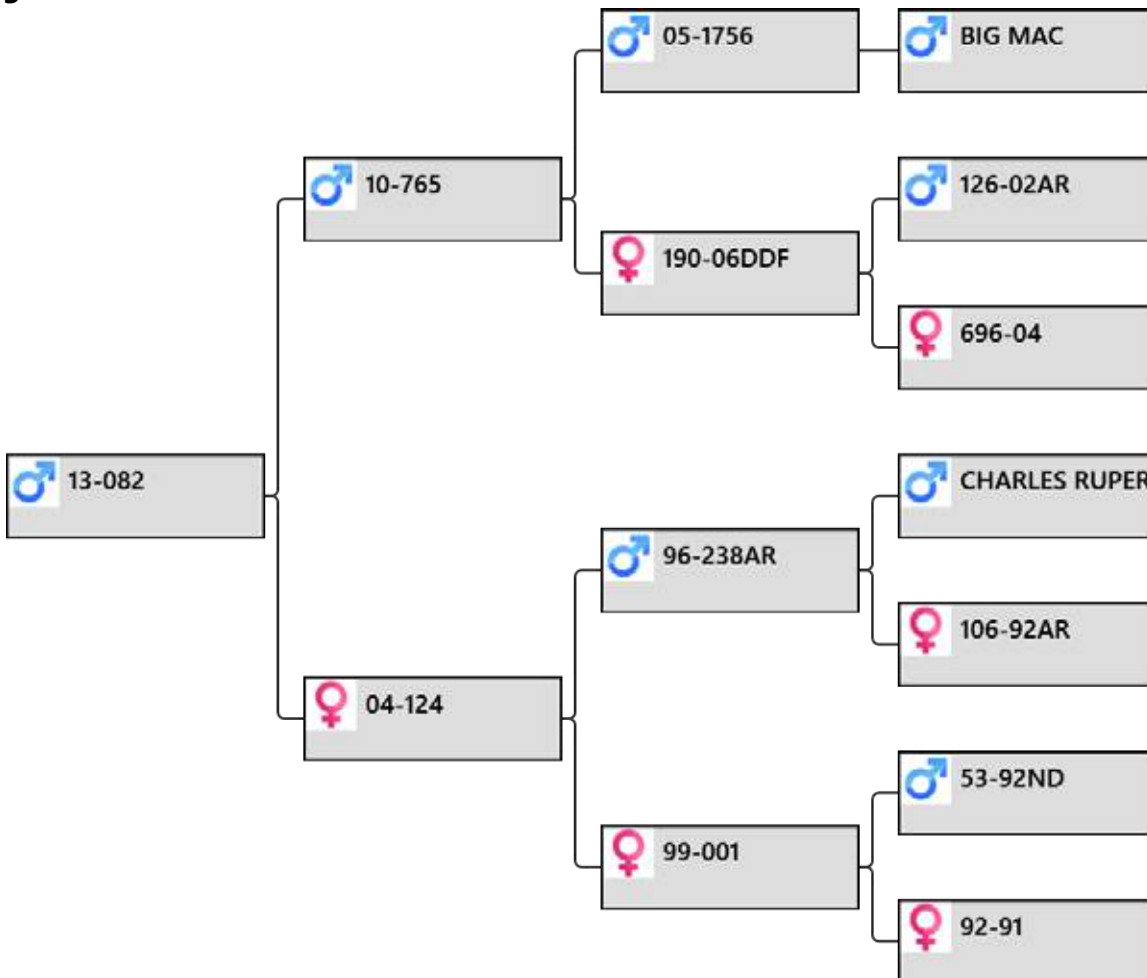

Biography:

Big weight and huge bulbs on the velvet off this stag out of 124-04 who is the dam of 81-06 11.8kg SA @ 7yr and 18.4kg SS. @ 10yr. LW 13/12/16 227kg

Sale weight:

Price:

Buyer:

lot # 9 – 3yr sire stag



Animal: **13-038**

Birthdate: 2013

Weigh Date	Weight
30/03/2014	71 kg

Velvet Date	Weight	Grade
1/12/2016	7.85	
1/12/2015	6.45	

3yr Velvet weight: 7.85kg

Pedigree:

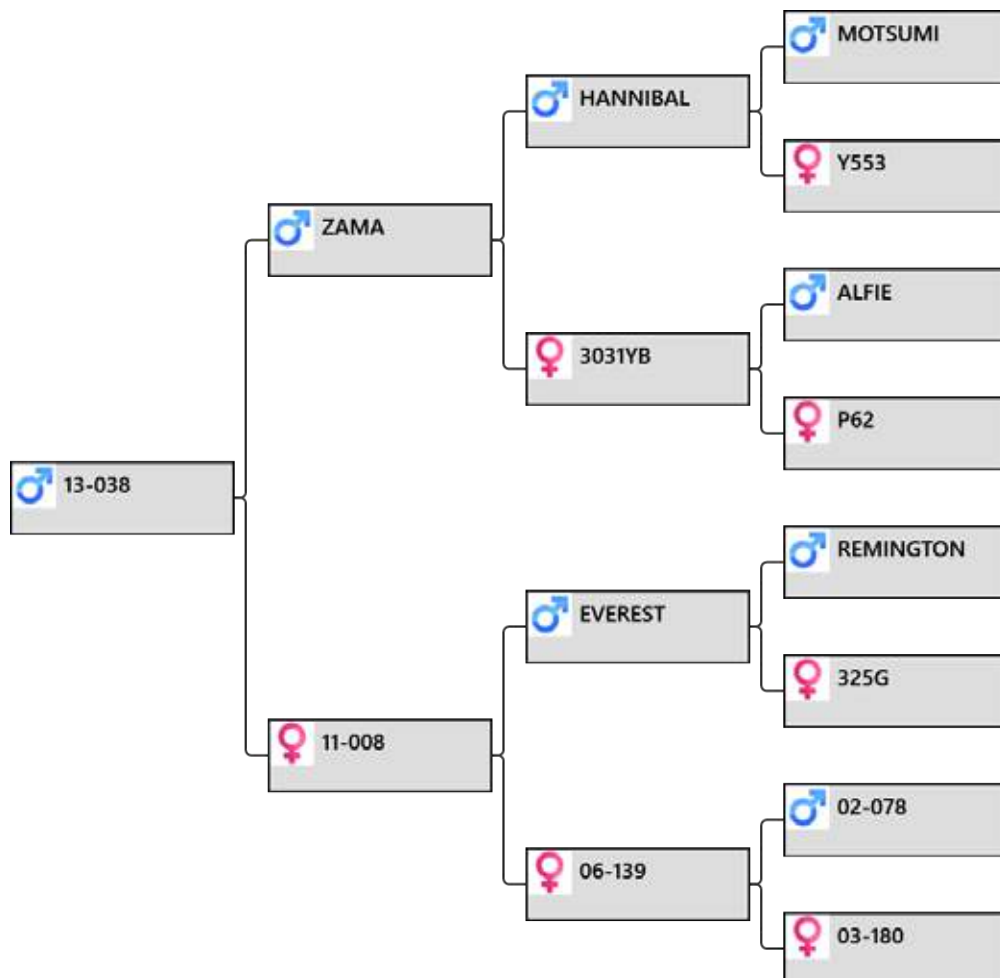

Biography:

38-13 is an ET brother to 89-13 10.6kg @ 3yr that we are retaining and lot 14.

139-06 a son 20-09 sold 2013 for \$5,000

180-03 sons sold 2013 \$3500 and 46-08 2012 for \$4,500

LW 13/12/16 225kg

Sale weight:

Price:

Buyer:



lot # 10 – 3yr sire stag



Animal: **13-045**

Birthdate: 2013

Weigh Date	Weight
30/03/2014	64 kg

Velvet Date	Weight	Grade
1/12/2016	7.40	
1/12/2015	4.50	

3yr Velvet weight: 7.40kg

Pedigree:

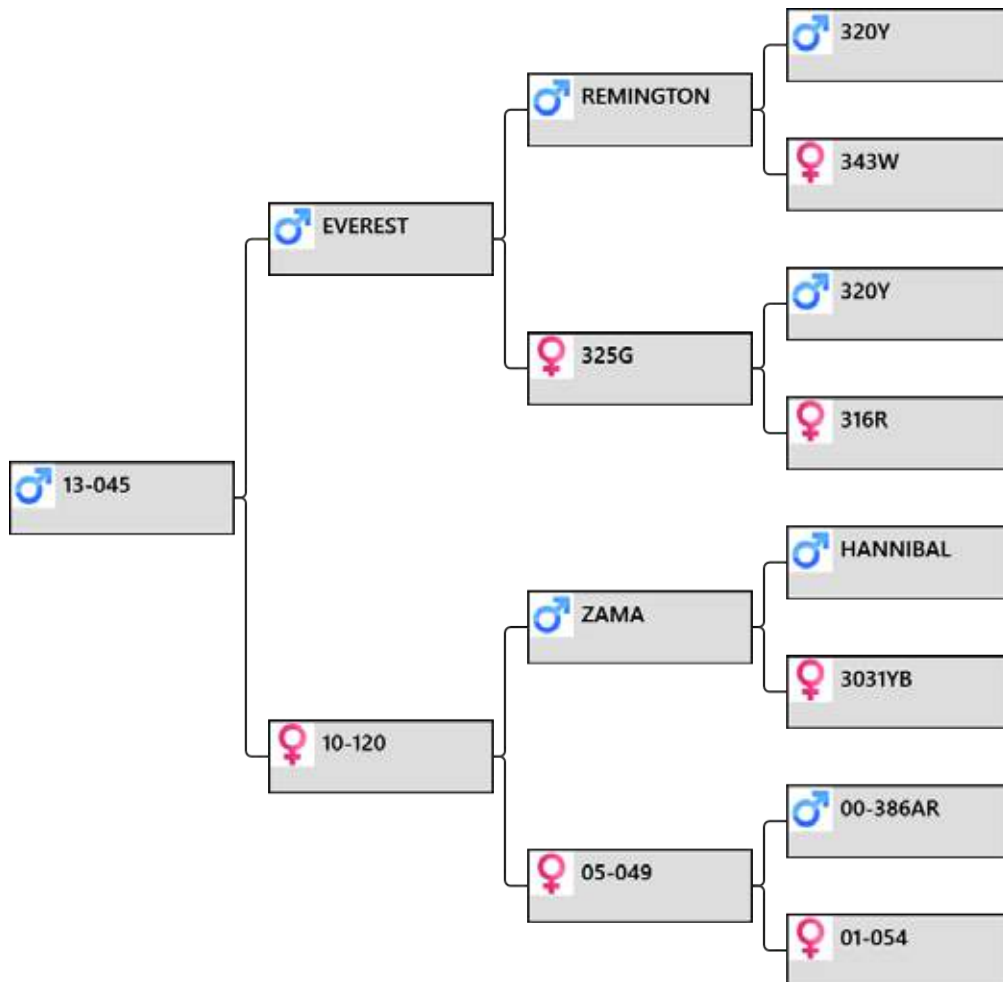

Biography:

Another good Everest son over Supreme Champion Zama down to 54-01 with sons sold for \$4,000, \$4,000 and \$3,000

54-01 is out of that top hind 122-98 who was the grand dam of lot one in both 2015 and 2016 plus G dam of 53-07 (Za Co Zee) sold to Joe Crowley and he is the sire of Joseph 14kg and 2016 open champion. LW 13/12/16 178kg

Sale weight:

Price:

Buyer:

lot # 11 – 3yr sire stag



Animal: **13-285**

Birthdate: 2013

Weigh Date	Weight
30/03/2014	62 kg

Velvet Date	Weight	Grade
1/12/2016	7.10	
1/12/2015	5.30	

3yr Velvet weight: 7.10kg

Pedigree:

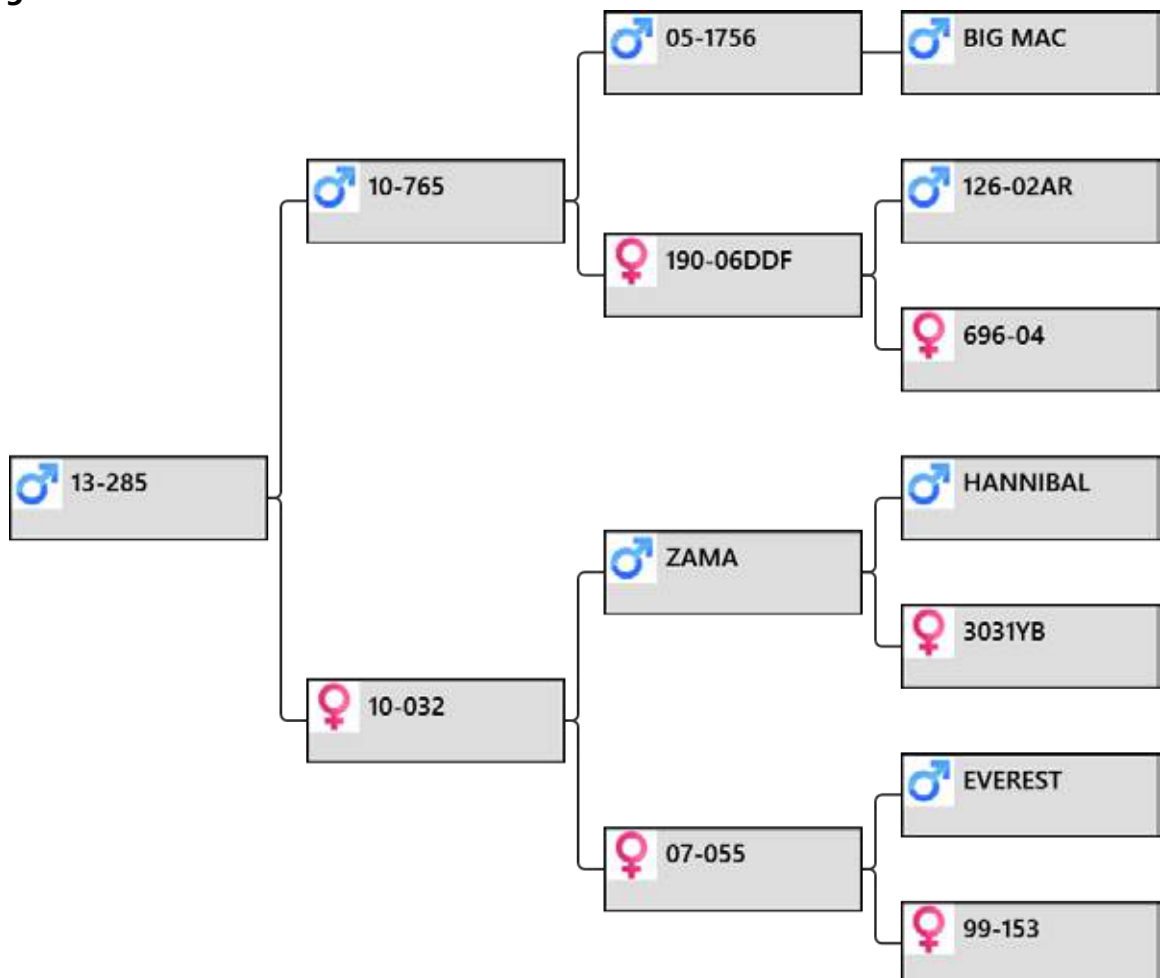

Biography:

Another clean 7kg head with 32-10 being a Zama daughter

Her dam is by Everest the super sire and 55-07 had a daughter sold 2013 for \$2,800

LW 13/12/16 223kg

Sale weight:

Price:

Buyer:



lot # 12 – 3yr sire stag



Animal: **13-240**

Birthdate: 2013

Weigh Date	Weight
30/03/2014	63 kg

Velvet Date	Weight	Grade
1/12/2016	7.05	
1/12/2015	5.80	

3yr Velvet weight: 7.05kg

Pedigree:

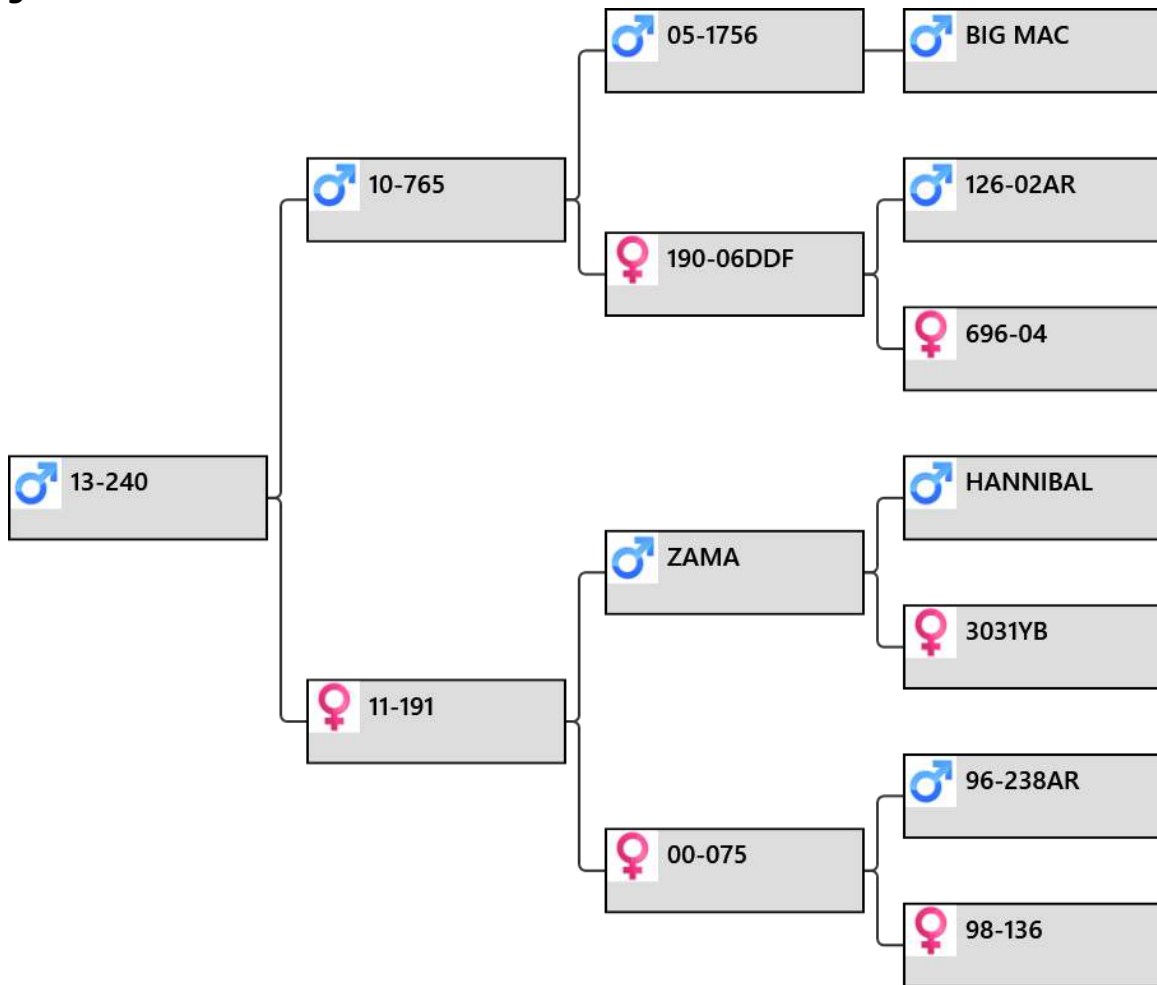

Biography:

240-13 by 765-10 who is leaving very strong heads with strong tynes.

The 765-10 sons in this catalogue are from his first crop.

191-11 by Zama is out of 75-00 who is the dam of 111-09 sold for \$7,000 2013 and a 470 SCI trophy stag.

LW 13/12/16 223kg

Sale weight:

Price:

Buyer:

lot # 13 – 3yr sire stag



Animal: **13-106**

Birthdate: 2013

Weigh Date	Weight
30/03/2014	58 kg

Velvet Date	Weight	Grade
1/12/2016	6.70	
1/12/2015	4.25	

3yr Velvet weight: 6.70kg

Pedigree:

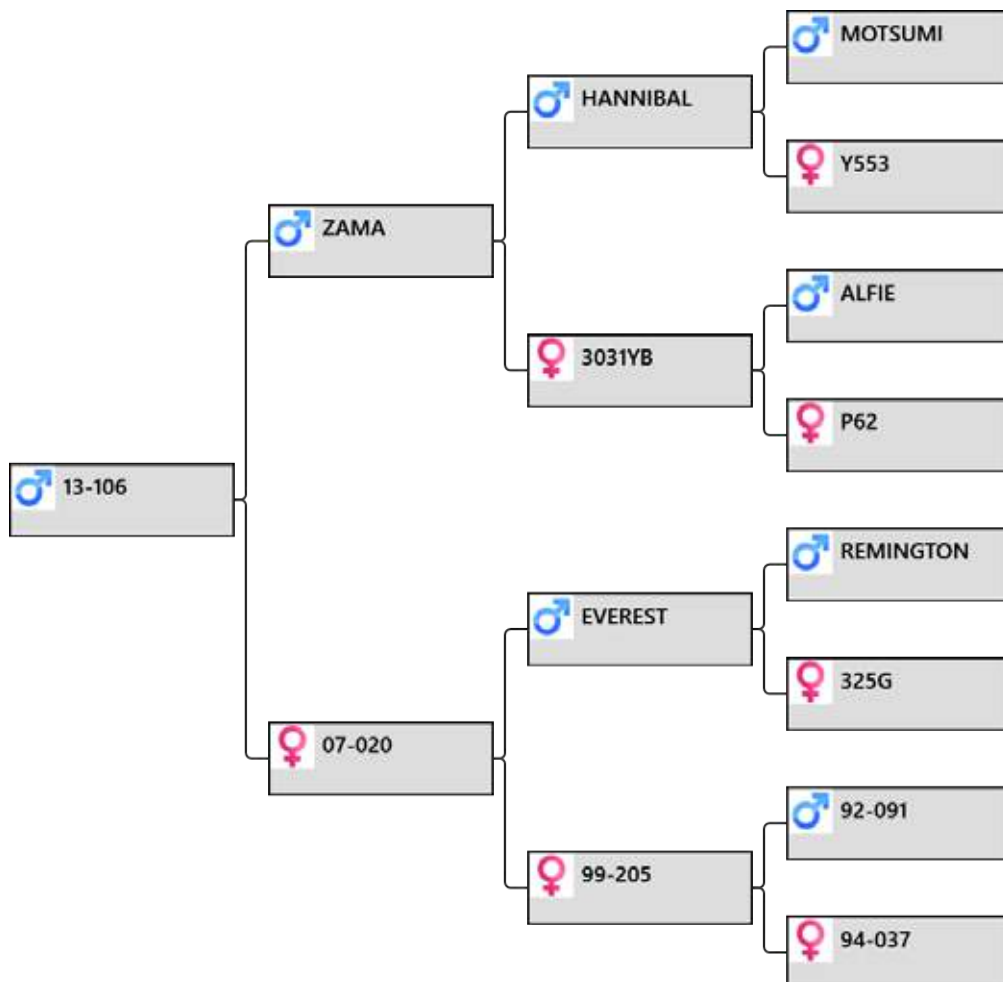

Biography:

106-13 a Zama 12.25kg SA son

20-07 by Everest possibly the top velvet sire in the industry

20-07 dam of lot 3 2016 \$11,000 and she has a daughter with a son sold

lot 8 2016 \$10,000

LW 13/12/16 200kg

Sale weight:

Price:

Buyer:



lot # 14 – 3yr sire stag



Animal: **13-021**

Birthdate: 2013

Weigh Date	Weight
30/03/2014	72 kg

Velvet Date	Weight	Grade
1/12/2016	6.40	
1/12/2015	5.05	

3yr Velvet weight: 6.40kg

Pedigree:

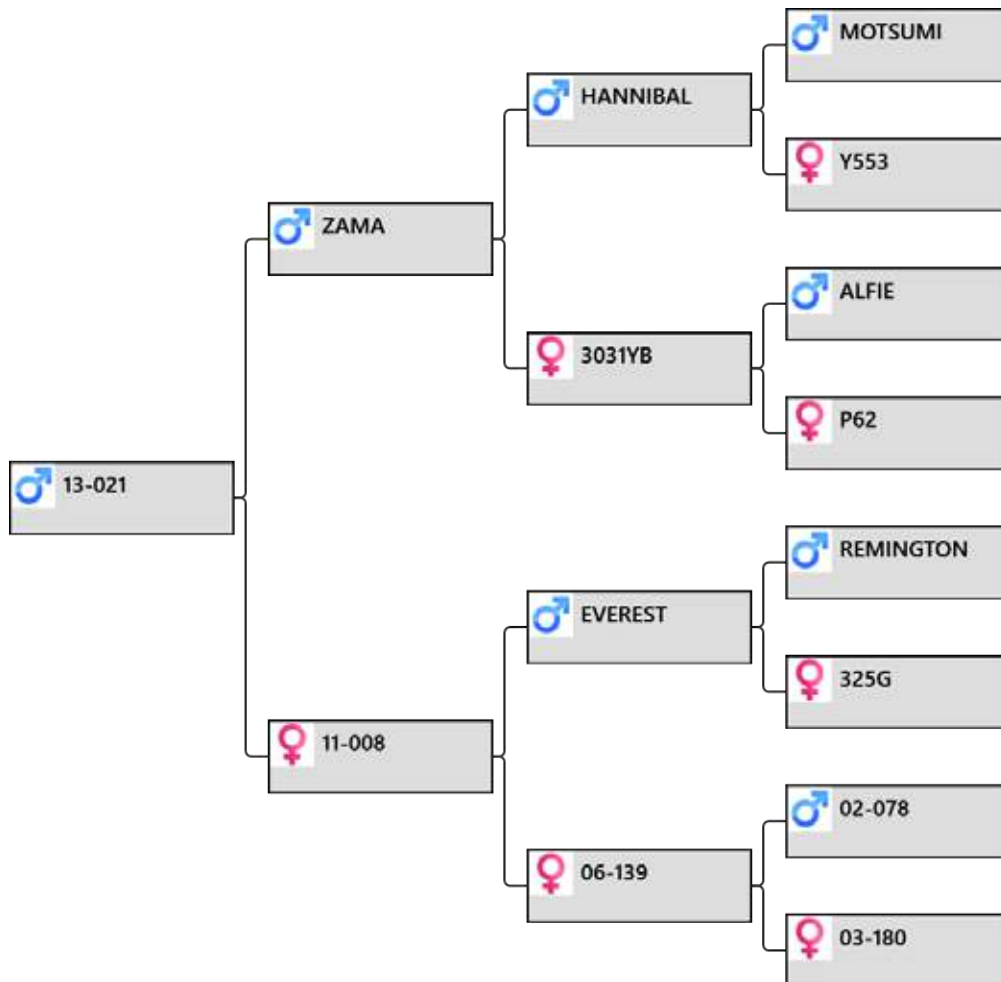

Biography:

21-13 an ET brother to 89-13 10.6kg SA @ 3yr being retained and lot 9 38-13 7.85kg
 139-06 son sold 2013 20-09 \$5,000
 180-03 sons sold 10-09 2013 \$3,500 and 46-08 2012 \$4,500
 Even Grand Dam of 180-03, 16-89 produced a 4kg 2yr old.
 LW 13/12/16 214kg

Sale weight:

Price:

Buyer:

lot # 15 – 3yr sire stag



Animal: **13-018**

Birthdate: 2013

Weigh Date	Weight
30/03/2014	67 kg

Velvet Date	Weight	Grade
1/12/2016	6.25	
1/12/2015	3.80	

3yr Velvet weight: 6.25kg

Pedigree:

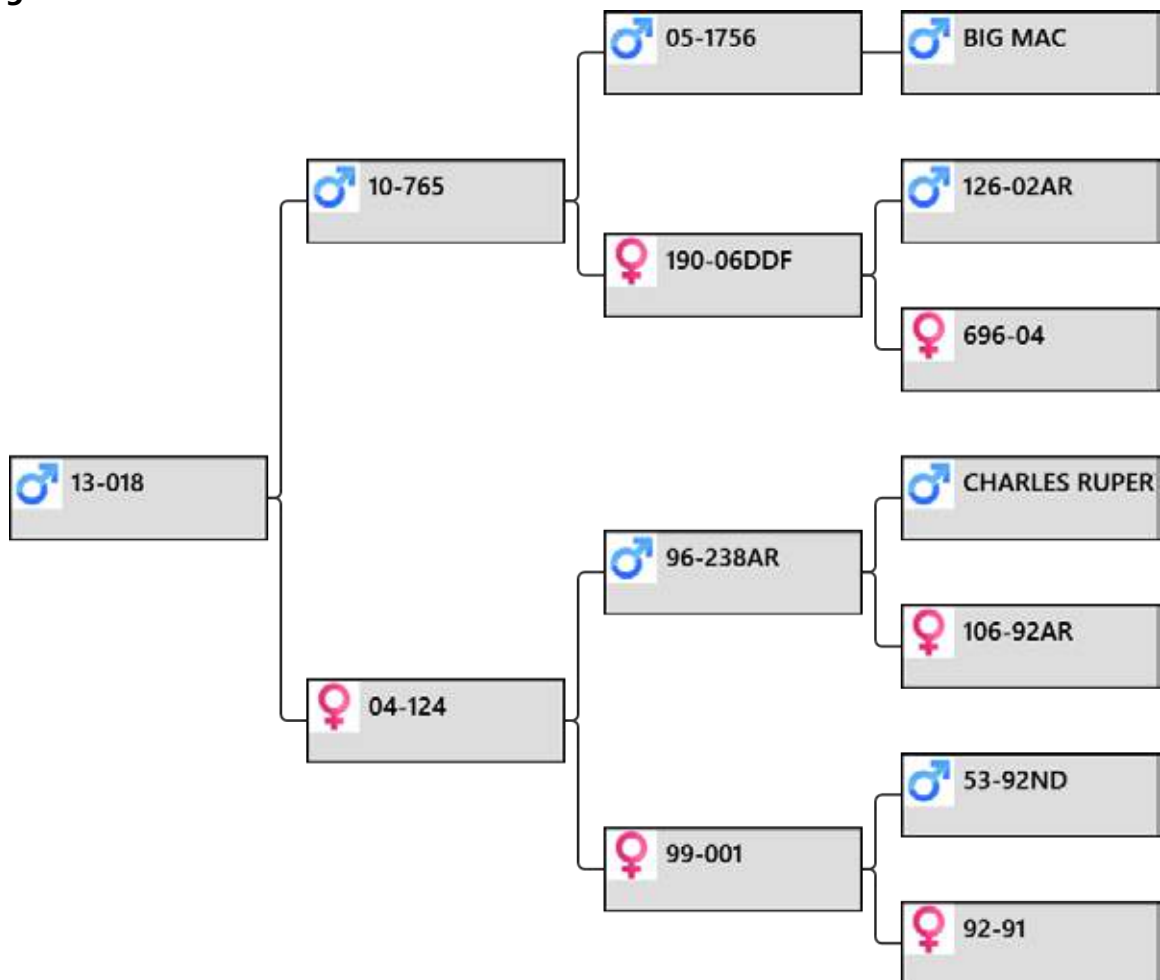

Biography:

18-13 ET brother to lot 8 82-13 7.7kg

124-04 dam of top sire 81-06 18.4kg SS and sire of lots 2, 3 and 5 this year and lot one 2014 \$20,000.

Lw 13/12/16 189.5kg

Sale weight:

Price:

Buyer:



lot # 16 – 3yr sire stag



Animal: **13-012**

Birthdate: 2013

Weigh Date	Weight
30/03/2014	69 kg

Velvet Date	Weight	Grade
1/12/2016	6.20	
1/12/2015	3.80	

3yr Velvet weight: 6.20kg

Pedigree:

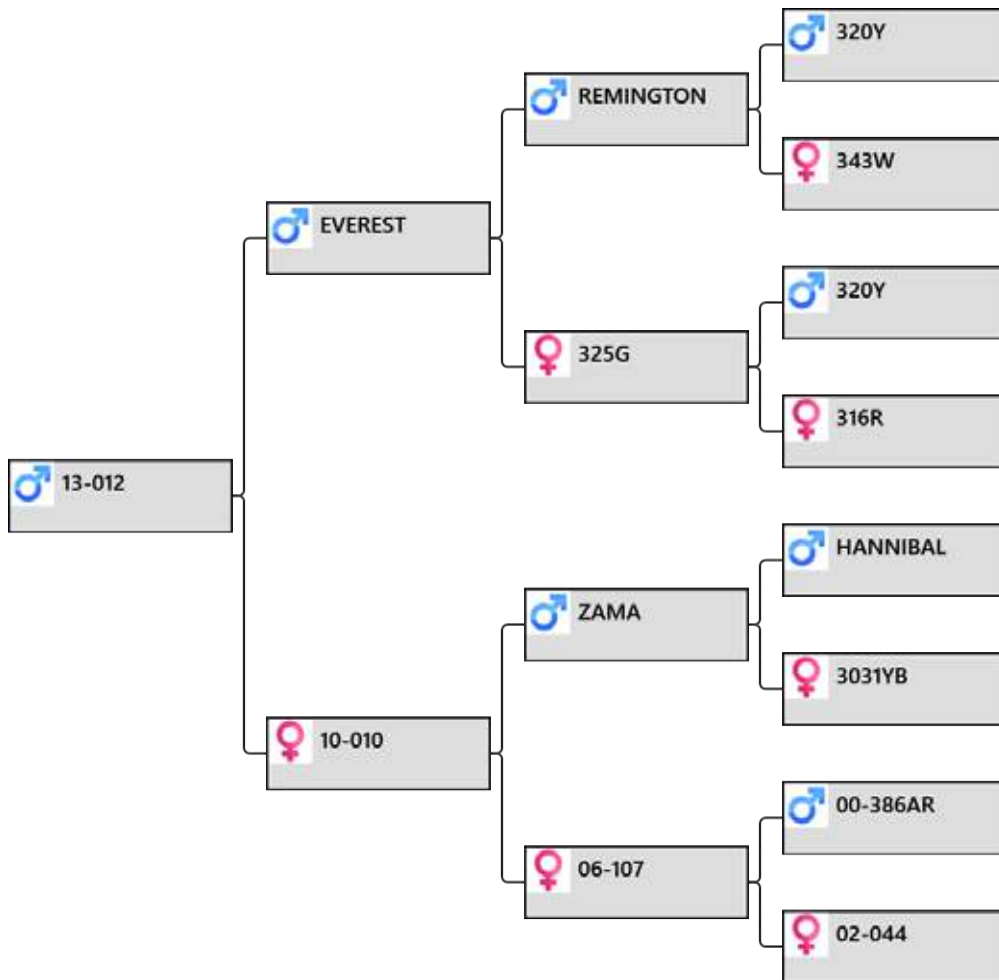

Biography:

Nice tidy velvet from this stag by super sire Everest

His dam Zama daughter 10-10 had a daughter sold 2016 for \$3,300

LW 13/12/16 214kg

Sale weight:

Price:

Buyer:

lot # 17 – 3yr sire stag



Animal: **13-199**

Birthdate: 2013

Weigh Date	Weight
30/03/2014	65 kg

Velvet Date	Weight	Grade
1/12/2016	6.20	
1/12/2015	4.25	

3yr Velvet weight: 6.20kg

Pedigree:

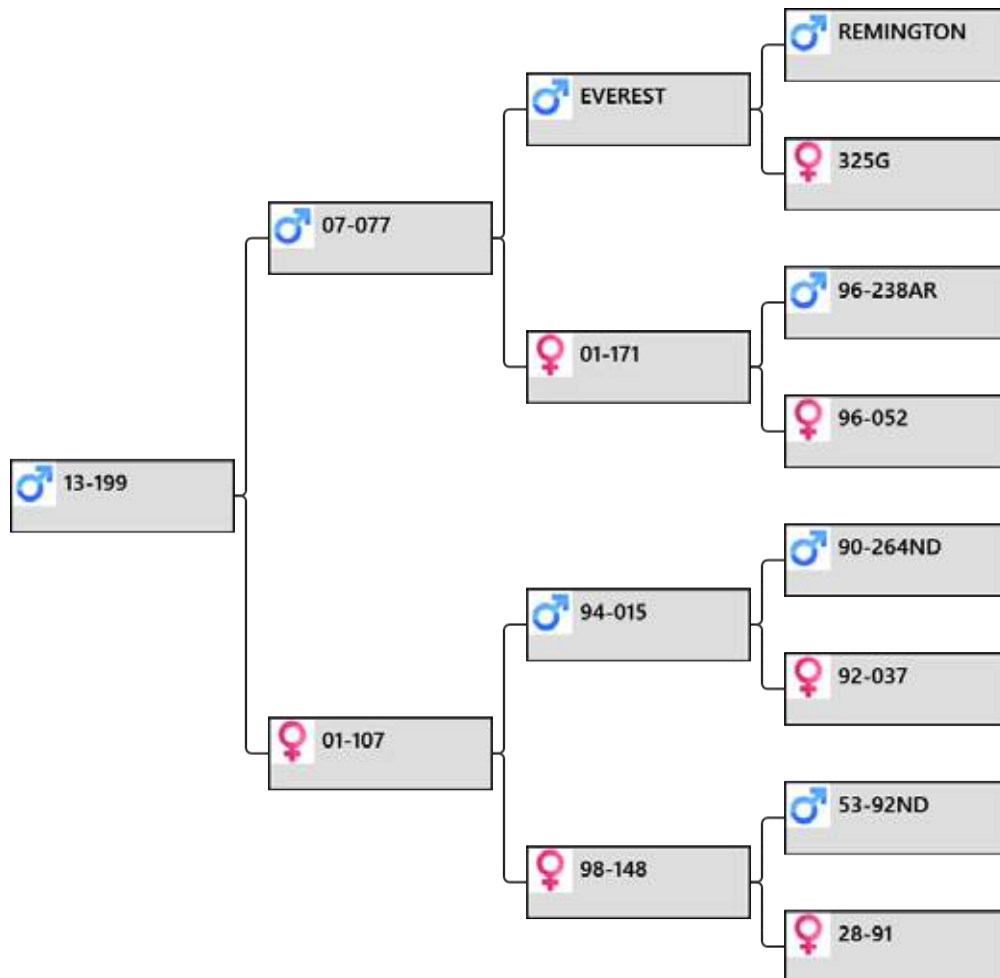

Biography:

199-13 by 77-07 10kg @ 6yr then sold to Regan Blair.

107-01 dam of trophy 440 SCI

28-91 dam of sire 12-95 used in stud

LW 13/12/16 210kg

Sale weight:

Price:

Buyer:



lot # 18 – 3yr sire stag



Animal: **13-117**

Birthdate: 2013

Weigh Date	Weight
30/03/2014	65 kg

Velvet Date	Weight	Grade
1/12/2016	6.30	
1/12/2015	3.90	

3yr Velvet weight: 6.30kg

Pedigree:

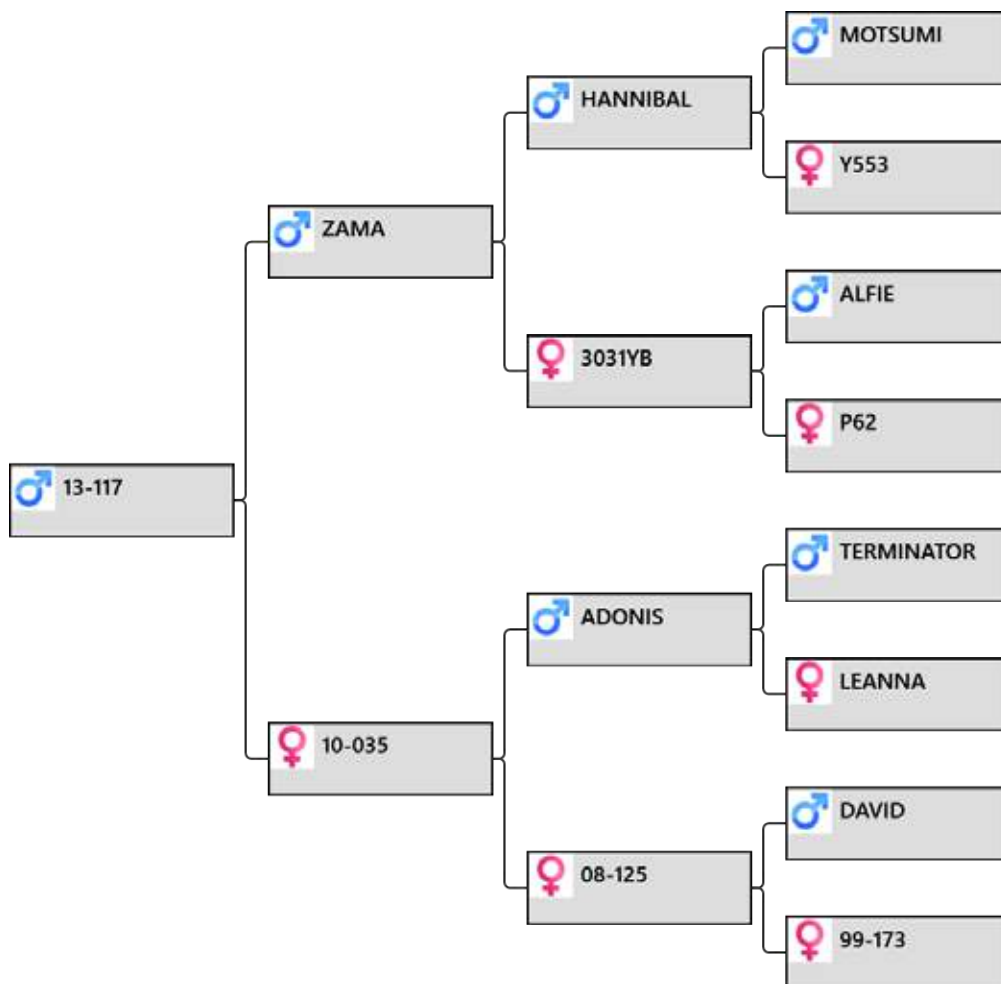

Biography:

A very clean head of velvet from 117-13 by Zama 12.25kg SA
 35-10 by Adonis with a son 214-12 cutting 6kg @ 3yr
 125-08 a full sister to 123-04 502 IOA @ 4yr
 Good velvet and trophy genetics.
 LW 13/12/16 207kg

Sale weight:

Price:

Buyer:

lot # 19 – 3yr sire stag



Animal: **13-194**

Birthdate: 2013

Weigh Date	Weight
30/03/2014	58 kg

Velvet Date	Weight	Grade
1/12/2016	6.05	
1/12/2015	5.00	

3yr Velvet weight: 6.05kg

Pedigree:

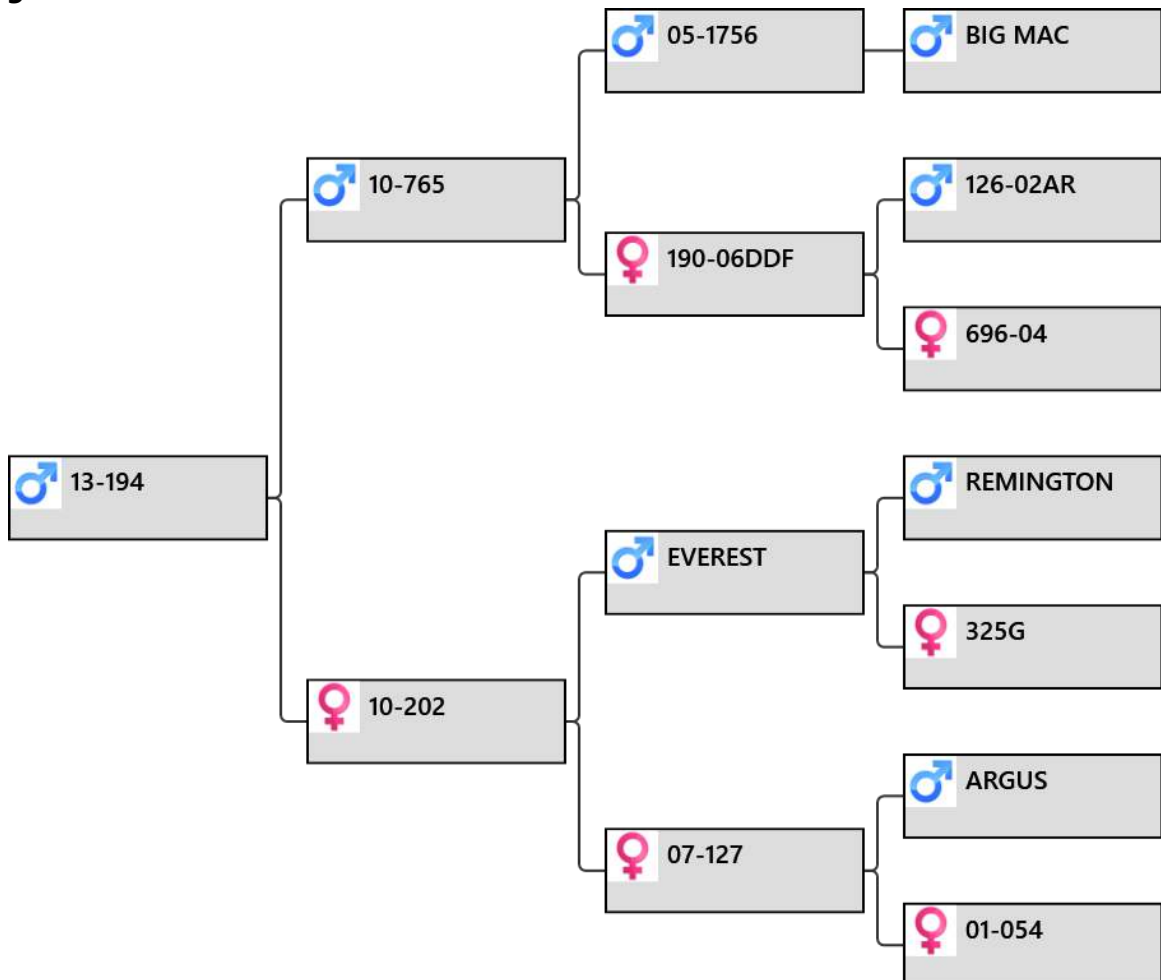

Biography:

194-13 is a twin out of an Everest daughter

127-07 dam of lot three 2015 \$9,500

54-01 dam of twins sold 2012 85-08 and 71-08 both for \$4,000 each. 2013 134-09 \$3,000

54-01 dam is 122-98 that top hind grand dam of lot one 2015 & 2016 plus Za Co Zee

LW 13/12/16 184kg

Sale weight:

Price:

Buyer:



lot # 20 – 3yr sire stag



Animal: **13-124**

Birthdate: 2013

Weigh Date	Weight
30/03/2014	65 kg

Velvet Date	Weight	Grade
1/12/2016	6.05	
1/12/2015	5.10	

3yr Velvet weight: 6.05kg

Pedigree:

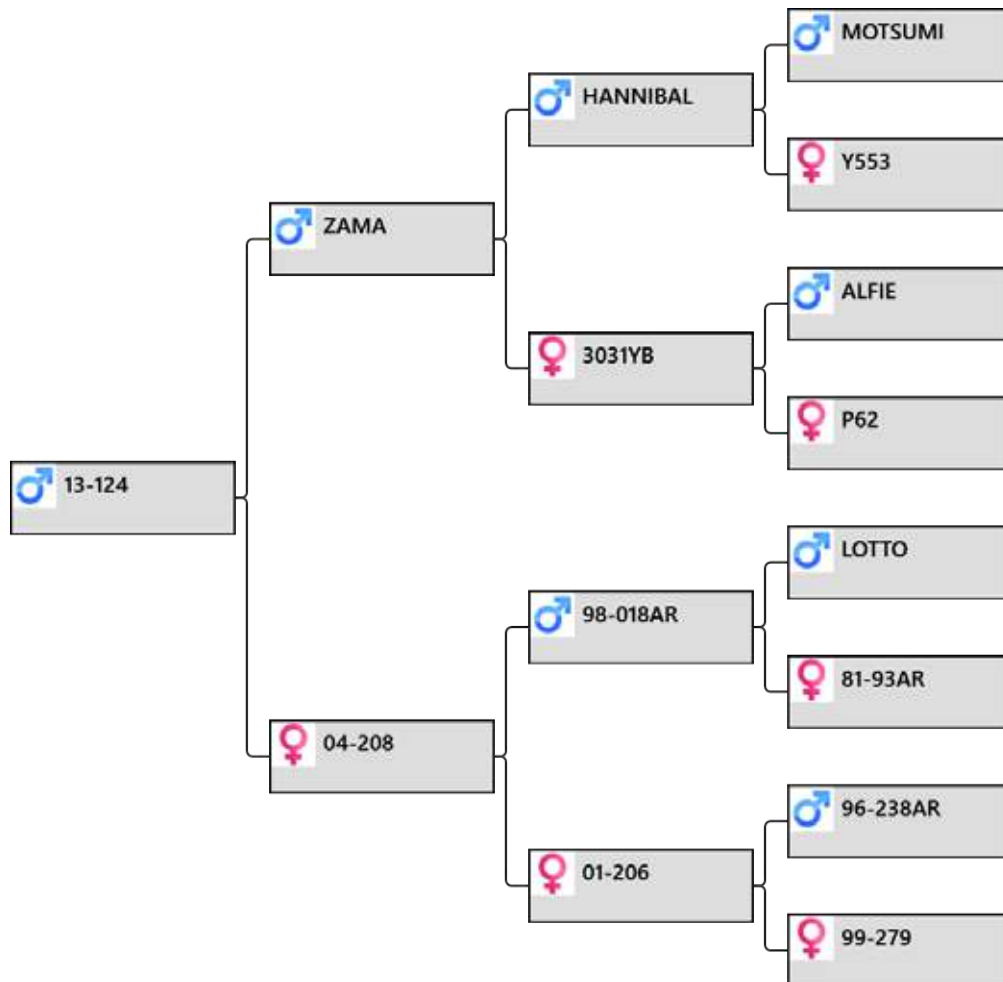

Biography:

124-13 clean tidy velvet by Zama out of 208-04 a super top hind. Dam of lot 4 2016 \$27,000, lot 11 \$7,000, lot 21 \$4,000 Lot 23 \$5,000 plus sons sold for \$10,500, \$5,000 and \$2,500. 279-99 out of 67-92 a son used in stud and her dam 9-90 two sons used in stud.
LW 13/12/16 223kg

Sale weight:

Price:

Buyer:

lot # 21 – 3yr sire stag



Animal: **13-084**

Birthdate: 2013

Weigh Date	Weight
30/03/2014	70 kg

Velvet Date	Weight	Grade
1/12/2016	6.05	
1/12/2015	6.15	

3yr Velvet weight: 6.05kg

Pedigree:

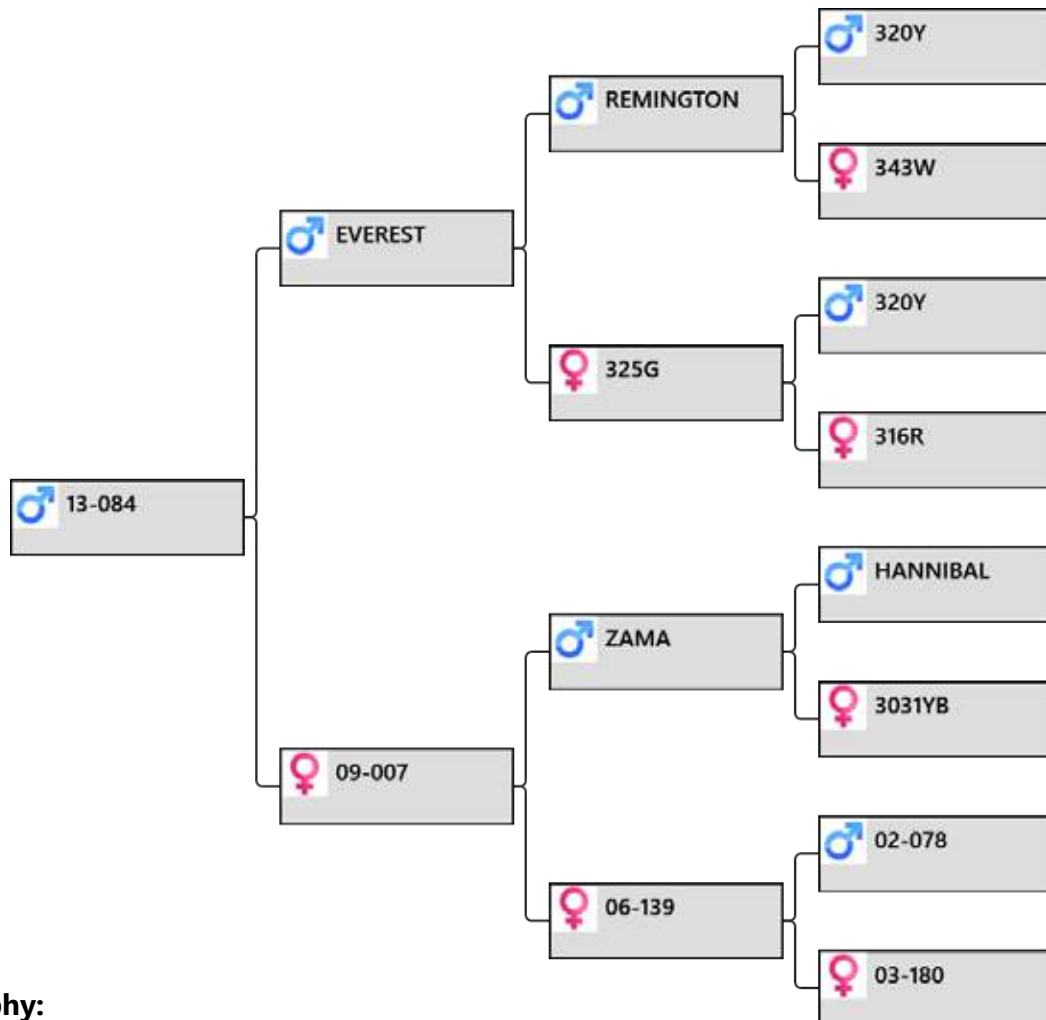

Biography:

84-13 ET brother to lot 7 91-13 by Everest 12.25kg
 7-09 by Zama 12.25kg
 139-06 a son 20-09 sold 2013 \$5,000.
 180-03 sons sold 2012 \$4,500 and 2013 \$3,500
 LW 13/12/16 203kg

Sale weight:

Price:

Buyer:



lot # 22 – 3yr sire stag



Animal: **13-047**

Birthdate: 2013

Weigh Date	Weight
30/03/2014	64 kg

Velvet Date	Weight	Grade
1/12/2016	6.05	
1/12/2015	4.70	

3yr Velvet weight: 6.05kg

Pedigree:

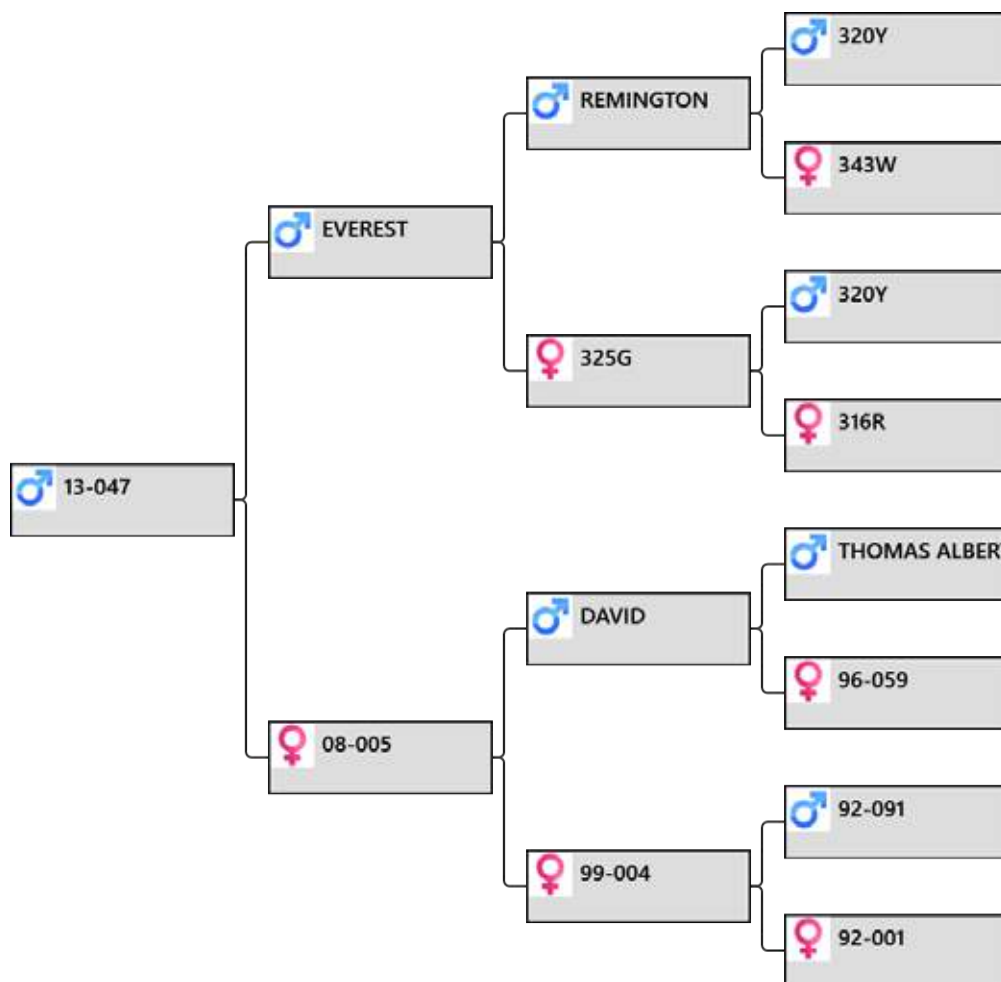

Biography:

Very clean head on this Everest son
 5-08 by David 11kg SA
 4-99 and 1-92 have both had sons sold as trophy stags.
 LW 13/12/16 211kg.

Sale weight:

Price:

Buyer:

lot # 23 – 3yr sire stag



Animal: **13-195**

Birthdate: 2013

Weigh Date	Weight
30/03/2014	69 kg

Velvet Date	Weight	Grade
1/12/2016	6.05	
1/12/2015	4.25	

3yr Velvet weight: 6.05kg

Pedigree:

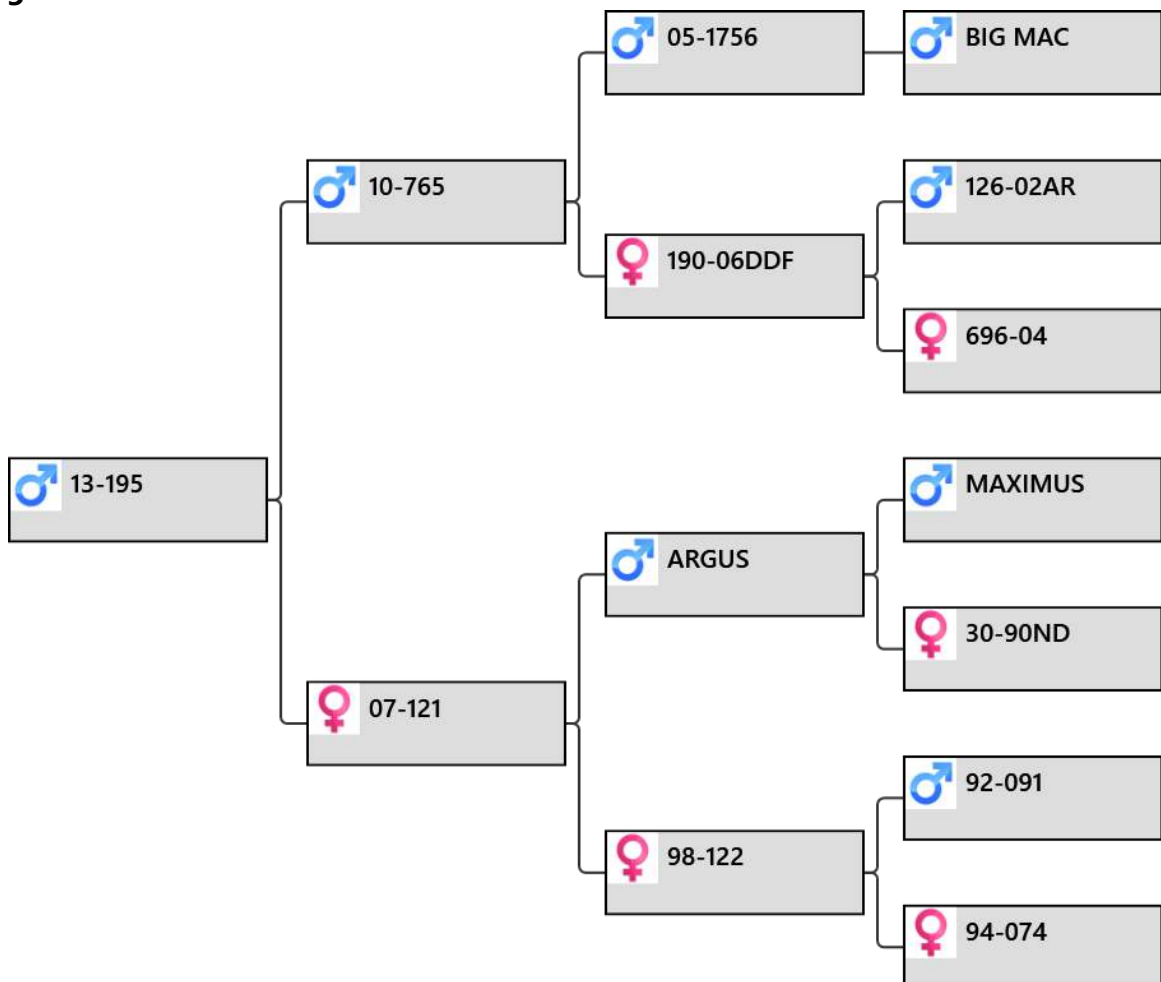

Biography:

This stag is out of 121-07 dam of lot 1 last year \$67,000.

Last year her son was by Everest but this head is very clean and correct too.

122-98 the grand dam of another good stag to go with being G dam of lot one 2015 & 2016 plus Grand dam of Za Co Zee sold to Tower Farms and appears a lot in their latest catalogue. LW 13/12/16 213kg

Sale weight:

Price:

Buyer:



lot # 24 – 3yr sire stag



Animal: **13-172**

Birthdate: 2013

Weigh Date	Weight
30/03/2014	78 kg

Velvet Date	Weight	Grade
1/12/2016	7.00	
1/12/2015	4.55	

3yr Velvet weight: 7.00kg

Pedigree:

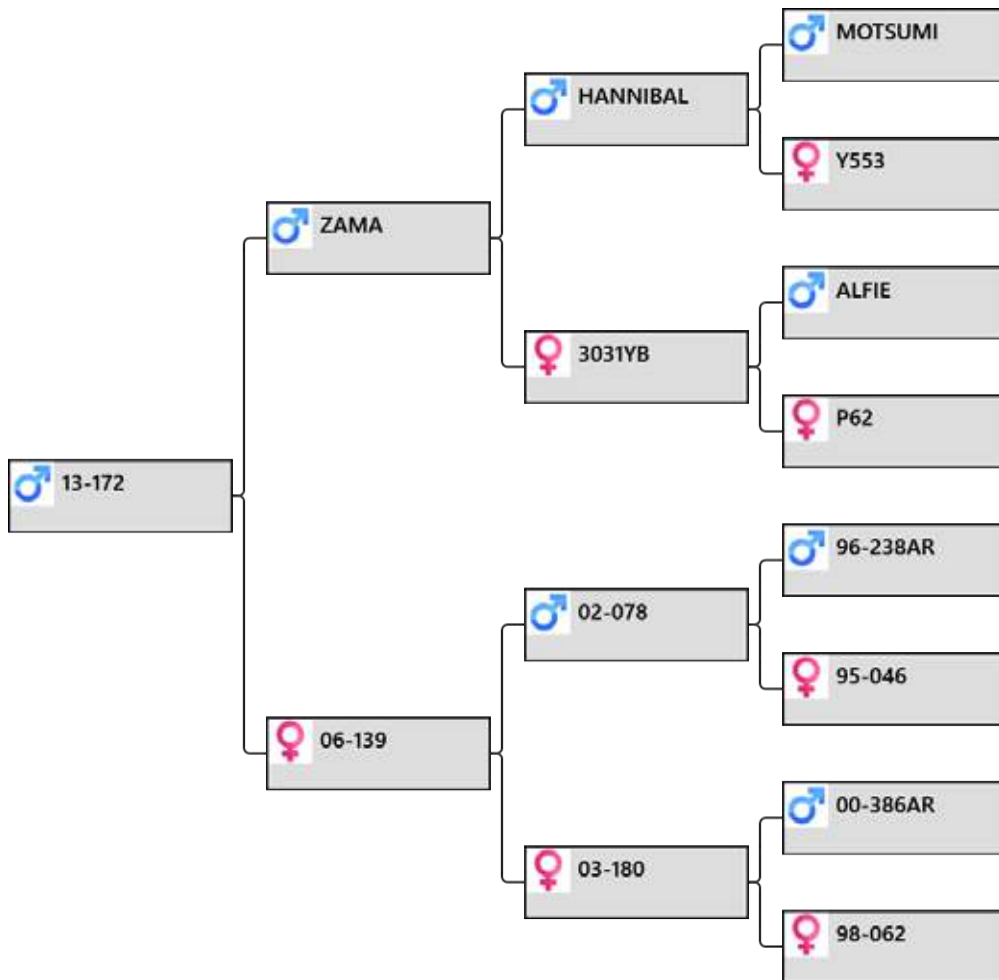

Biography:

Zama son out of 139-06 who is the grand dam of lots 7 & 21.

139-06 a son 20-09 sold 2013 \$5,000

180-03 sons sold 2012 \$4,500 and 2013 \$3,500

LW 13/12/16 222kg

Sale weight:

Price:

Buyer:

lot # 25 – 3yr sire stag



Animal: **13-180**

Birthdate: 2013

Weigh Date	Weight
30/03/2014	81 kg

Velvet Date	Weight	Grade
1/12/2016	6.00	
1/12/2015	4.75	

3yr Velvet weight: 6.00kg

Pedigree:

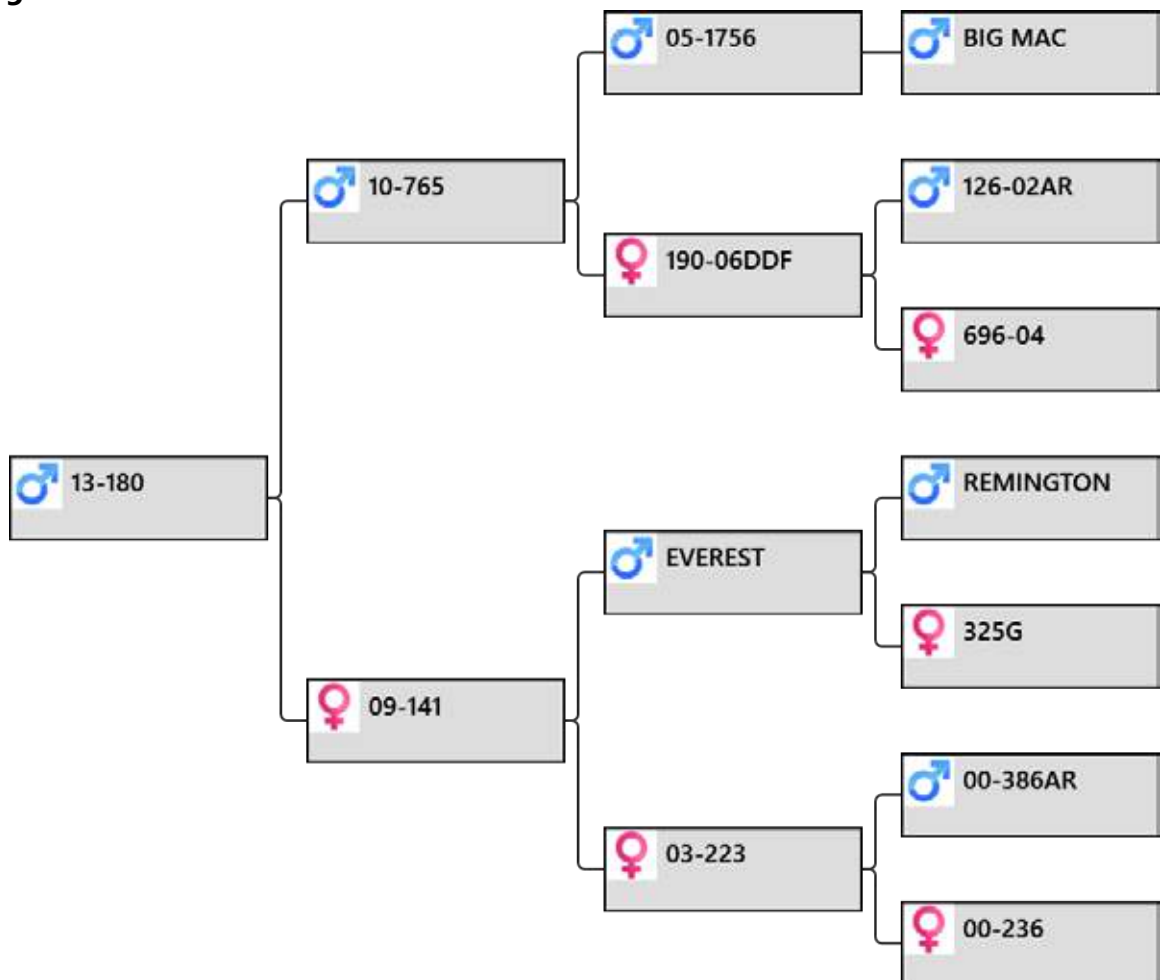

Biography:

Another very clean and correct head of velvet.
 once again out of an Everest daughter.
 LW 13/12/16 216kg

Sale weight:

Price:

Buyer:



lot # 26 – 3yr sire stag



Animal: **13-125**

Birthdate: 2013

Weigh Date	Weight
30/03/2014	64 kg

Velvet Date	Weight	Grade
1/12/2016	6.00	
1/12/2015	4.30	

3yr Velvet weight: 6.00kg

Pedigree:

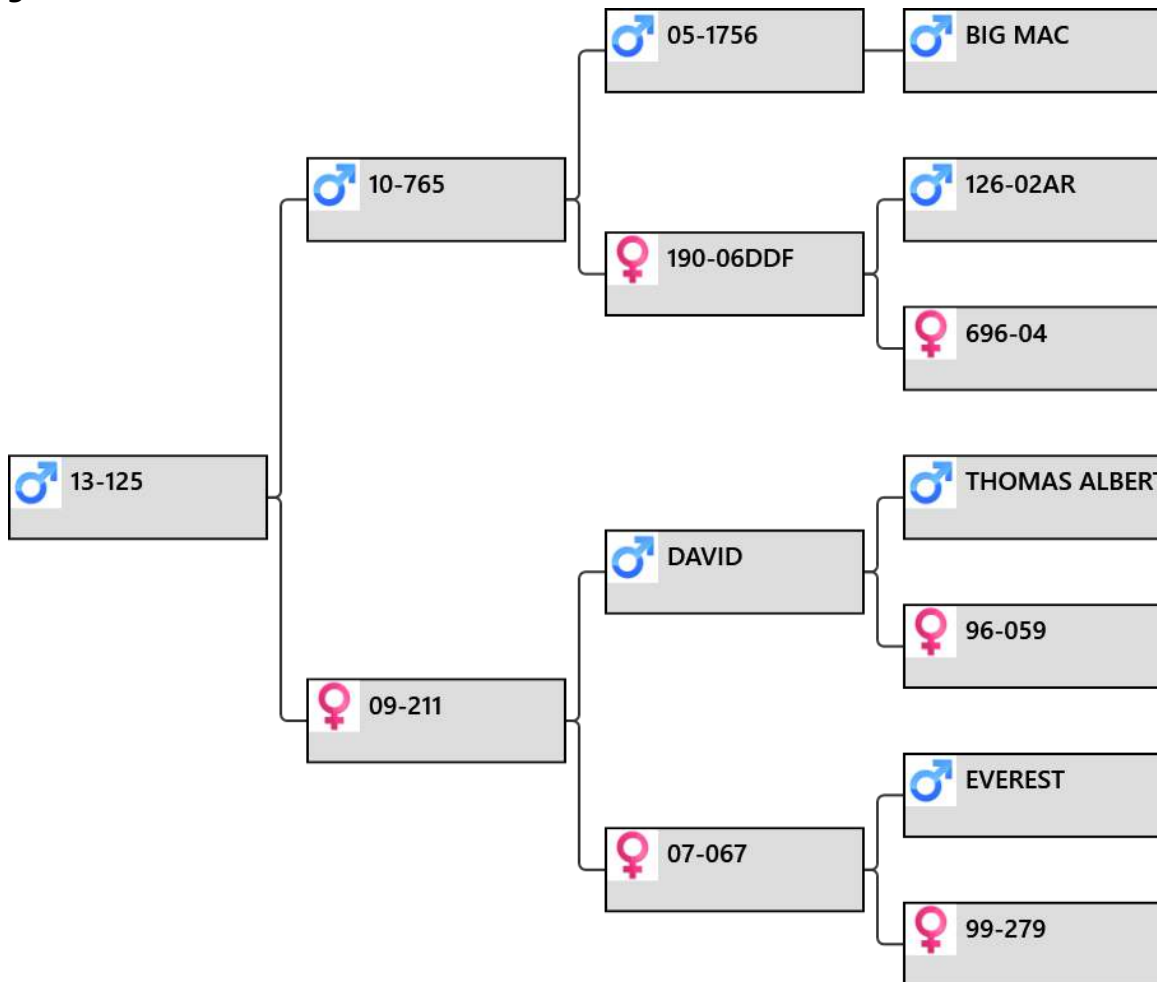

Biography:

125-13 has snags but correct head by 765-10 8.1kg SA 3yr

211-09 by David 11kg SA

67-07 another Everest Daughter.

The dam and Grand dam of 279-99 had sons used in stud.

LW 13/12/16 193kg.

Sale weight:

Price:

Buyer:

lot # 27 – 4yr sire stag



Animal: **12-020PF**

Birthdate: 2012

Weigh Date	Weight
6/12/2015	7 kg

Velvet Date	Weight	Grade
1/12/2016	8.00	
1/12/2015	6.60	

4yr Velvet weight: 8.00kg

4yr sire

Pedigree:

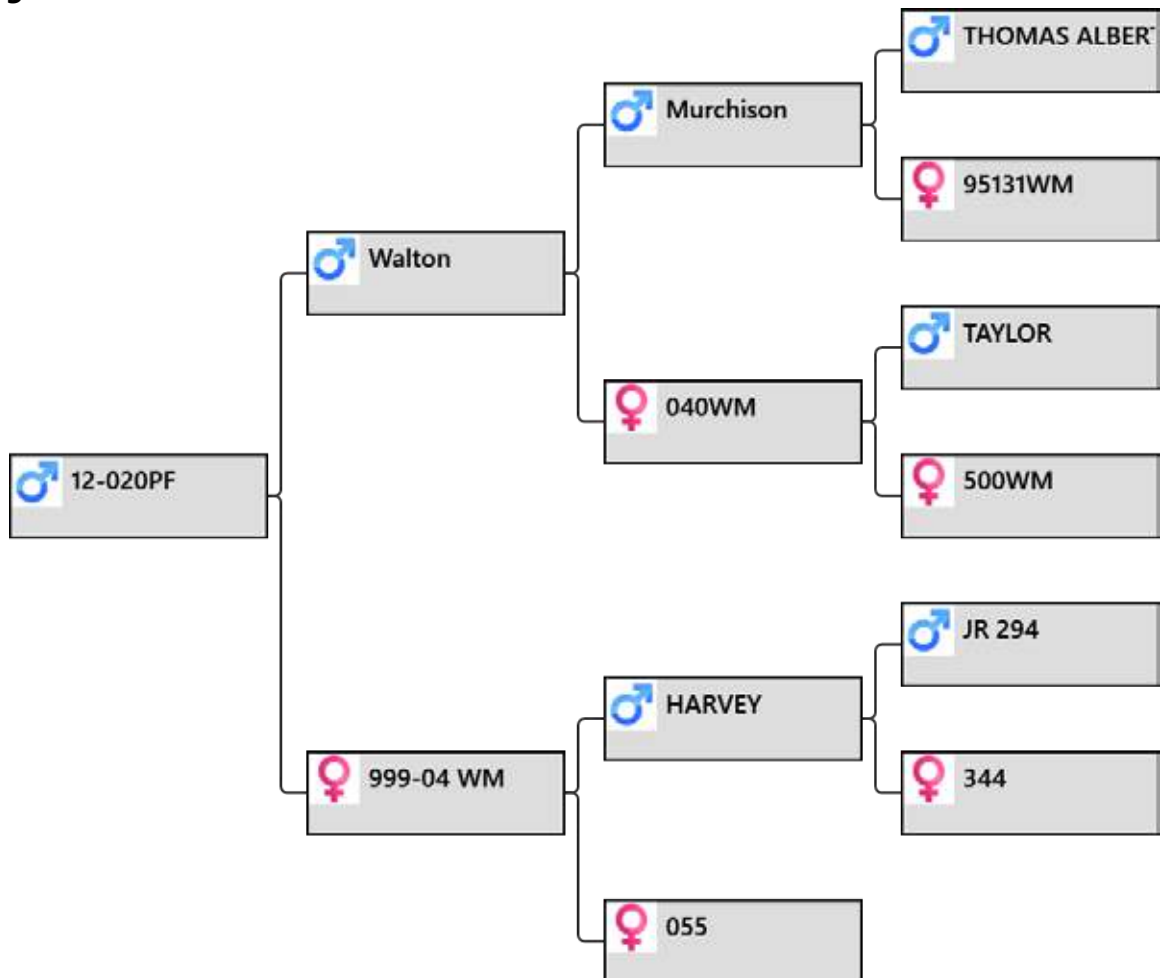

Biography:

We bought this stag as a 2yr old from Peel Forest for \$14,000

We have used him but now he is surplus and we have decided to sell him.

He has produced a nice tidy head as a three yr old and as you can see as a 4yr old

Sale weight:

Price:

Buyer:



lot # 28 – 4yr sire stag



Animal: **12-247**

Birthdate: 2012

Weigh Date	Weight
26/03/2013	61 kg

Velvet Date	Weight	Grade
1/12/2016	8.20	
1/12/2015	6.55	
1/11/2014	4.15	

4 yr Velvet weight: 8.20kg

4yr sire

Pedigree:

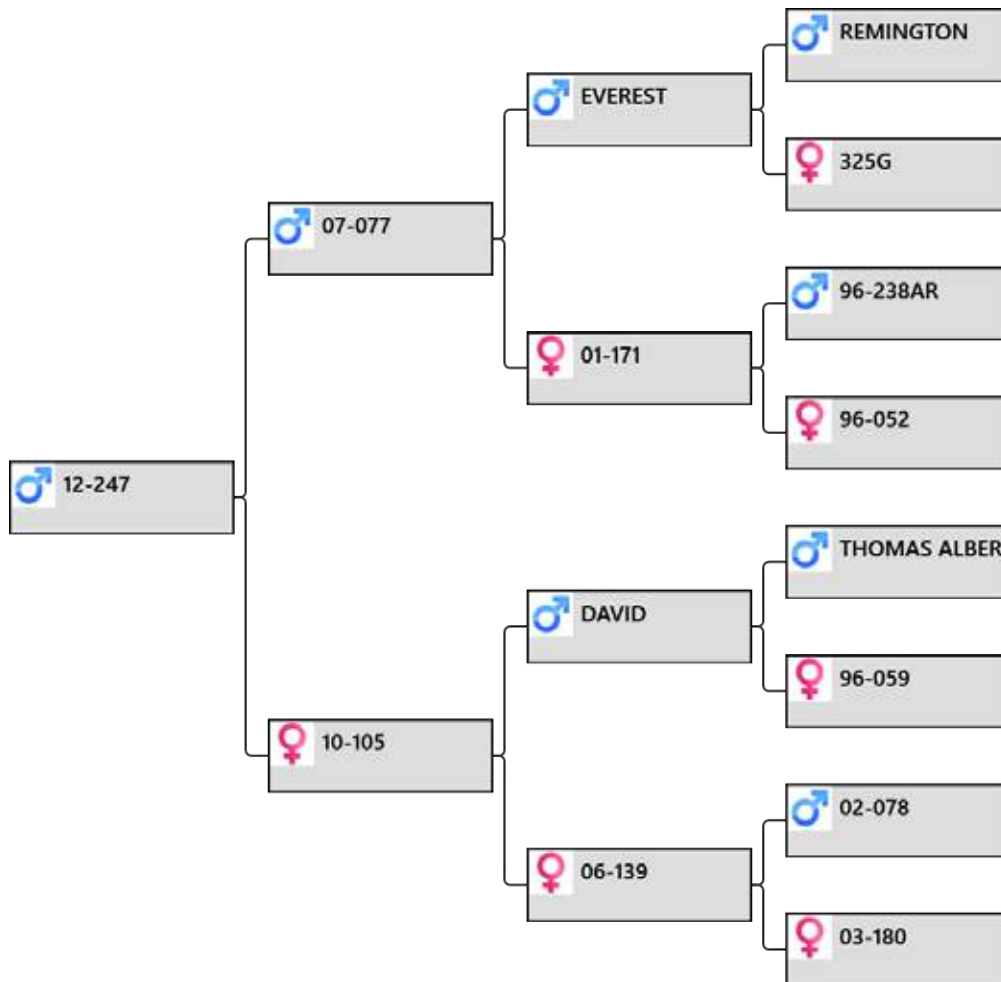

Biography:

This stag was one of the 2 that did not make the sale last year because we limited it to 25 3yr olds. He has a very good head this year at 4 yr old.

77-07 10kg @ 6yr. 139-06 a top hind that appears in this catalogue a lot with a son sold 2013 for \$5,000

180-03 sons sold 2012 \$4,500 and 2013 \$3,500

Sale weight:

Price:

Buyer:

velveting stags

Approximately 60 two year old velveting stags for sale – look out for the catalogue on our website sometime between Christmas and New Year 2017.

yearling hinds

Some very good yearling hinds on offer with some being catalogued just because their dam has only produced females to date or male progeny has not reached 2yrs of age yet (so no sons to rank their velvet potential on).

**Please note: these hinds
are catalogued in
tag order (ie not ranked)**



lot # 40 – Yearling hind

 <p>performance recorded since 1985</p> <p>Yearling Hind sale 2017</p>	<p>Animal: 15-004</p> <hr/> <p>Birthdate: 2015</p> <table border="1"> <thead> <tr> <th>Weigh Date</th> <th>Weight</th> </tr> </thead> <tbody> <tr> <td>5/04/2016</td> <td>58 kg</td> </tr> <tr> <td>28/11/2016</td> <td>84 kg</td> </tr> </tbody> </table>	Weigh Date	Weight	5/04/2016	58 kg	28/11/2016	84 kg
	Weigh Date	Weight					
5/04/2016	58 kg						
28/11/2016	84 kg						

Pedigree:

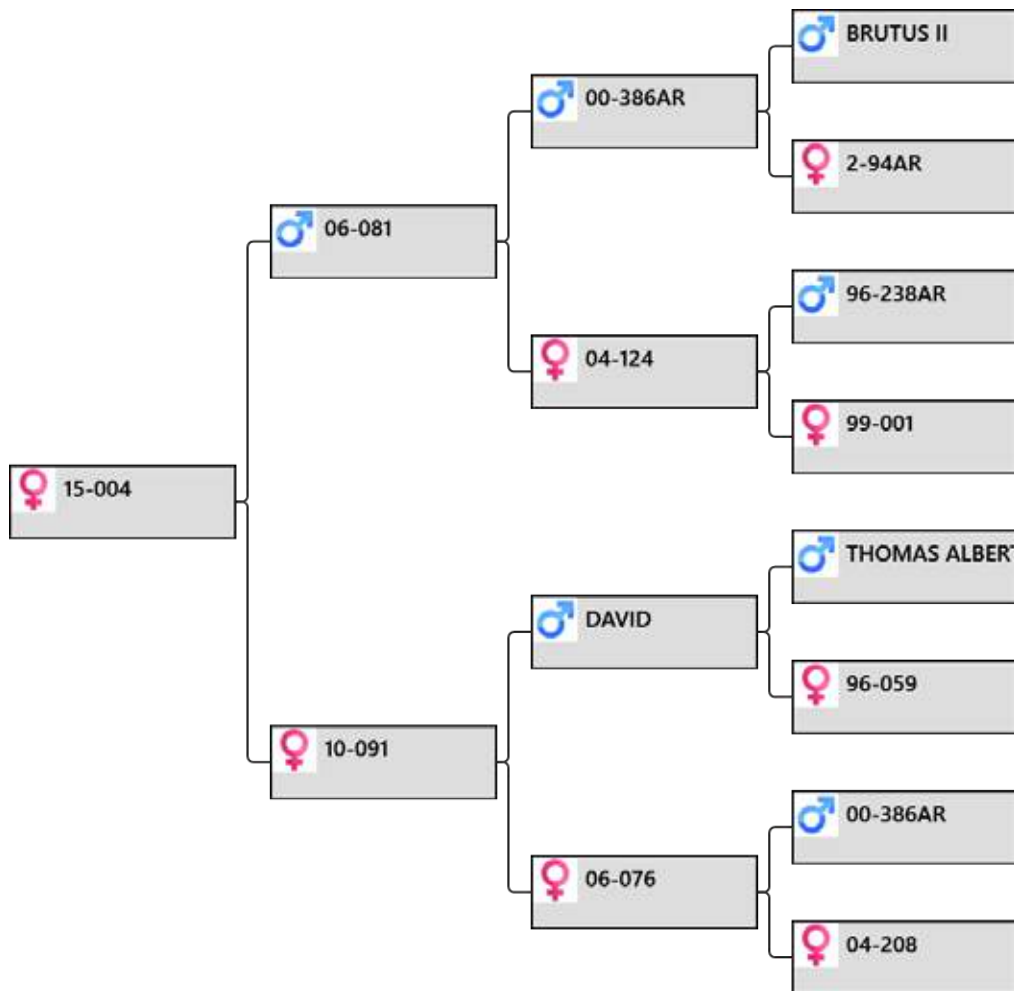

Biography:

4-15 by 81-06 4yr champion, this yr huge 18.4kg SS.
 91-10 son cutting 3.75 @ 2yr.
 76-06 son sold 2016. Sons cutting 4.65, 4kg & 3.85kg @ 2yr
 208-04 top hind with 4 ET sons sold 2016 with best one \$27,000

Sale weight:

Price:

Buyer:

lot # 41 – Yearling hind



**Altrive
Red Deer**
performance recorded since 1985
Yearling Hind sale 2017

Animal: **15-006**

Birthdate: 2015

Weigh Date	Weight
5/04/2016	61 kg
28/11/2016	81 kg

Pedigree:

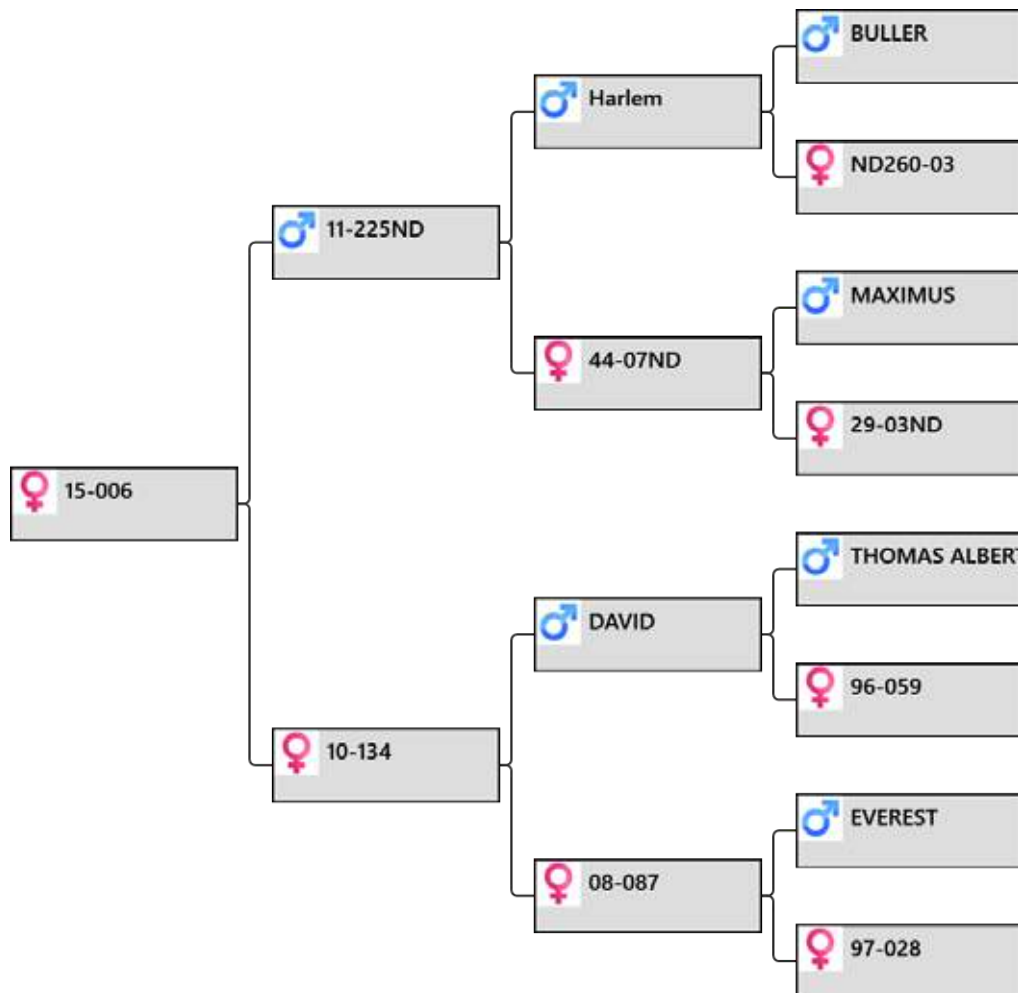

Biography:

6-15 sired by ND225-11 12kg 5yr out of 134-10 by David 11kg
 134-10 daughters sold 2014 \$2100, 2016 \$1800
 87-08 son sold 2015 \$4500 & 4 daughters
 28-97 son sold as sire & 2 sons cut 4kg & 4.4kg @ 2yr

Sale weight:

Price:

Buyer:



lot # 42 – Yearling hind

 <p>performance recorded since 1985 Yearling Hind sale 2017</p>	<p>Animal: 15-012</p> <hr/> <p>Birthdate: 2015</p> <table border="1"> <thead> <tr> <th>Weigh Date</th> <th>Weight</th> </tr> </thead> <tbody> <tr> <td>5/04/2016</td> <td>59 kg</td> </tr> <tr> <td>28/11/2016</td> <td>84 kg</td> </tr> </tbody> </table>	Weigh Date	Weight	5/04/2016	59 kg	28/11/2016	84 kg
	Weigh Date	Weight					
5/04/2016	59 kg						
28/11/2016	84 kg						

Pedigree:

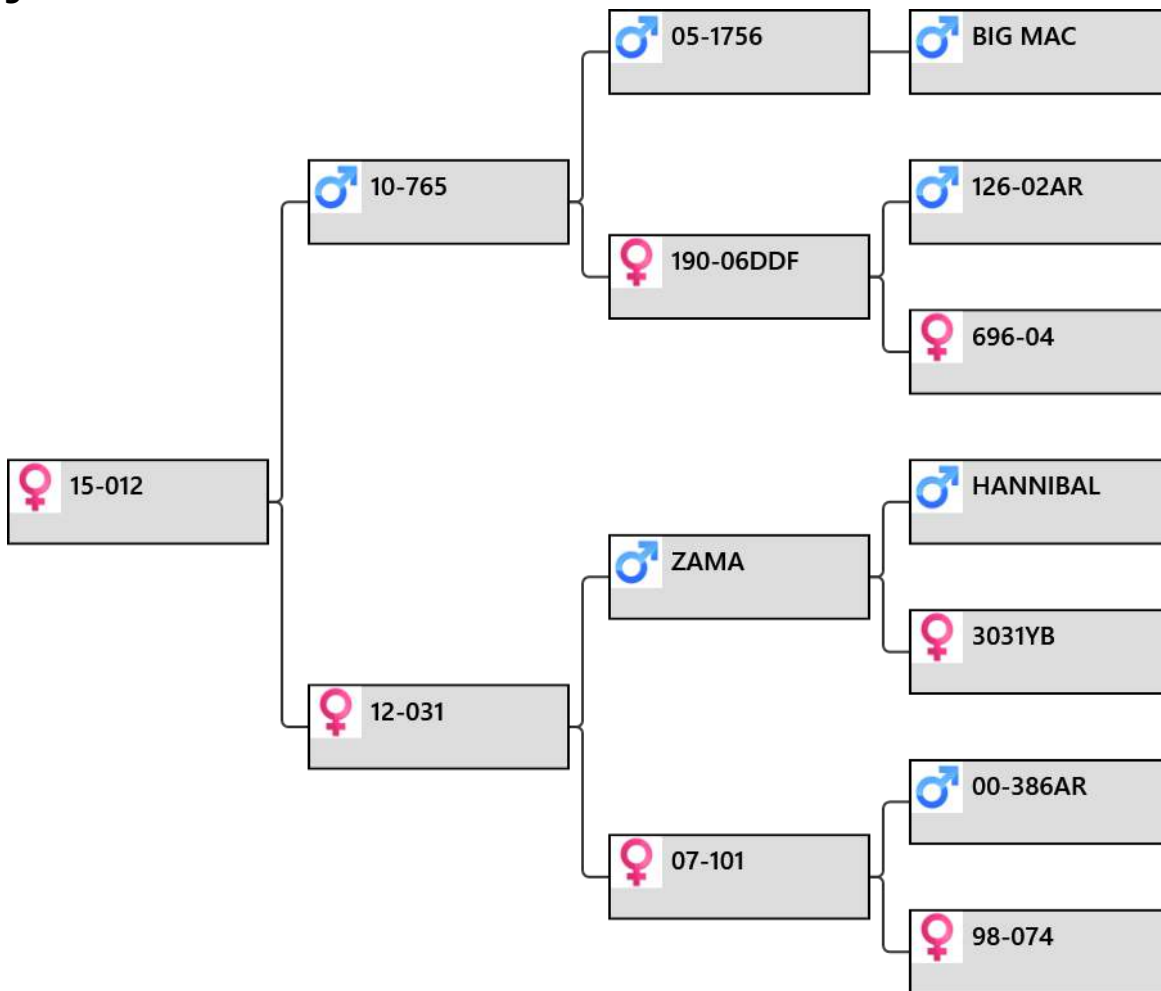

Biography:

12-15 by 765-10 7.8kg SA 2yr & 11.8kg SS 5yr
 31-12 is by Zama 12.2 kg SA & Supreme Champion, 31-12 no sons yet
 101-07 a son cutting 4.05kg @ 2yr

Sale weight: Price: Buyer:

lot # 43 – Yearling hind

**Altrive
Red Deer**



performance recorded since 1985

Yearling Hind sale 2017

Animal: **15-013**

Birthdate: 2015

Weigh Date **Weight**

5/04/2016 53 kg

28/11/2016 92 kg

Pedigree:

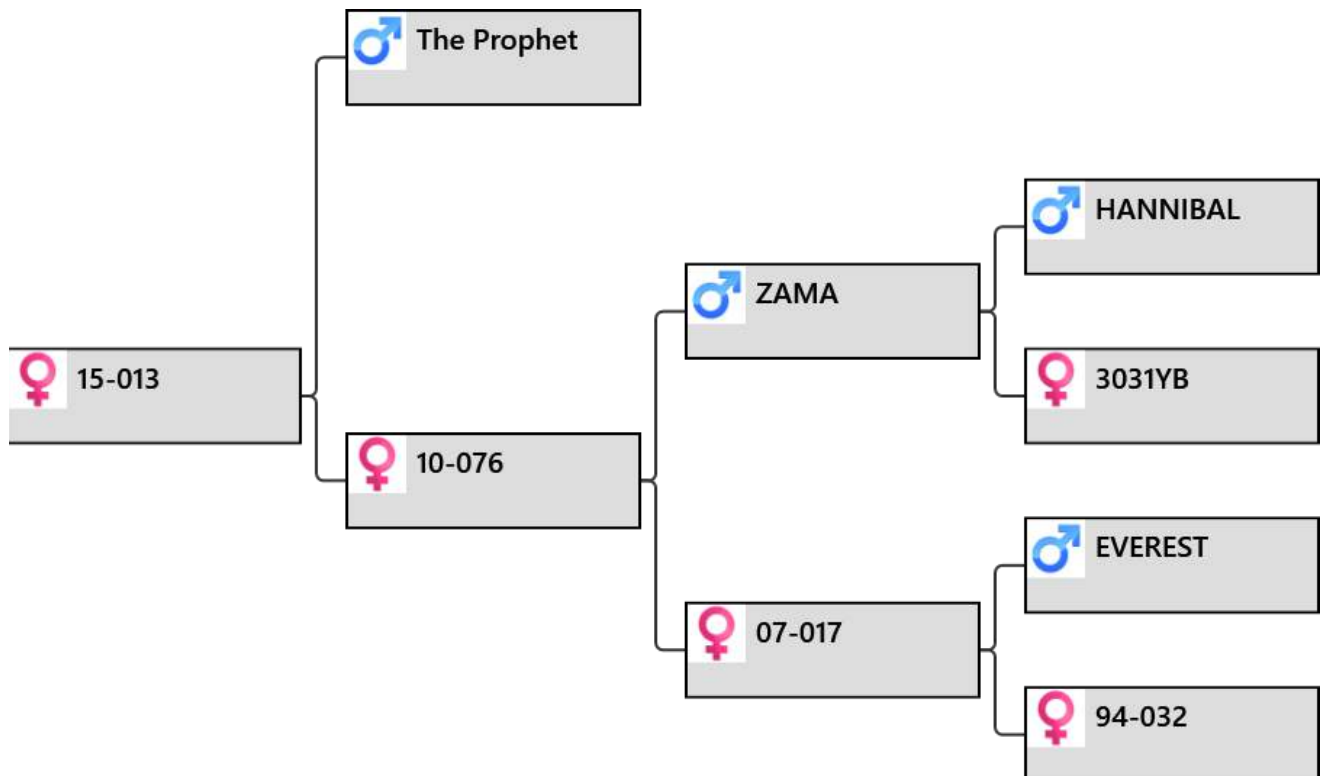

Biography:

13-15 by The Prophet 10.5kg & Supreme Champion owned by Lindsay Tayles. Two of his sons bred by Lindsay took 10th place in the 3yr 2016 and 7th in 5yr 2016.

76-10 a Zama 12.2kg SA daughter. 76-10 no sons velveted yet.

17-07 by Everest 12.25kg SA. 17-07 2 sons cutting 3.8 and 3.65kg @ 2yr

32-94 dam of a sire used in stud

Sale weight:

Price:

Buyer:



lot # 44 – Yearling hind

Animal: **15-014**

Birthdate: 2015

Weigh Date	Weight
5/04/2016	62 kg
28/11/2016	90 kg

Pedigree:

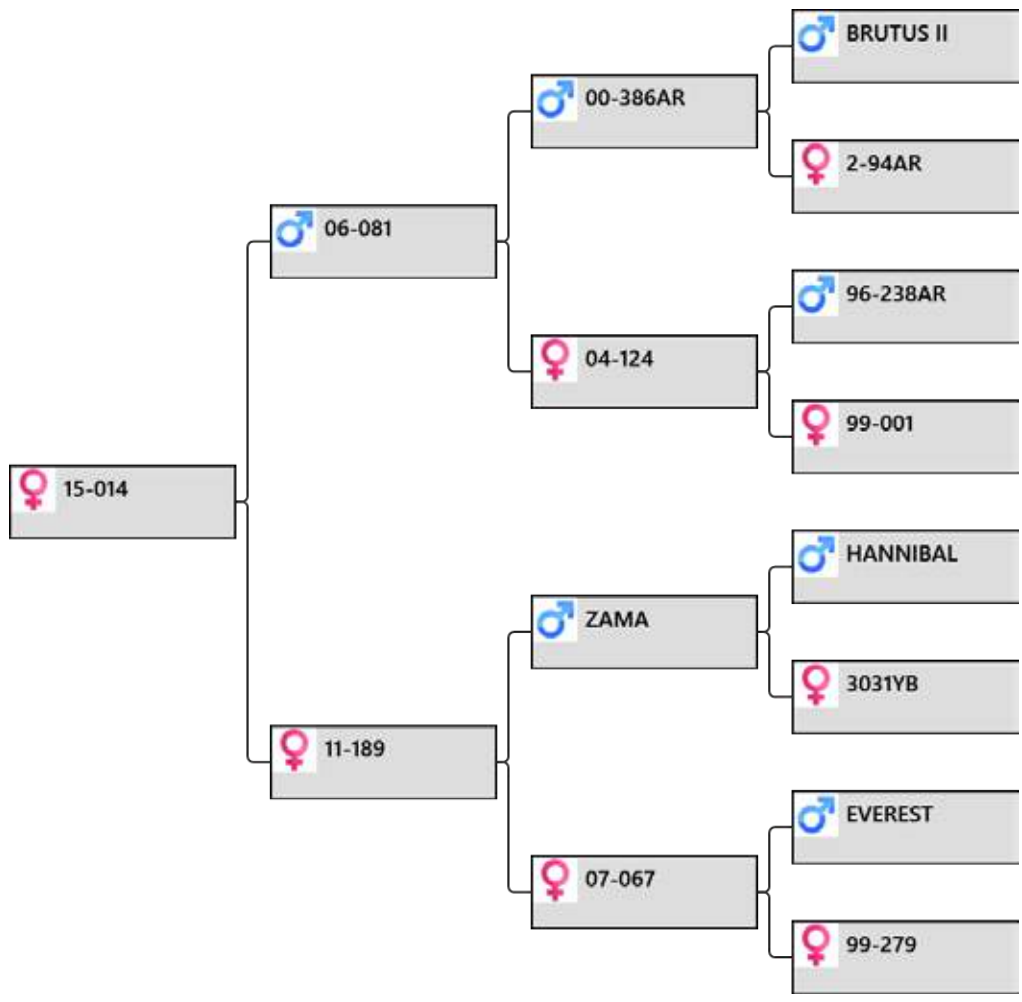

Biography:

14-15 by 81-06 sire of lot 1 2014 \$20,000
 189-11 by Supreme Champ Zama. She has 2 daughters & a son cutting 3.9kg @ 2yr
 Everest daughter 67-07 has 4 daughters & a son cutting 4kg @ 2yr
 279-99 is out of 67-92 with a son used in stud and her dam 9-90 two sons used in stud

Sale weight: Price: Buyer:

lot # 45 – Yearling hind

**Altrive
Red Deer**

performance recorded since 1985

Yearling Hind sale 2017

Animal: **15-023**

Birthdate: 2015

Weigh Date **Weight**

5/04/2016 63 kg

28/11/2016 90 kg

Pedigree:

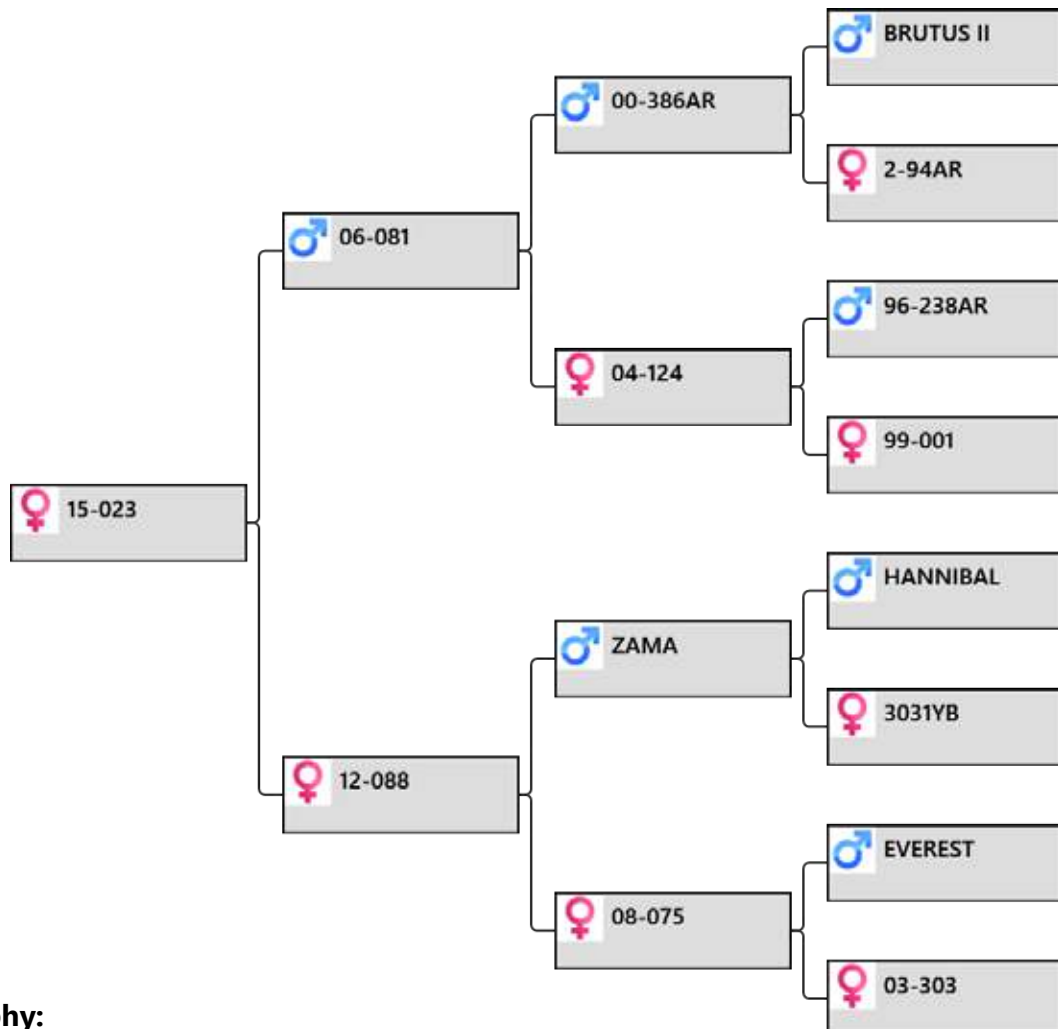

Biography:

23-15 is by 81-06 who has some very good sons in this catalogue

88-12 no sons yet.

75-08 only bred daughters

81-06, Everest & Zama all top proven sires

The only son in her pedigree is out of

303-03 and he cut 5.75kg @ 2yr.

Sale weight:

Price:

Buyer:



lot # 46 – Yearling hind

 <p>performance recorded since 1985 Yearling Hind sale 2017</p>	<p>Animal: 15-029</p> <hr/> <p>Birthdate: 2015</p> <table border="1"> <thead> <tr> <th>Weigh Date</th> <th>Weight</th> </tr> </thead> <tbody> <tr> <td>5/04/2016</td> <td>62 kg</td> </tr> <tr> <td>28/11/2016</td> <td>86 kg</td> </tr> </tbody> </table>	Weigh Date	Weight	5/04/2016	62 kg	28/11/2016	86 kg
	Weigh Date	Weight					
5/04/2016	62 kg						
28/11/2016	86 kg						

Pedigree:

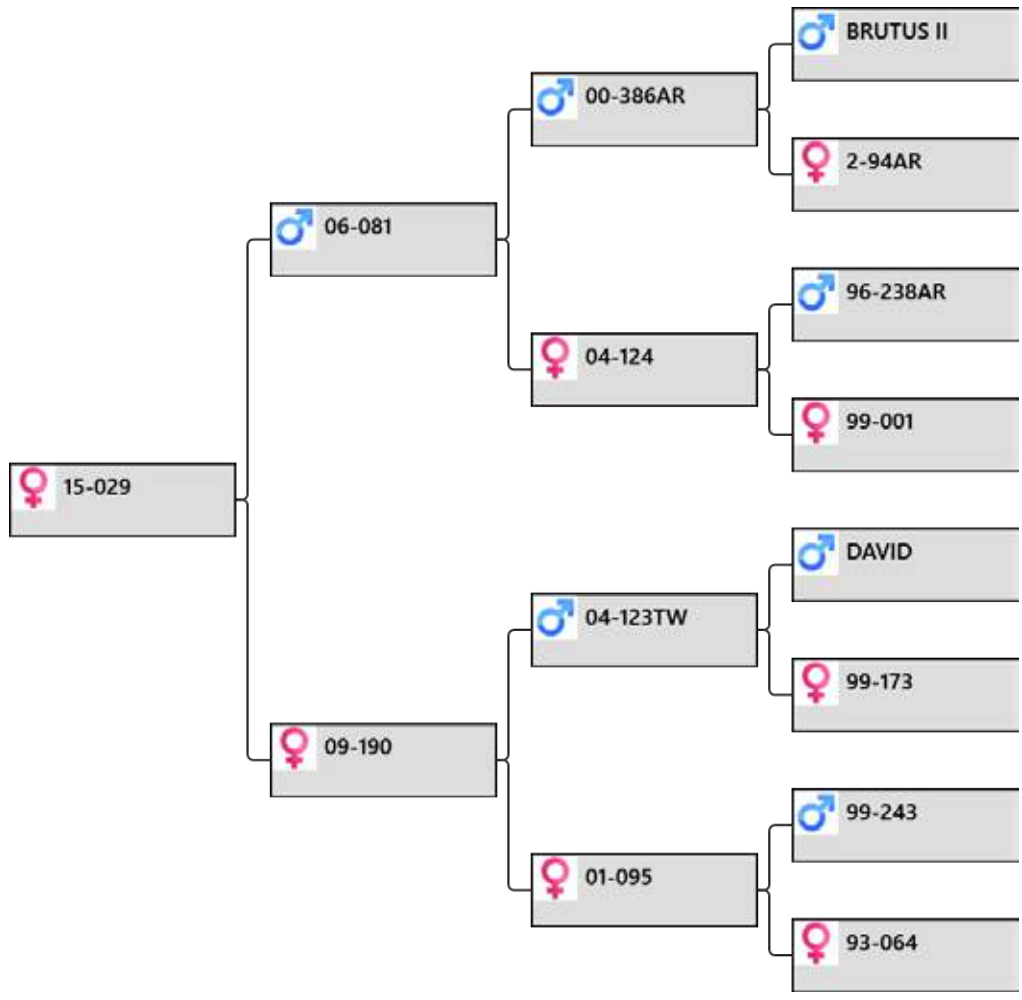

Biography:

29-15 another top daughter of 81-06
 190-09, 4 daughters & a son cutting 4.2 @ 2yr
 95-01 a son sold 2015 \$4,500. Sons cutting 4kg, 4.8kg, 3.8kg and 3.75kg @ 2yr.
 64-93 a son sold as a trophy.

Sale weight: Price: Buyer:

lot # 47 – Yearling hind



Animal: **15-031**

Birthdate: 2015

Weigh Date	Weight
5/04/2016	60 kg
28/11/2016	79 kg

Pedigree:

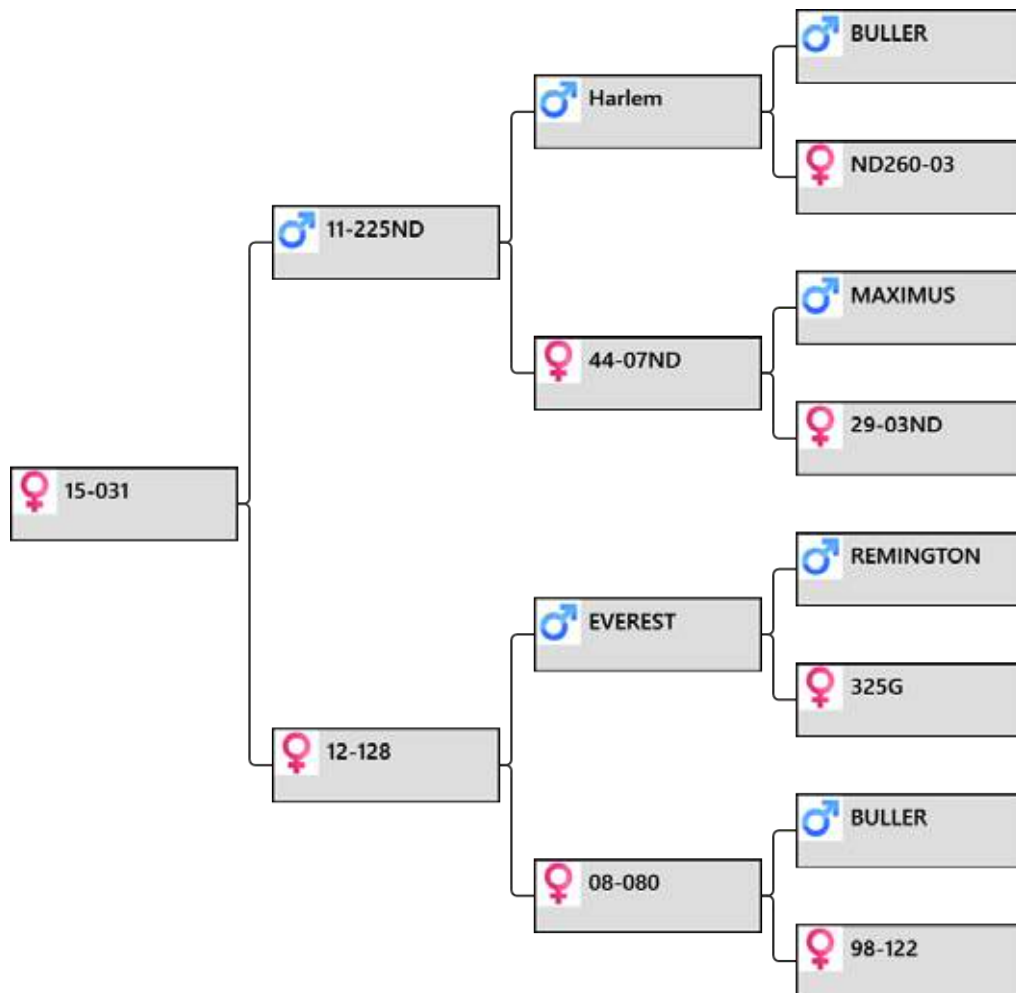

Biography:

31-15 by ND 225-11 12kg SA 5yr
 128-12 an Everest daughter who has 2 daughters so far.
 80-08 dam of lot one 2015 \$25,000
 122-98 dam of 2 sons sold as sires and Grand dam of 2yr champion sold Joe Crowley & G Dam of lot 1 2015 and 2016. A very good pedigree with Buller there too.

Sale weight:

Price:

Buyer:



lot # 48 – Yearling hind

 <p>performance recorded since 1985</p> <p>Yearling Hind sale 2017</p>	<p>Animal: 15-032</p> <hr/> <p>Birthdate: 2015</p> <table border="1"> <thead> <tr> <th>Weigh Date</th> <th>Weight</th> </tr> </thead> <tbody> <tr> <td>5/04/2016</td> <td>54 kg</td> </tr> <tr> <td>28/11/2016</td> <td>83 kg</td> </tr> </tbody> </table>	Weigh Date	Weight	5/04/2016	54 kg	28/11/2016	83 kg
	Weigh Date	Weight					
5/04/2016	54 kg						
28/11/2016	83 kg						

Pedigree:

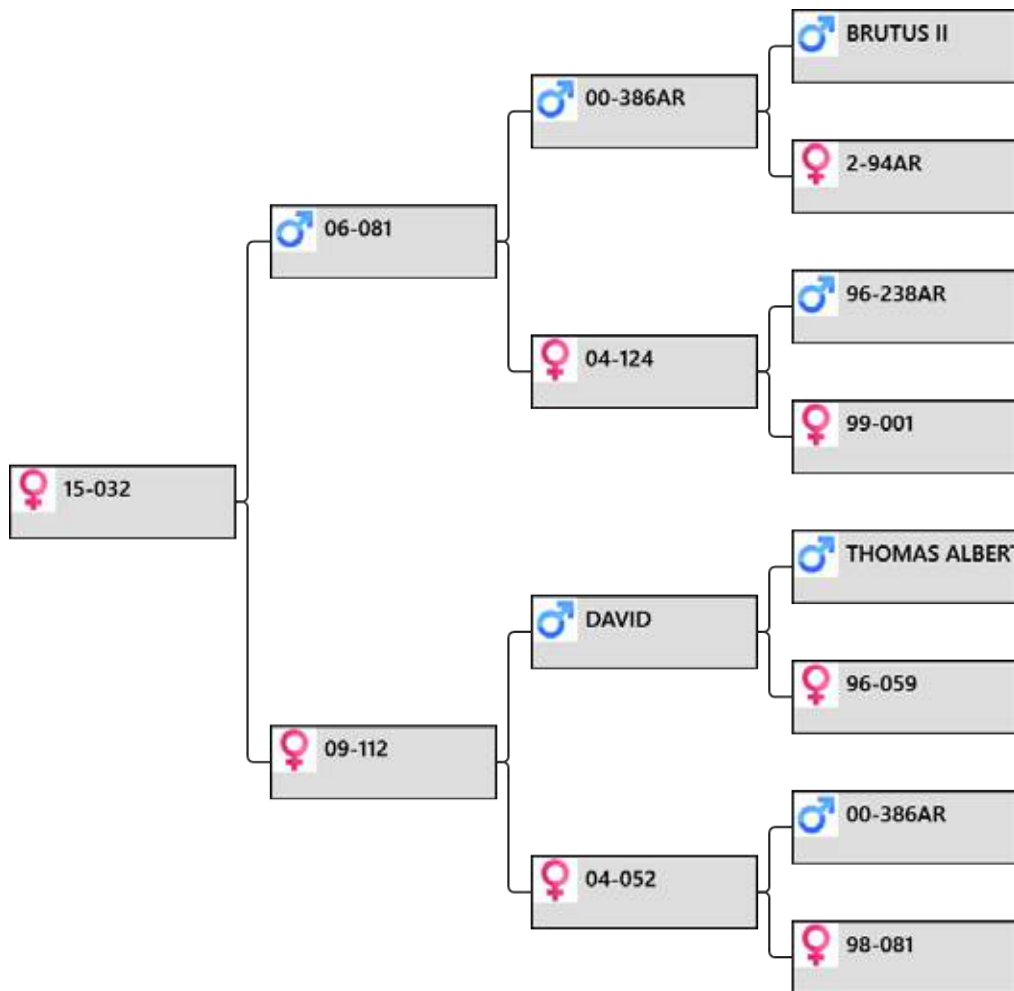

Biography:

32-15 by 81-06 a massive 18.4kg SS velvet over a David daughter 11kg SA
 52-04 sons cutting 4.4kg, 5,3kg and 4.9kg @ 2yr. One of these sons then sold as
 450 SCI trophy stag.
 81-98 a 2yr son cutting 4kg.

Sale weight: Price: Buyer:

lot # 49 – Yearling hind

**Altrive
Red Deer**

performance recorded since 1985

Yearling Hind sale 2017

Animal: **15-037**

Birthdate: 2015

Weigh Date **Weight**

5/04/2016 62 kg

28/11/2016 85 kg

Pedigree:

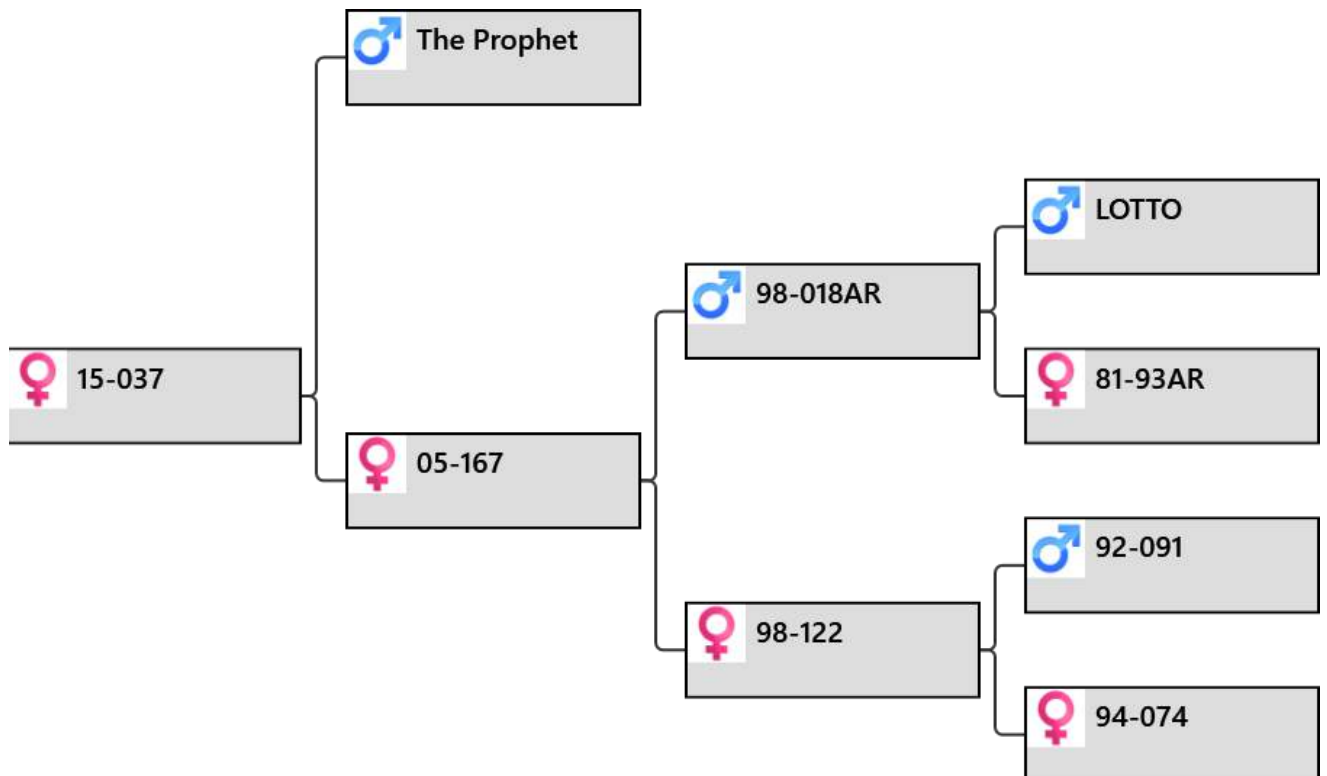

Biography:

37-15 by The Prophet 10.5 kg Supreme Champion

167-05 5 daughters and 2 sons cutting 4.15 & 4.2kg @ 2yr.

Grand dam once again is 122-98 G dam of 2yr Champiin 53-07 sold \$17,000 and

Grand dam of lot one 2015 \$25,000, and lot 1 2016 \$67,000

plus she is dam of lot ten 2013 \$8,800. Top breeding.

Sale weight:

Price:

Buyer:



lot # 50 – Yearling hind

 <p>performance recorded since 1985</p> <p>Yearling Hind sale 2017</p>	<p>Animal: 15-040</p> <hr/> <p>Birthdate: 2015</p> <table border="1"> <thead> <tr> <th>Weigh Date</th> <th>Weight</th> </tr> </thead> <tbody> <tr> <td>5/04/2016</td> <td>59 kg</td> </tr> <tr> <td>28/11/2016</td> <td>89 kg</td> </tr> </tbody> </table>	Weigh Date	Weight	5/04/2016	59 kg	28/11/2016	89 kg
	Weigh Date	Weight					
5/04/2016	59 kg						
28/11/2016	89 kg						

Pedigree:

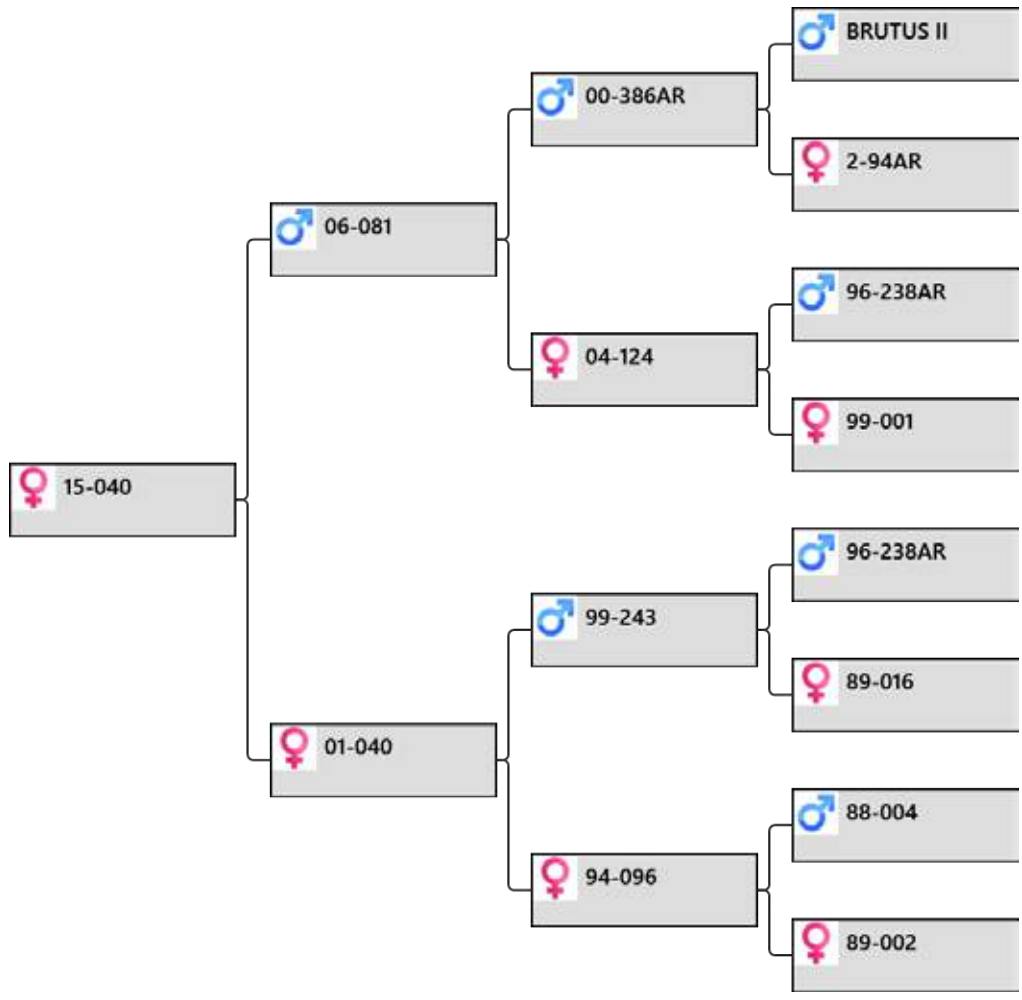

Biography:

40-15 by 81-06 18.4kg SS velvet. He has left some very good 3yr olds this year as you can see in this catalogue.

40-01 an older hind but a good one and still in our herd.

She has bred 2yr sons cutting 5.05, 4.15, 3.75 and 3.65

Sale weight:

Price:

Buyer:

lot # 51 – Yearling hind



Animal: **15-047**

Birthdate: 2015

Weigh Date	Weight
5/04/2016	64 kg
28/11/2016	96 kg

Pedigree:

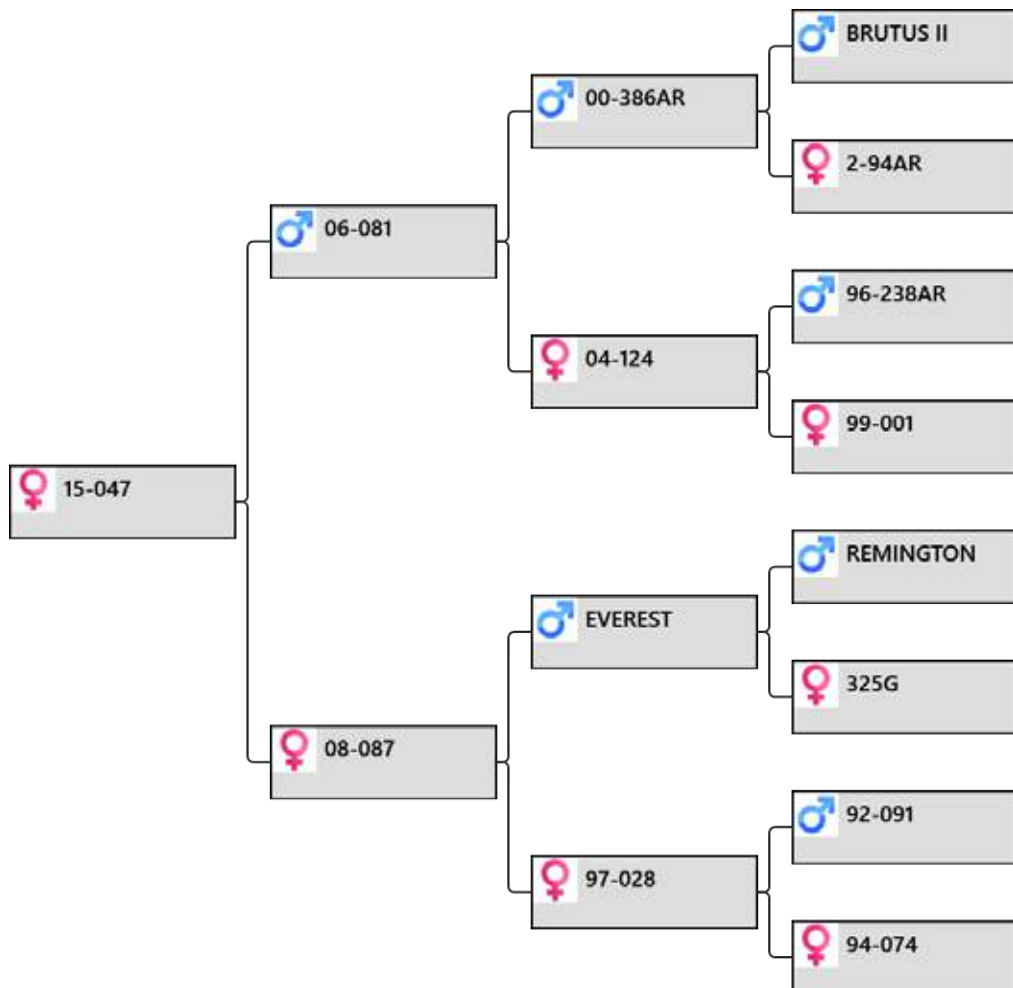

Biography:

47-15 good sized hind by 81-06
 87-08 had a son sold 2015 \$4500
 28-97 a son sold as a sire and two 2yr old stags cutting 4.4 and 4kg
 74-94 is the dam of 122-98 the top hind who appears in a lot of top stags pedigrees

Sale weight:

Price:

Buyer:



lot # 52 – Yearling hind

 <p>performance recorded since 1985 Yearling Hind sale 2017</p>	<p>Animal: 15-049</p> <hr/> <p>Birthdate: 2015</p> <table border="1"> <thead> <tr> <th>Weigh Date</th> <th>Weight</th> </tr> </thead> <tbody> <tr> <td>5/04/2016</td> <td>56 kg</td> </tr> <tr> <td>28/11/2016</td> <td>90 kg</td> </tr> </tbody> </table>	Weigh Date	Weight	5/04/2016	56 kg	28/11/2016	90 kg
	Weigh Date	Weight					
5/04/2016	56 kg						
28/11/2016	90 kg						

Pedigree:

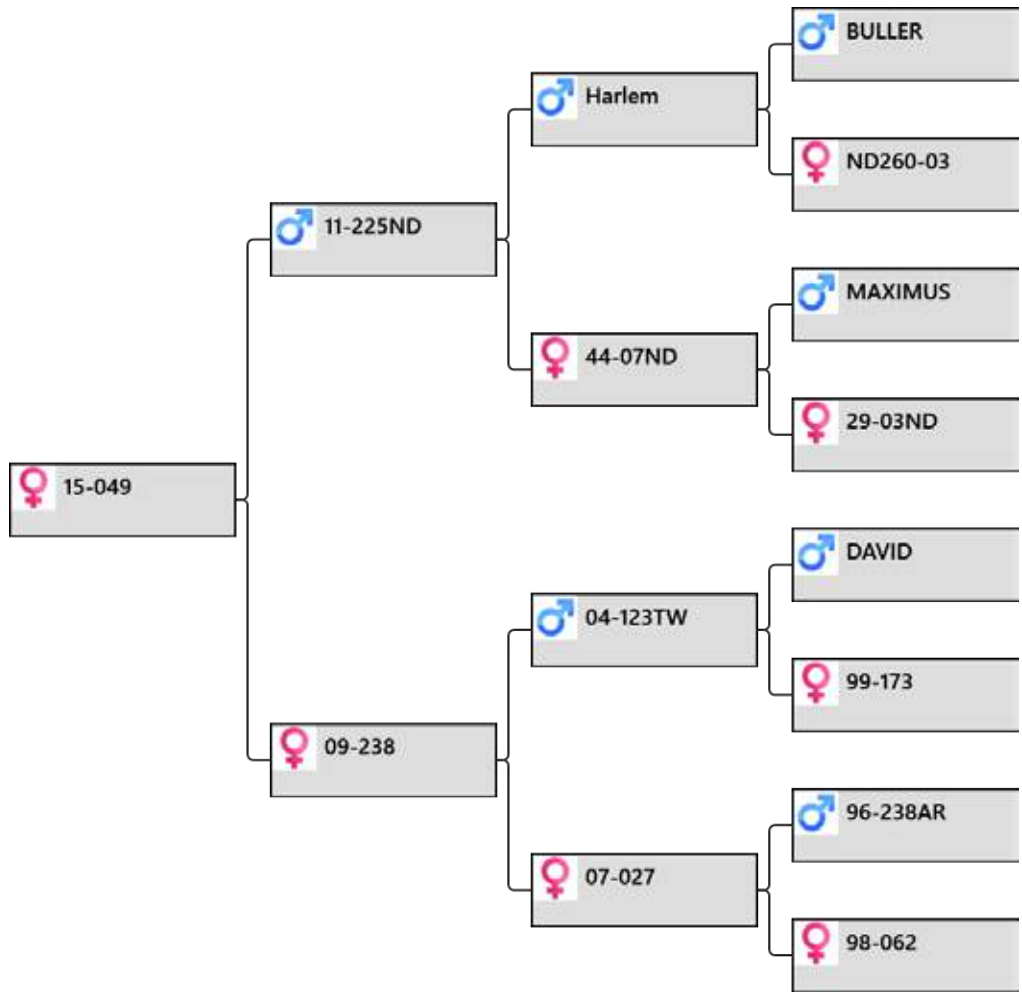

Biography:

49-15 sired by 225 -11 12kg SA 5yr
 238-09 only one stag velveted so far= 4.75kg @ 2yr
 27-07 had a son cut 5.2 kg @ 2yr

Sale weight: Price: Buyer:

lot # 53 – Yearling hind



Animal: **15-058**

Birthdate: 2015

Weigh Date	Weight
5/04/2016	70 kg
28/11/2016	105 kg

Pedigree:

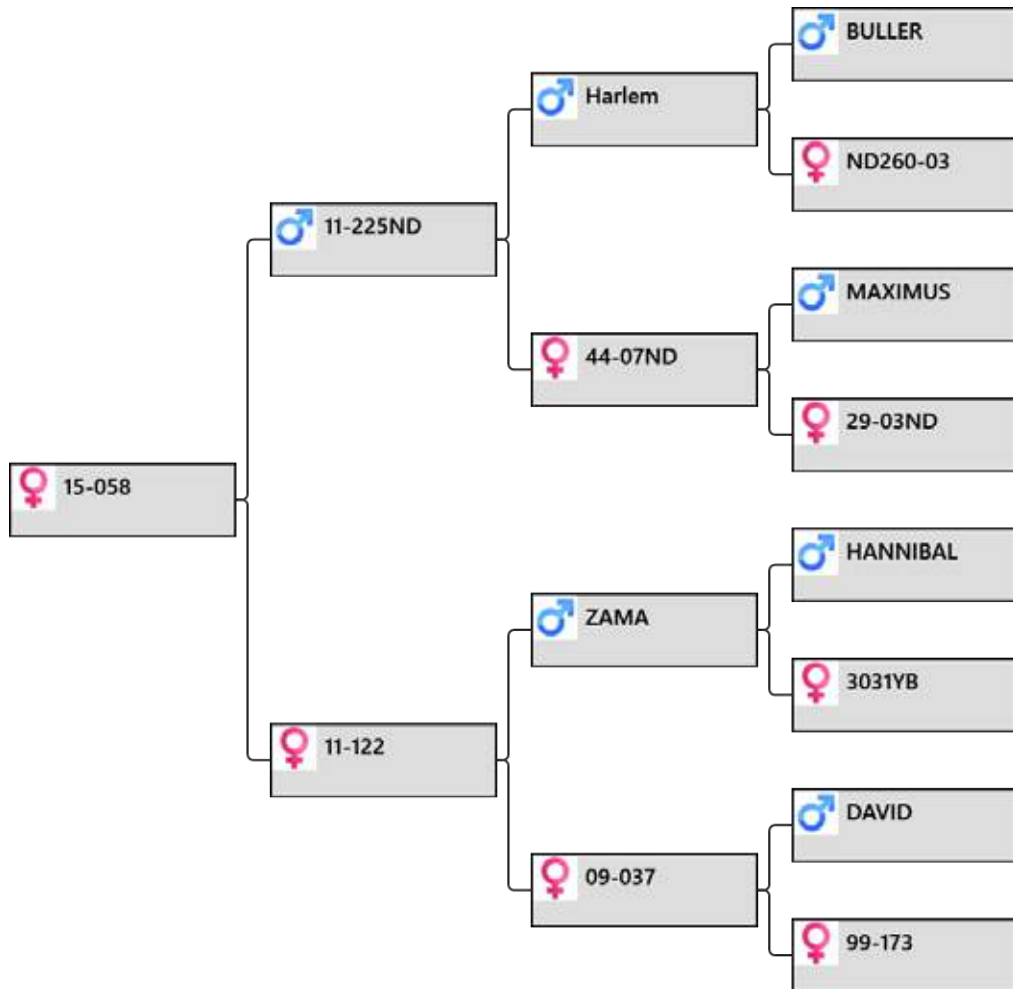

Biography:

85-15 by 225-11 12kg SA 5yr

122-11 by Zama 12.25kg SA

37-07 a son cutting 4.25kg @ 2yr and she is a full sister to 123-04 502 IOA @ 4yr

Sale weight:

Price:

Buyer:



lot # 54 – Yearling hind

 <p>performance recorded since 1985 Yearling Hind sale 2017</p>	<p>Animal: 15-064</p> <hr/> <p>Birthdate: 2015</p> <table border="1"> <thead> <tr> <th>Weigh Date</th> <th>Weight</th> </tr> </thead> <tbody> <tr> <td>5/04/2016</td> <td>62 kg</td> </tr> <tr> <td>28/11/2016</td> <td>97 kg</td> </tr> </tbody> </table>	Weigh Date	Weight	5/04/2016	62 kg	28/11/2016	97 kg
	Weigh Date	Weight					
5/04/2016	62 kg						
28/11/2016	97 kg						

Pedigree:

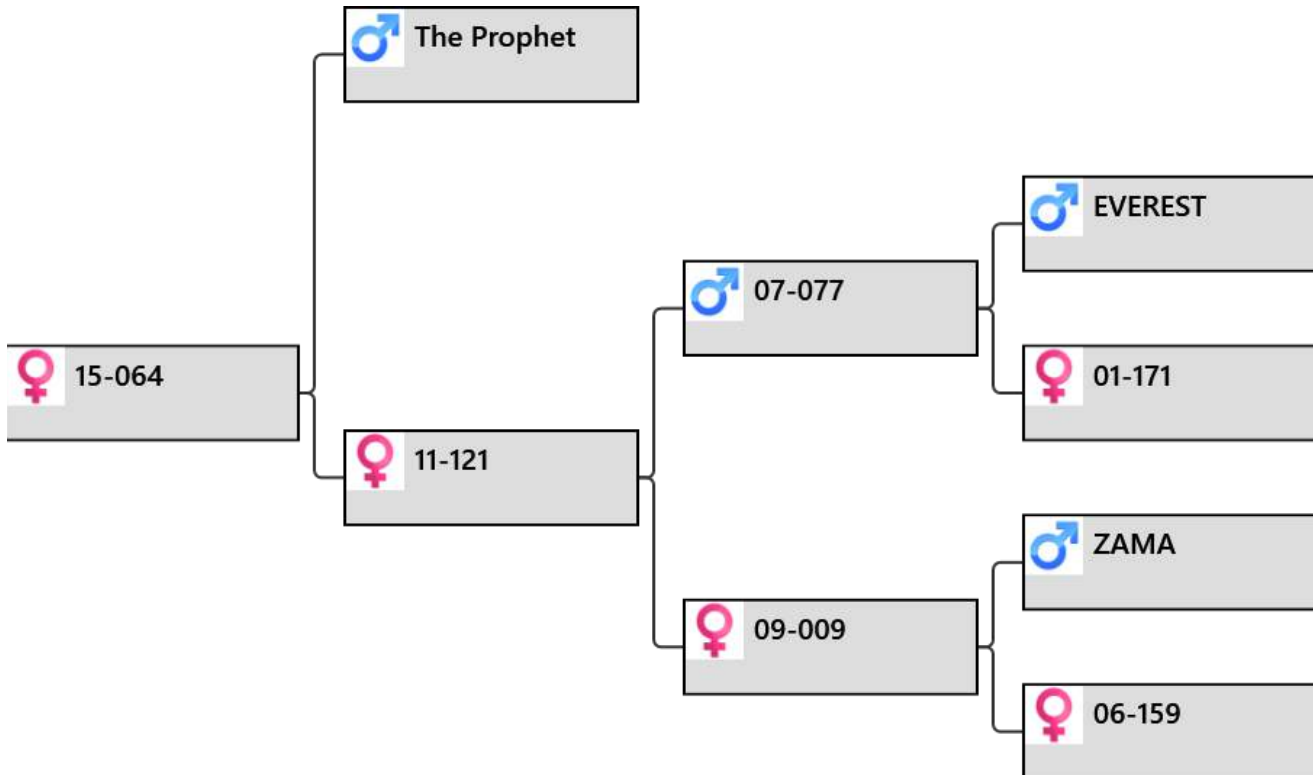

Biography:

The Prophet 2013 supreme champion sire of 64-15
 121-11 sired by 77-07, sold for \$15,000
 9-09 daughter of Zama 12.25kg SA
 She has no sons velveted yet
 159-06 no sons

Sale weight: Price: Buyer:

lot # 55 – Yearling hind



Animal: **15-074**

Birthdate: 2015

Weigh Date	Weight
5/04/2016	67 kg
28/11/2016	87 kg

Pedigree:

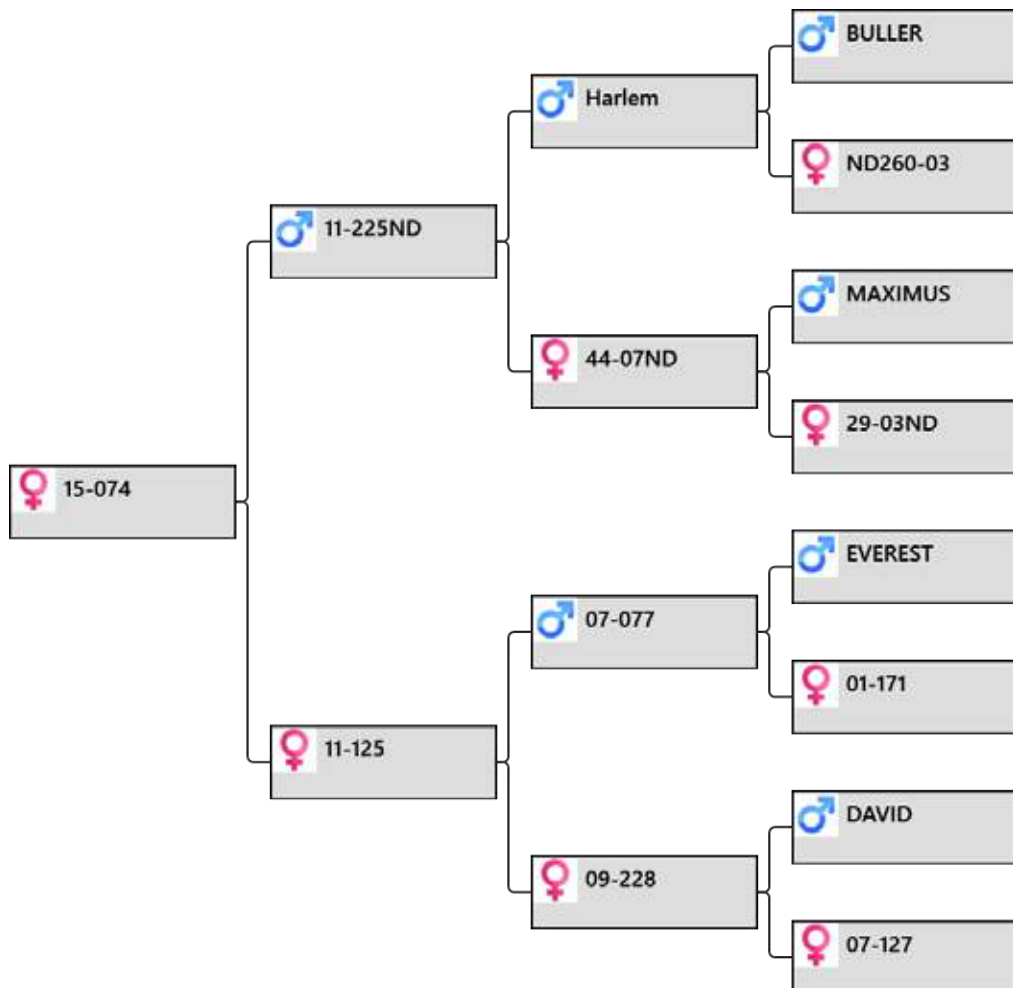

Biography:

Now 225-11, 12kg SA has died, there will not be many of his daughters offered for sale.
 125-11 by 77-07 10kg SA 6yr
 228-09 has 6 daughters, no sons
 127-07 dam of lot 3 2015 \$9500

Sale weight:

Price:

Buyer:



lot # 56 – Yearling hind

Altrive Red Deer

performance recorded since 1985

Yearling Hind sale 2017

Animal: **15-076**

Birthdate: 2015

Weigh Date	Weight
5/04/2016	62 kg
28/11/2016	95 kg

Pedigree:

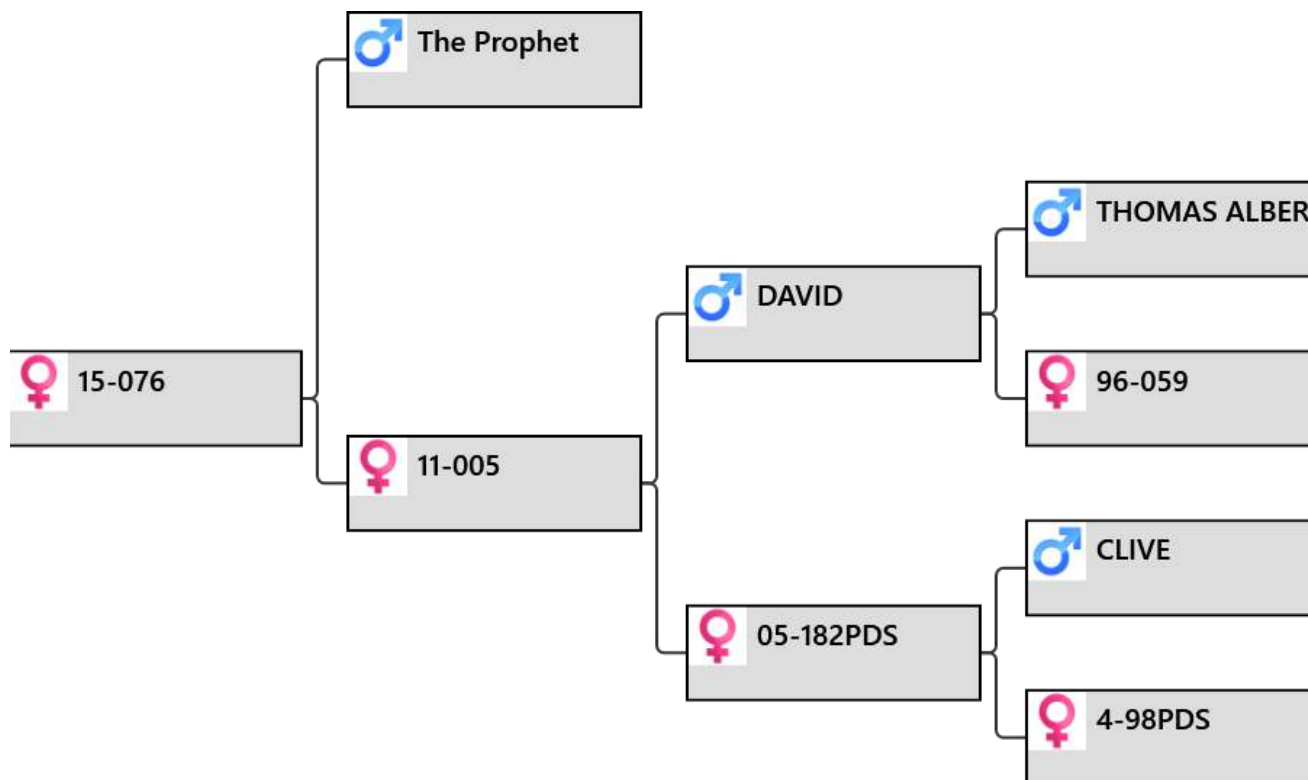

Biography:

A Prophet daughter out of 5-11 by David 11kg SA
 182-05 sons cutting 4.65 and 4.3 kg @ 2yr with one
 being sold as a trophy 470 SCI

Sale weight:

Price:

Buyer:

lot # 57 – Yearling hind

**Altrive
Red Deer**

performance recorded since 1985

Yearling Hind sale 2017

Animal: **15-077**

Birthdate: 2015

Weigh Date **Weight**

5/04/2016 71 kg

28/11/2016 93 kg

Pedigree:

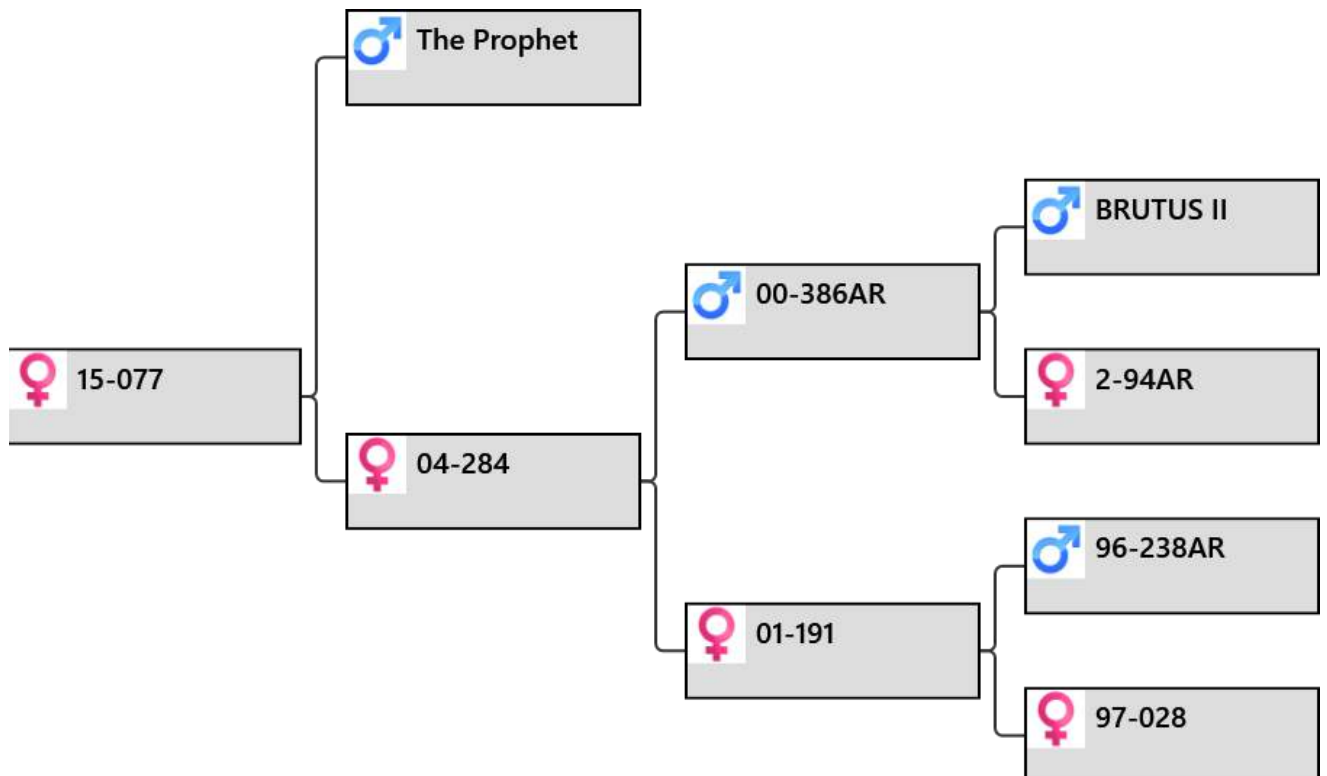

Biography:

77-15 a Prophet daughter

284-04 sons cutting 4.25 & 4.2kg @ 2yr with one sold 2014 for \$4800.

A daughter of 284-04 produced a son cutting 7.35kg @ 3yr

28-97 sons cutting 4.4 & 4.0kg @ 2yr with one sold as a sire

Sale weight:

Price:

Buyer:



lot # 58 – Yearling hind

 <p>Altrive Red Deer performance recorded since 1985 Yearling Hind sale 2017</p>	<p>Animal: 15-081</p> <hr/> <p>Birthdate: 2015</p> <table border="1"> <thead> <tr> <th>Weigh Date</th> <th>Weight</th> </tr> </thead> <tbody> <tr> <td>5/04/2016</td> <td>64 kg</td> </tr> <tr> <td>28/11/2016</td> <td>87 kg</td> </tr> </tbody> </table>	Weigh Date	Weight	5/04/2016	64 kg	28/11/2016	87 kg
	Weigh Date	Weight					
5/04/2016	64 kg						
28/11/2016	87 kg						

Pedigree:

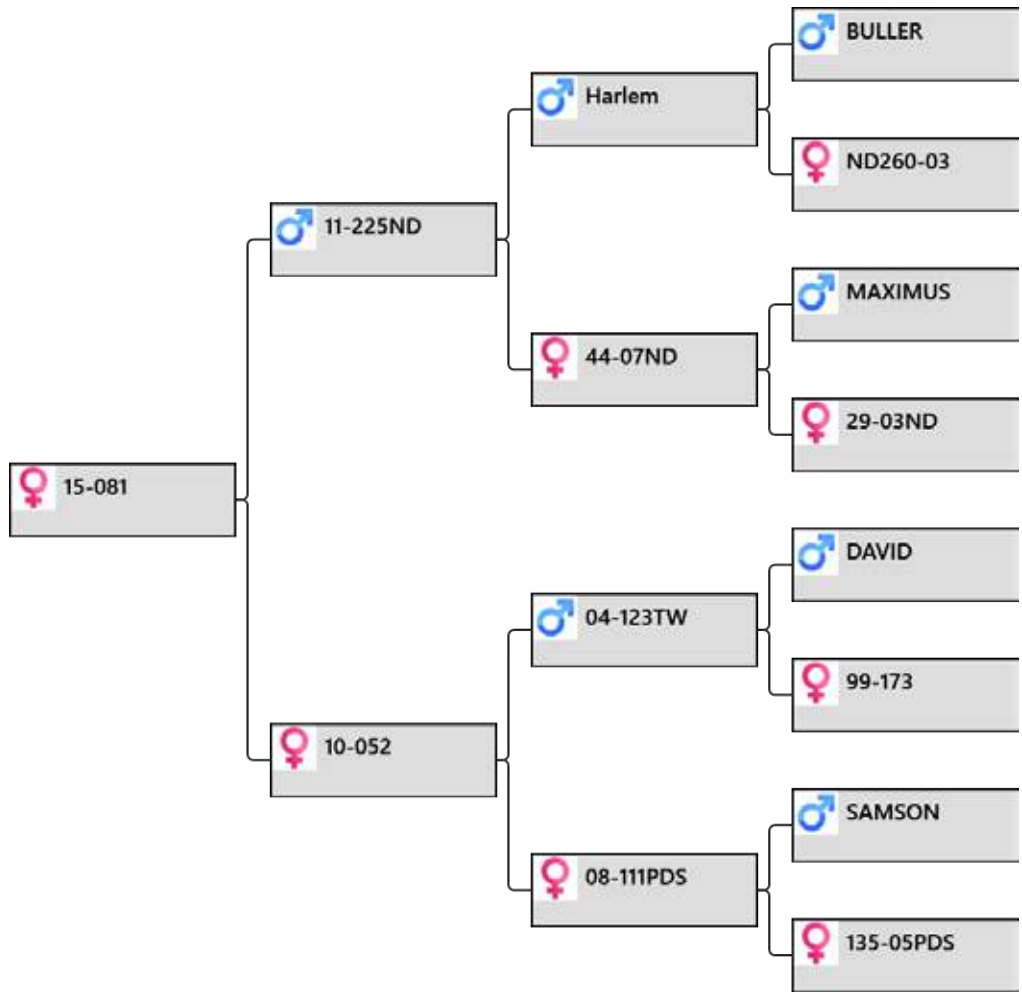

Biography:

81-15 sired by ND 225-11 12kg SA @ 5yr
 52-10 embryo sister to 3 sons of Pelorus 111-08. They cut 4.6, 4.2 & 3.85kg and
 the 3 were sold at 2013 sale
 PDS 135-05 a Charlie Mac daughter

Sale weight: _____ Price: _____ Buyer: _____

lot # 59 – Yearling hind

 <p>Altrive Red Deer</p> <p>performance recorded since 1985</p> <p>Yearling Hind sale 2017</p>	Animal: 15-082					
	Birthdate: 2015					
	<table border="1"> <thead> <tr> <th>Weigh Date</th> <th>Weight</th> </tr> </thead> <tbody> <tr> <td>5/04/2016</td> <td>64 kg</td> </tr> <tr> <td>28/11/2016</td> <td>91 kg</td> </tr> </tbody> </table>	Weigh Date	Weight	5/04/2016	64 kg	28/11/2016
Weigh Date	Weight					
5/04/2016	64 kg					
28/11/2016	91 kg					

Pedigree:

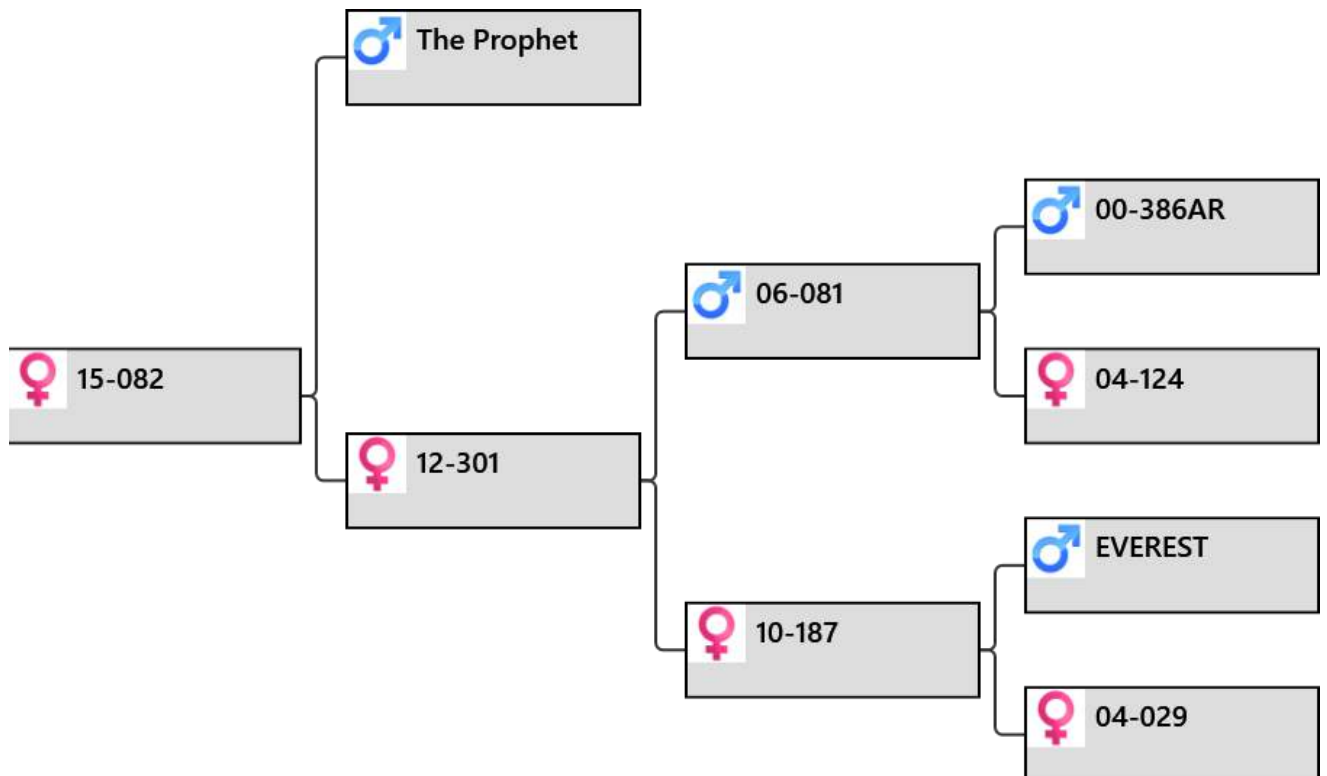

Biography:

82-15 by The Prophet Supreme Champion 2013

301-12 by 81-06 18.4kg SS velvet @ 10yr. 81-06 has 30 & 33 cm pedicles.

187-10 an Everest Daughter with only daughters so far.

29-04 sons cutting 5.2, 4.1, 4.0, 4.7 & 4.2kg @ 2yr. two of these sold as sires

Lot 14 2016 \$7,500, lot 13 2015 \$9,500

Sale weight:

Price:

Buyer:



lot # 60 – Yearling hind

 <p>Altrive Red Deer performance recorded since 1985 Yearling Hind sale 2017</p>	<p>Animal: 15-083</p> <hr/> <p>Birthdate: 2015</p> <table border="1"> <thead> <tr> <th>Weigh Date</th> <th>Weight</th> </tr> </thead> <tbody> <tr> <td>5/04/2016</td> <td>67 kg</td> </tr> <tr> <td>28/11/2016</td> <td>91 kg</td> </tr> </tbody> </table>	Weigh Date	Weight	5/04/2016	67 kg	28/11/2016	91 kg
	Weigh Date	Weight					
5/04/2016	67 kg						
28/11/2016	91 kg						

Pedigree:

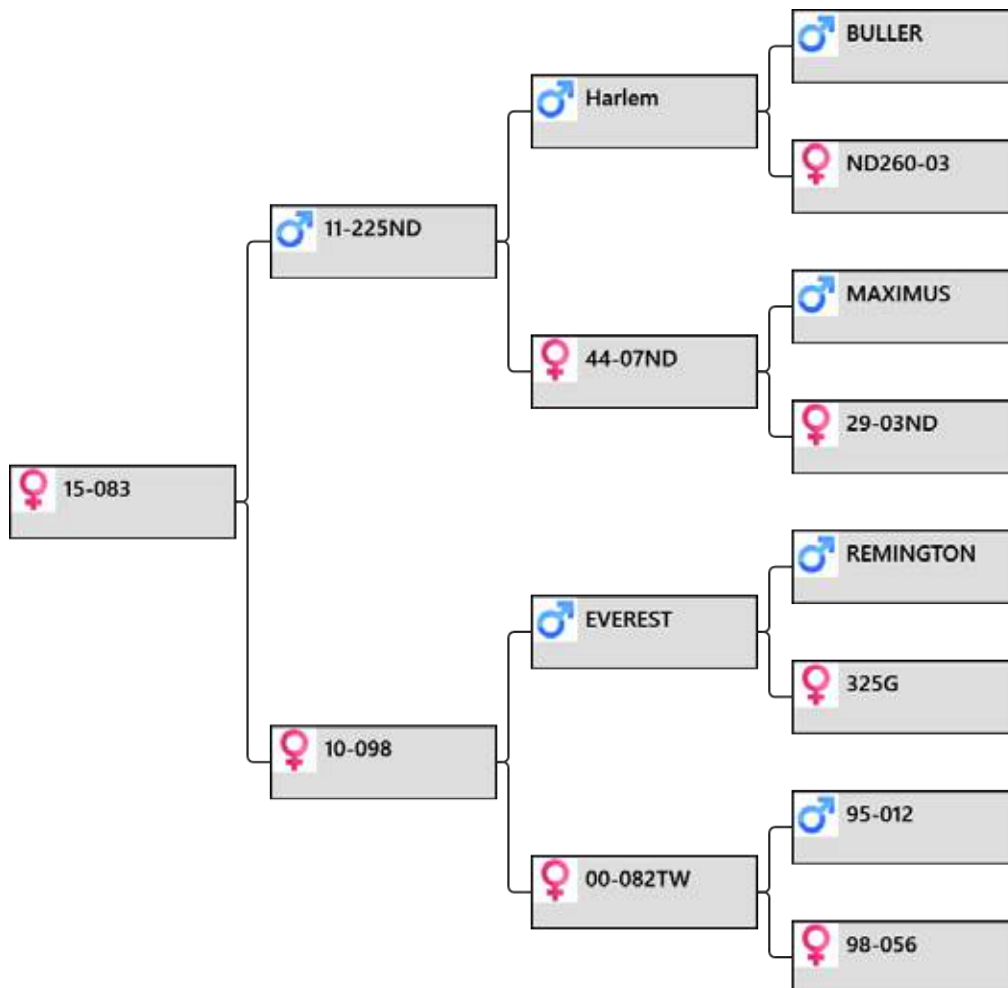

Biography:

83-15 by 225-11 purchased with Arawata Stud for \$40,000
 98-10 an Everest daughter with a son cutting 4kg @ 2yr
 82-00 sons sold for \$15,000 and \$4000

Sale weight:

Price:

Buyer:

lot # 61 – Yearling hind

**Altrive
Red Deer**

performance recorded since 1985

Yearling Hind sale 2017

Animal: **15-084**

Birthdate: 2015

Weigh Date **Weight**

5/04/2016 68 kg

28/11/2016 89 kg

Pedigree:

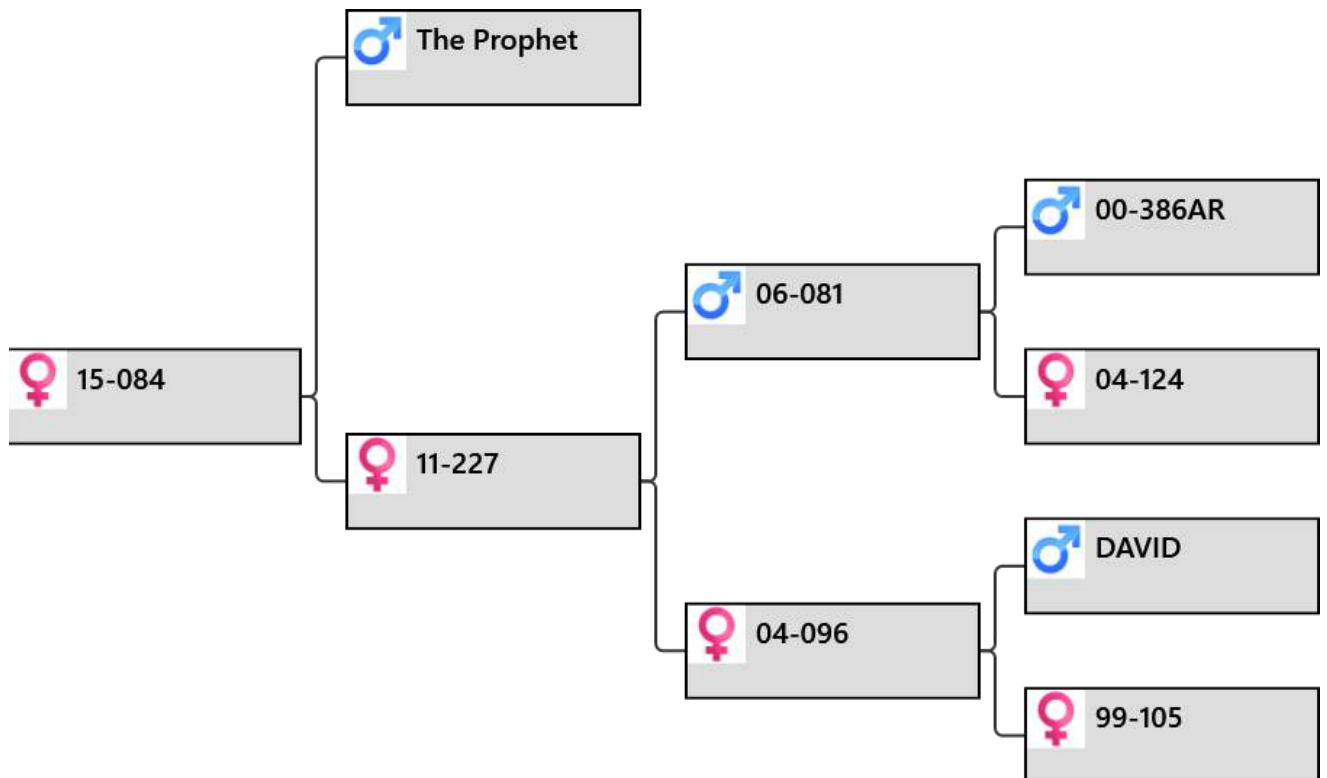

Biography:

84-15 by The Prophet 10.6 kg

227-11 by 81-06 who has some very good sons in this catalogue.

227-11 no sons velveted yet

96-04 by David 11kg SA. 96-04 a son cutting 3.8kg @ 2yr and 5 daughters.

Sale weight:

Price:

Buyer:



lot # 62 – Yearling hind

 <p>performance recorded since 1985</p> <p>Yearling Hind sale 2017</p>	<p>Animal: 15-085</p> <hr/> <p>Birthdate: 2015</p>					
	<table border="1"> <thead> <tr> <th>Weigh Date</th> <th>Weight</th> </tr> </thead> <tbody> <tr> <td>5/04/2016</td> <td>62 kg</td> </tr> <tr> <td>28/11/2016</td> <td>85 kg</td> </tr> </tbody> </table>	Weigh Date	Weight	5/04/2016	62 kg	28/11/2016
Weigh Date	Weight					
5/04/2016	62 kg					
28/11/2016	85 kg					

Pedigree:

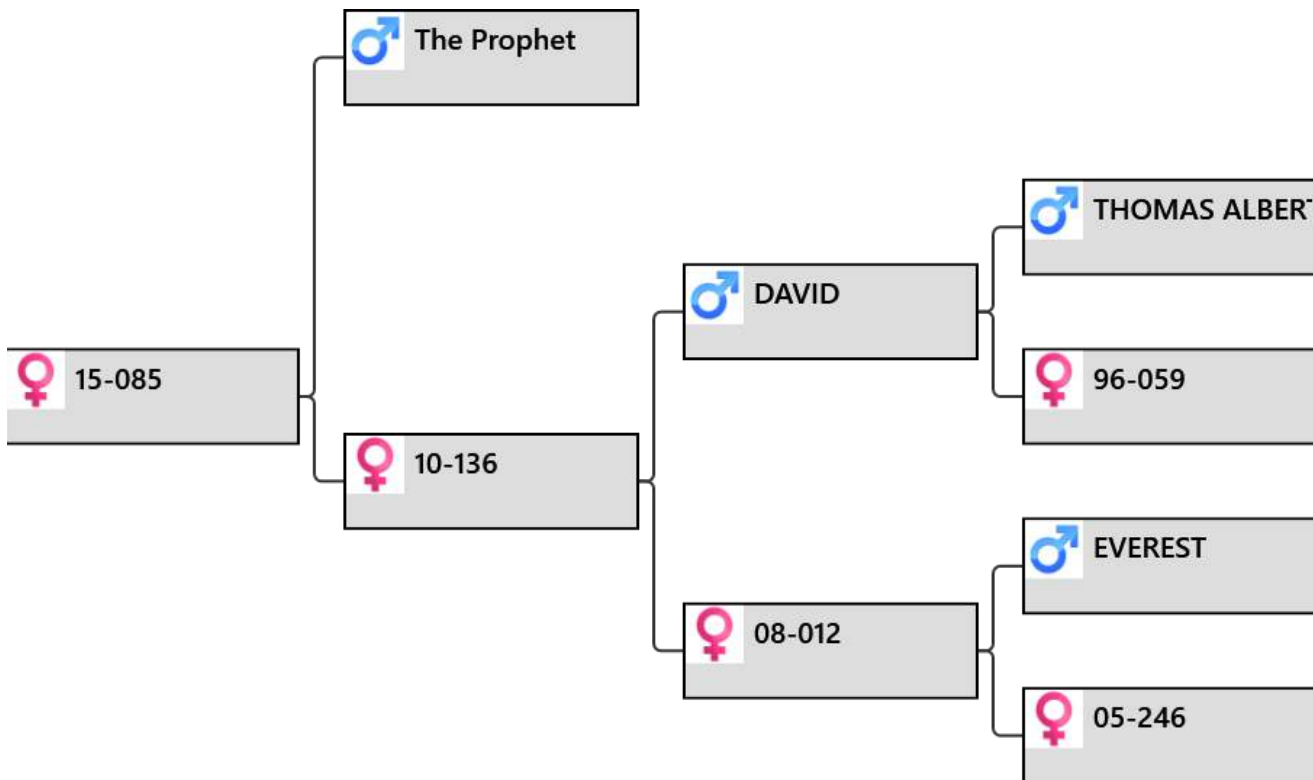

Biography:

The Prophet 10.6kg over David 11kg out of a daughter of Everest who has given us four National Champions and four 2nd placings.
246-05 sons cutting 3.8 and 4.1 @ 2yr.

Sale weight:

Price:

Buyer:

lot # 63 – Yearling hind

 <p>Altrive Red Deer</p> <p>performance recorded since 1985</p> <p>Yearling Hind sale 2017</p>	<p>Animal: 15-087</p> <hr/> <p>Birthdate: 2015</p>					
	<table border="1"> <thead> <tr> <th>Weigh Date</th> <th>Weight</th> </tr> </thead> <tbody> <tr> <td>5/04/2016</td> <td>65 kg</td> </tr> <tr> <td>28/11/2016</td> <td>79 kg</td> </tr> </tbody> </table>	Weigh Date	Weight	5/04/2016	65 kg	28/11/2016
Weigh Date	Weight					
5/04/2016	65 kg					
28/11/2016	79 kg					

Pedigree:

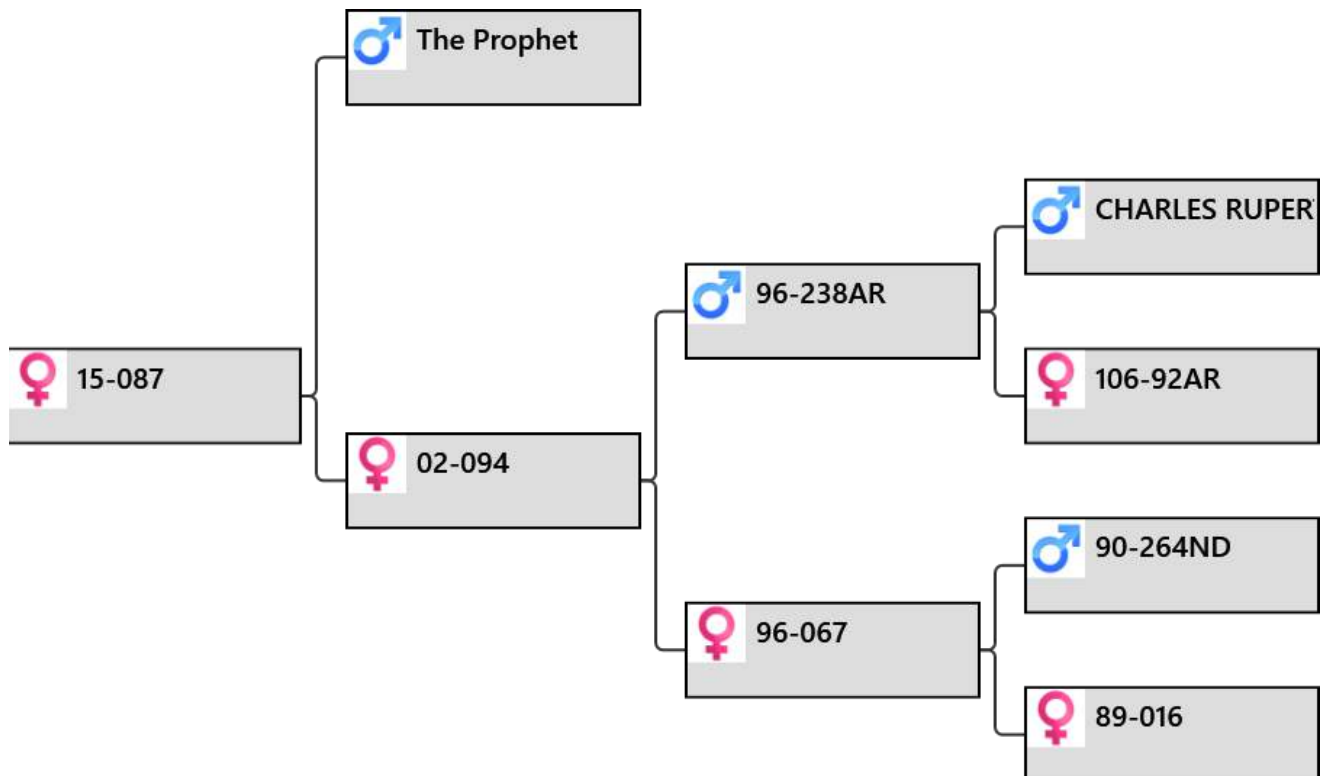

Biography:

87-15 out of older but top hind 94-02

94-02 sons cutting 5 kg and 4.8kg @ 2yr. Her daughter 29-08 a son sold \$12,500

Another daughter 30-11 sold for \$2,400

67-96 another top old hind with her daughter 271-00 breeding sons

cutting 6.1, 4.65, 5.0, 4.65 and 4.35 @ 2yr

Sale weight:

Price:

Buyer:



lot # 64 – Yearling hind

 <p>Altrive Red Deer</p> <p>performance recorded since 1985</p> <p>Yearling Hind sale 2017</p>	<p>Animal: 15-091</p> <hr/> <p>Birthdate: 2015</p>					
	<table border="1"> <thead> <tr> <th>Weigh Date</th> <th>Weight</th> </tr> </thead> <tbody> <tr> <td>5/04/2016</td> <td>71 kg</td> </tr> <tr> <td>28/11/2016</td> <td>89 kg</td> </tr> </tbody> </table>	Weigh Date	Weight	5/04/2016	71 kg	28/11/2016
Weigh Date	Weight					
5/04/2016	71 kg					
28/11/2016	89 kg					

Pedigree:

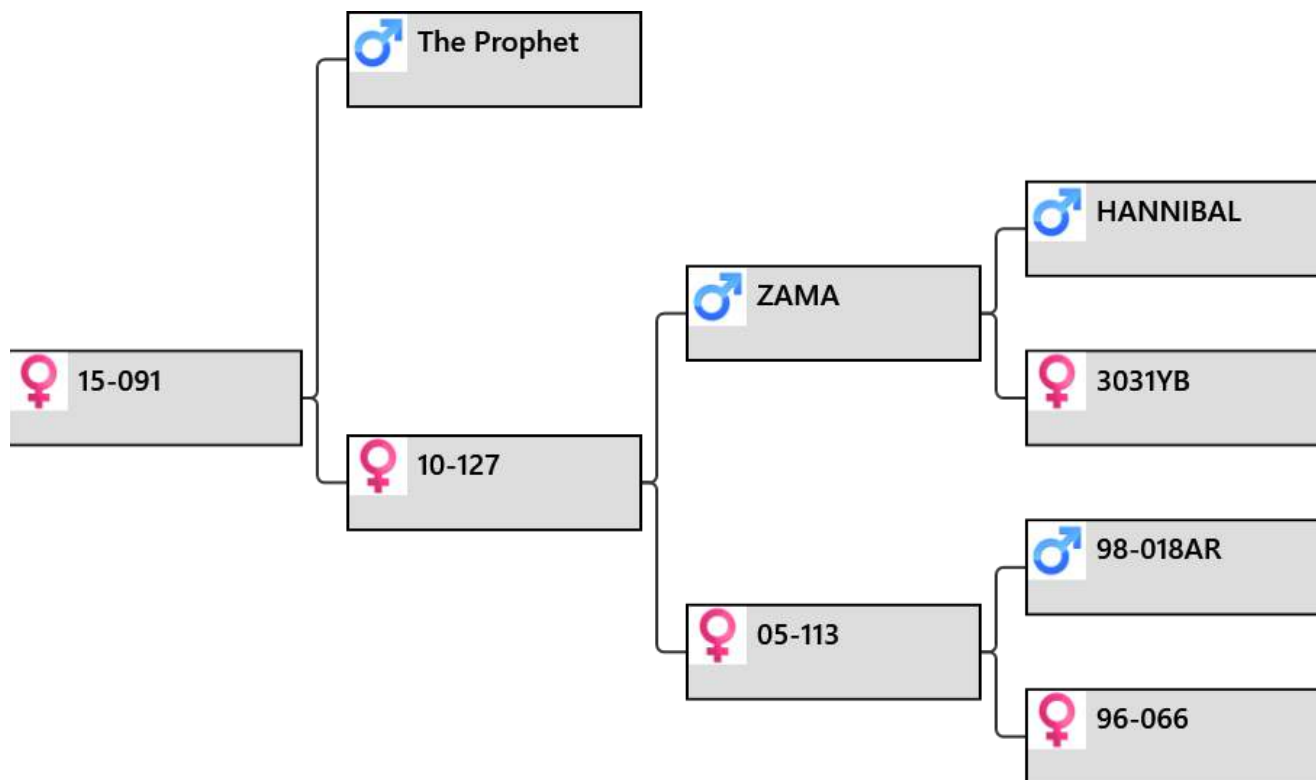

Biography:

We are only able to offer so many of these good "The Prophet " daughters because the year we leased him we programed his hinds and have a lot to choose from.

127-10 4 daughters with one sold 2014 for \$2,000.

113-05 a son cutting 4.35kg @ 2yr.

66-96 a son used in the stud and one sold 2012 sale.

Sale weight:

Price:

Buyer:

lot # 65 – Yearling hind



Altrive Red Deer
performance recorded since 1985
Yearling Hind sale 2017

Animal: **15-095**

Birthdate: 2015

Weigh Date	Weight
5/04/2016	66 kg
28/11/2016	107 kg

Pedigree:

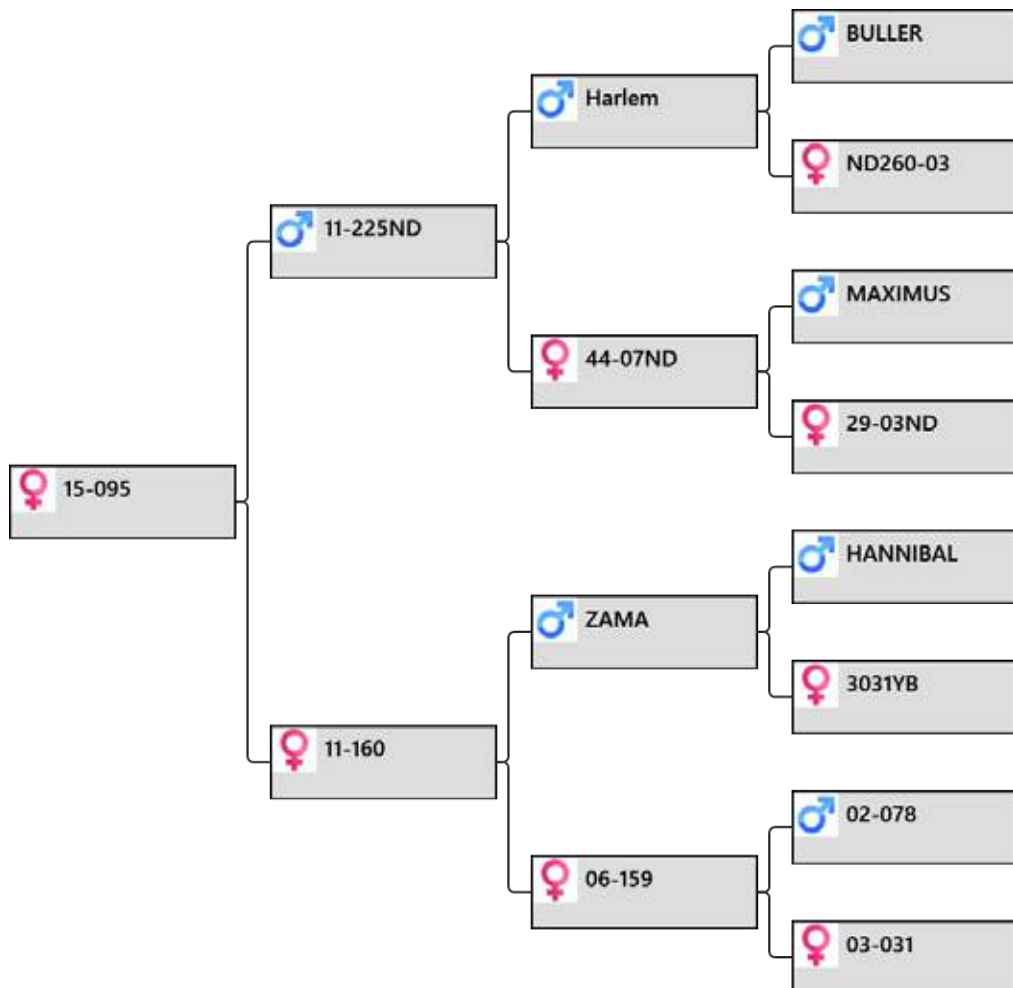

Biography:

95-15 by 225-11 12kg SA
 160-11 by Zama 12.25kg SA. 160-11 three daughters.
 159-06 four daughters
 31-03 a son cutting 8kg @ 4yr.

Sale weight:

Price:

Buyer:



lot # 66 – Yearling hind

 <p>performance recorded since 1985</p> <p>Yearling Hind sale 2017</p>	<p>Animal: 15-109</p> <hr/> <p>Birthdate: 2015</p> <table border="1"> <thead> <tr> <th>Weigh Date</th> <th>Weight</th> </tr> </thead> <tbody> <tr> <td>5/04/2016</td> <td>59 kg</td> </tr> <tr> <td>28/11/2016</td> <td>76 kg</td> </tr> </tbody> </table>	Weigh Date	Weight	5/04/2016	59 kg	28/11/2016	76 kg
	Weigh Date	Weight					
5/04/2016	59 kg						
28/11/2016	76 kg						

Pedigree:

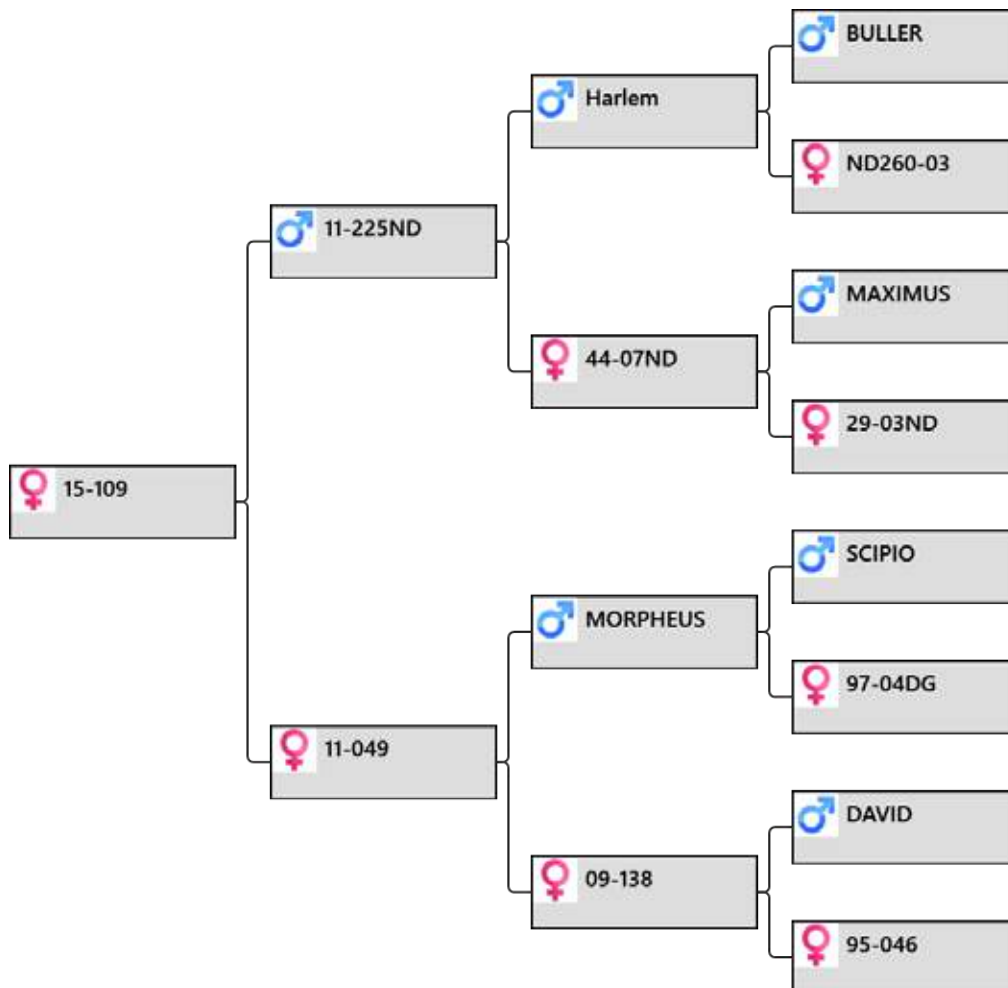

Biography:

109-15 by 225-11 12kg SA 5yr
 49-11 by Morpheus out of full sister to sire 186-04 used in stud.186-04 velvet & trophy.
 46-95 dam of 2 sires used in stud. Both sold as trophies
 Dam of 46-95 is 67-92 dam of a sire used in stud and sold as trophy

Sale weight: Price: Buyer:

lot # 67 – Yearling hind

 <p>Altrive Red Deer</p> <p>performance recorded since 1985</p> <p>Yearling Hind sale 2017</p>	<p>Animal: 15-110</p> <hr/> <p>Birthdate: 2015</p>						
	<table border="1"> <thead> <tr> <th>Weigh Date</th> <th>Weight</th> </tr> </thead> <tbody> <tr> <td>5/04/2016</td> <td>59 kg</td> </tr> <tr> <td>28/11/2016</td> <td>87 kg</td> </tr> </tbody> </table>	Weigh Date	Weight	5/04/2016	59 kg	28/11/2016	87 kg
	Weigh Date	Weight					
5/04/2016	59 kg						
28/11/2016	87 kg						

Pedigree:

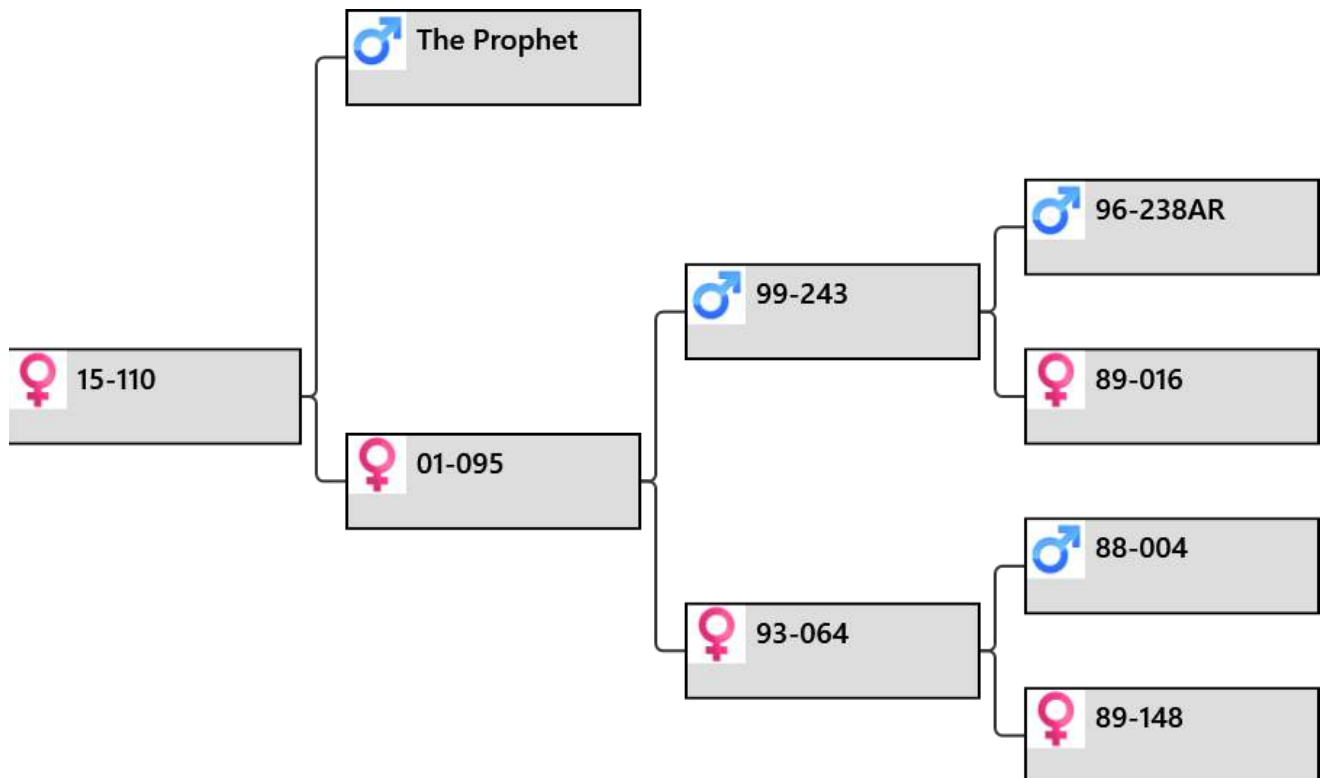

Biography:

110-15 by The Prophet 10.6kg
 95-01 son sold 2015 \$4,500 dam of 2yr olds cutting 4.8, 4.0, 3.75, 3.75, 3.8kg
 64-93 a son sold as trophy. A son cutting 3.8kg @ 2yr.

Sale weight: _____ Price: _____ Buyer: _____



lot # 68 – Yearling hind

 performance recorded since 1985 Yearling Hind sale 2017	Animal: 15-111					
	Birthdate: 2015 <table border="1"> <thead> <tr> <th>Weigh Date</th> <th>Weight</th> </tr> </thead> <tbody> <tr> <td>5/04/2016</td> <td>55 kg</td> </tr> <tr> <td>28/11/2016</td> <td>79 kg</td> </tr> </tbody> </table>	Weigh Date	Weight	5/04/2016	55 kg	28/11/2016
Weigh Date	Weight					
5/04/2016	55 kg					
28/11/2016	79 kg					

Pedigree:

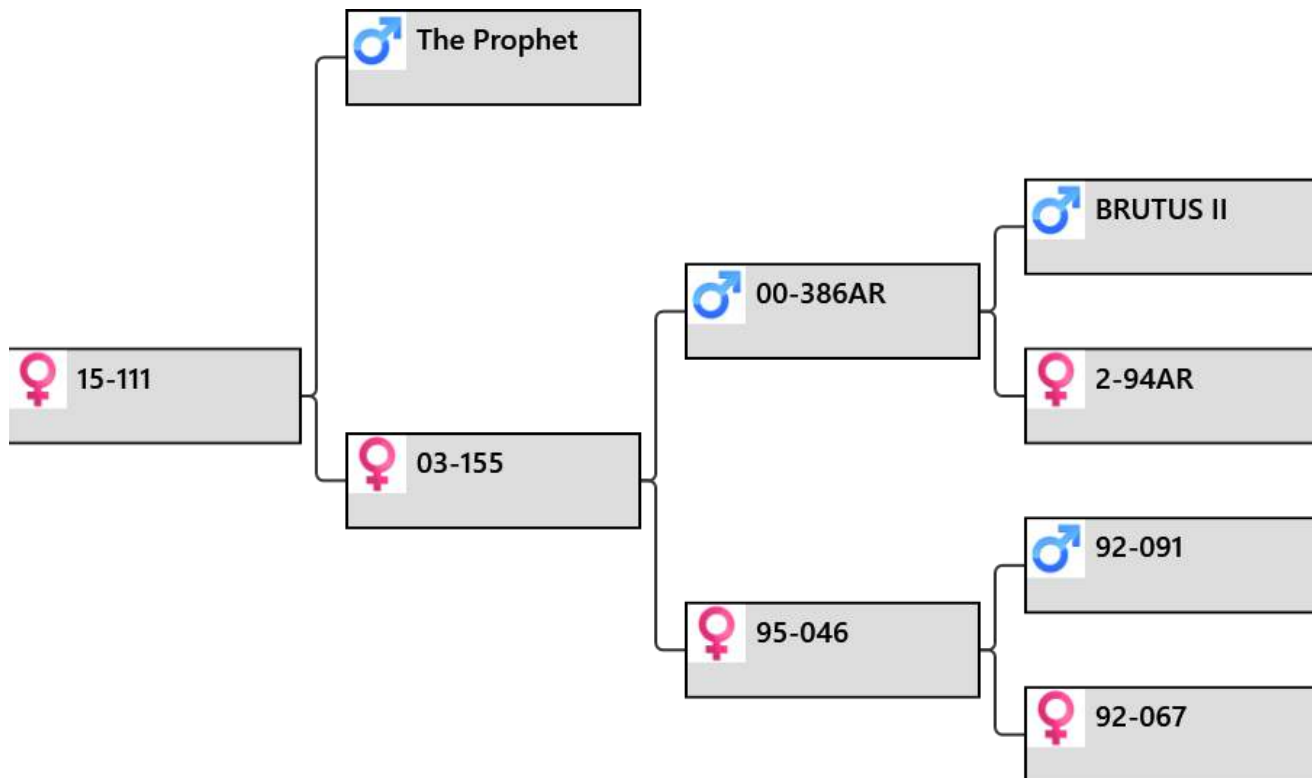

Biography:

155-03 by 386-00 (Swazi) 15.5kg SS. 155-03 dam of 5 sets of tws. Sons sold 2013 and 2014. She had sons cutting 4.55, 4.25, and 3.55 @ 2yr
 46-95 dam of 2 sons used in stud. 67-92 dam of sire used in stud. This is a top dam line with 46-95 being dam of 152-01 mother of Victrix \$10,500 sold to Arawata.
 102-06 sold \$10,500 198-12 sold \$7,000 and a daughter sold for \$4,000.

Sale weight: _____ Price: _____ Buyer: _____

lot # 69 – Yearling hind

**Altrive
Red Deer**

performance recorded since 1985

Yearling Hind sale 2017

Animal: **15-128**

Birthdate: 2015

Weigh Date **Weight**

5/04/2016 67 kg

28/11/2016 92 kg

Pedigree:

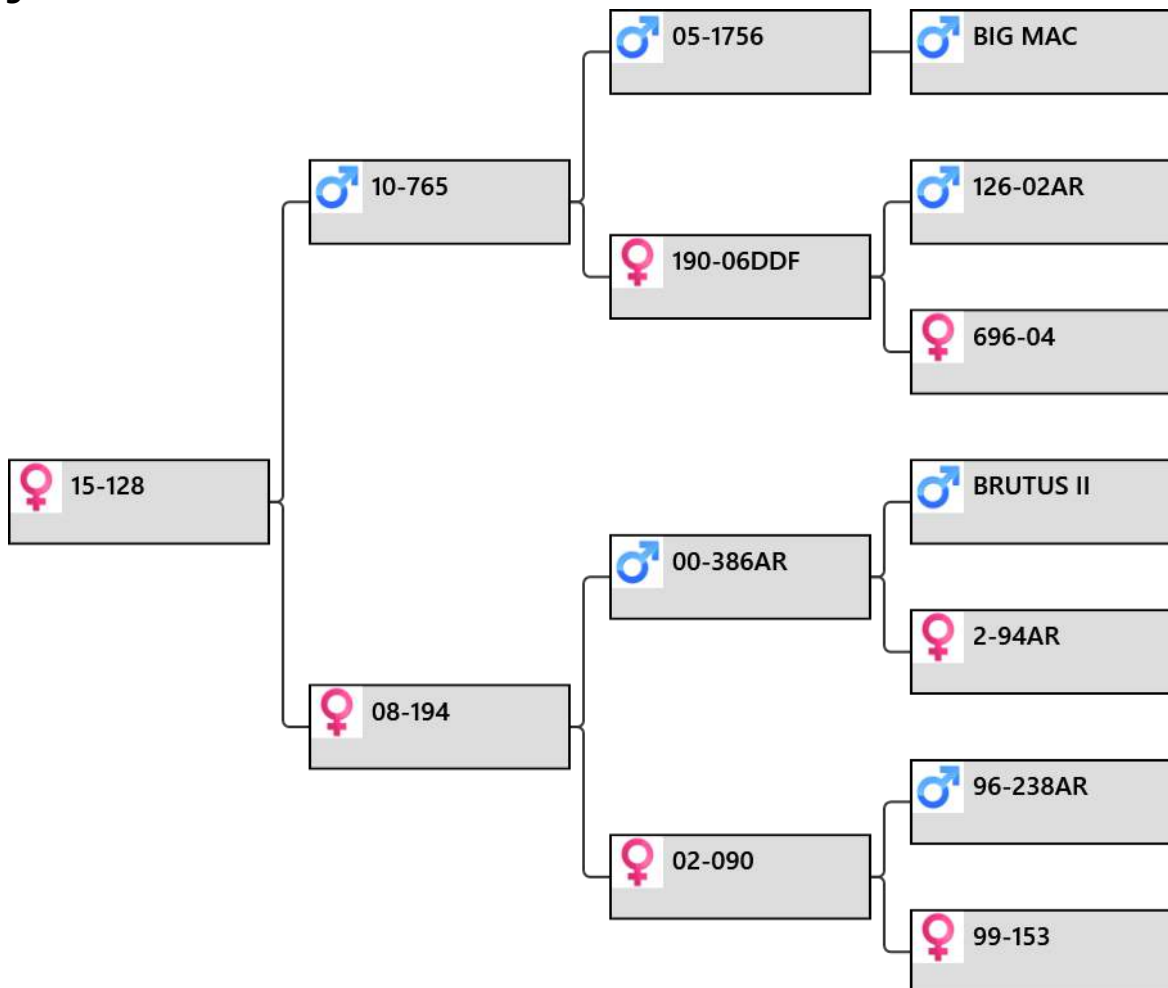

Biography:

128-15 by 765-10 (Has some of his first crop of sons in this catalogue)

194-08 sons cutting 4.55, 4.2 and 3.75kg @ 2yr

90-02 a son cutting 4.0kg @ 2yr

Sale weight:

Price:

Buyer:



lot # 70 – Yearling hind

 <p>Altrive Red Deer performance recorded since 1985 Yearling Hind sale 2017</p>	<p>Animal: 15-129</p> <hr/> <p>Birthdate: 2015</p> <table border="1"> <thead> <tr> <th>Weigh Date</th> <th>Weight</th> </tr> </thead> <tbody> <tr> <td>5/04/2016</td> <td>52 kg</td> </tr> <tr> <td>28/11/2016</td> <td>83 kg</td> </tr> </tbody> </table>	Weigh Date	Weight	5/04/2016	52 kg	28/11/2016	83 kg
	Weigh Date	Weight					
5/04/2016	52 kg						
28/11/2016	83 kg						

Pedigree:

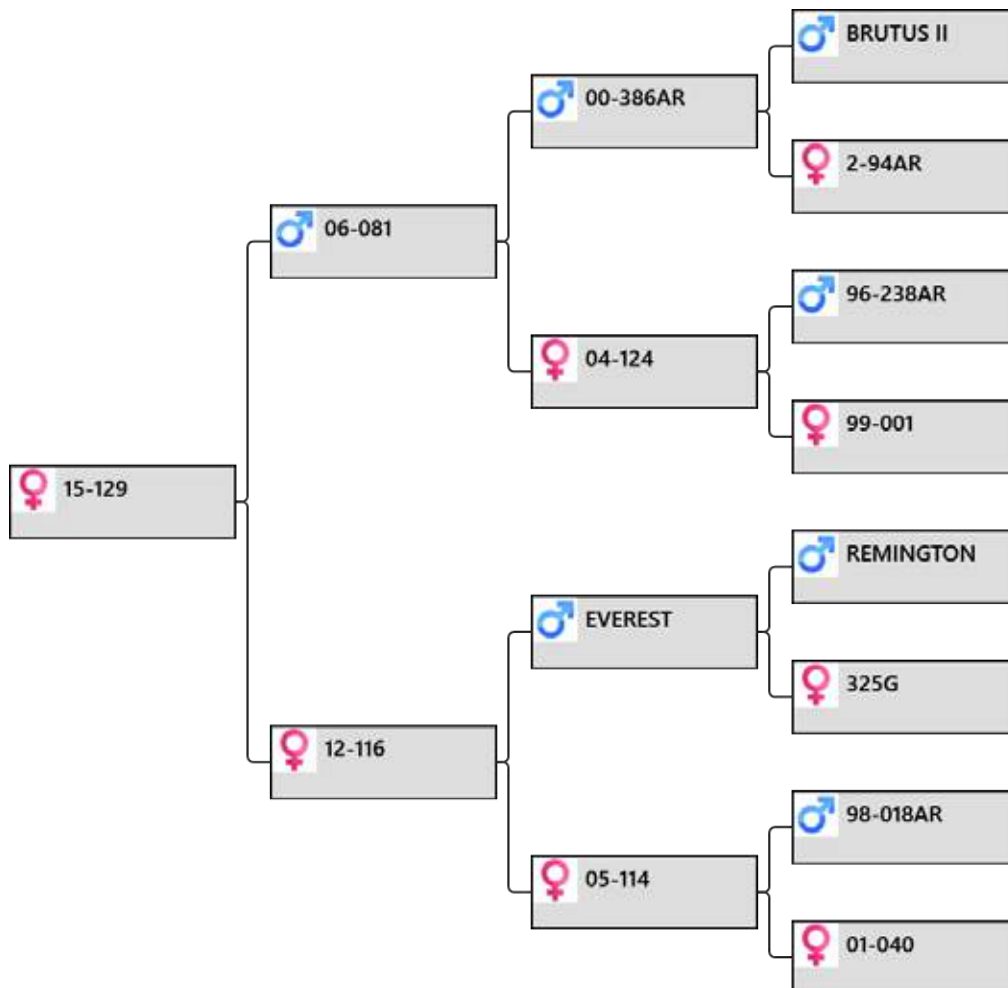

Biography:

129-15 by 81-06 18.4kg SS with sons cutting to 8.6kg @ 3yr.
 116-12 by Everest, maybe the top velvet sire in the industry. 116-12 no sons velveted yet.
 114-05 sons cutting 4.3 and 3.95kg @ 2yr
 40-01 sons cutting 5.05 and 4.15 kg @ 2yr

Sale weight: Price: Buyer:

lot # 71 – Yearling hind

**Altrive
Red Deer**



performance recorded since 1985

Yearling Hind sale 2017

Animal: **15-130**

Birthdate: 2015

Weigh Date **Weight**

28/11/2016 91 kg

Pedigree:

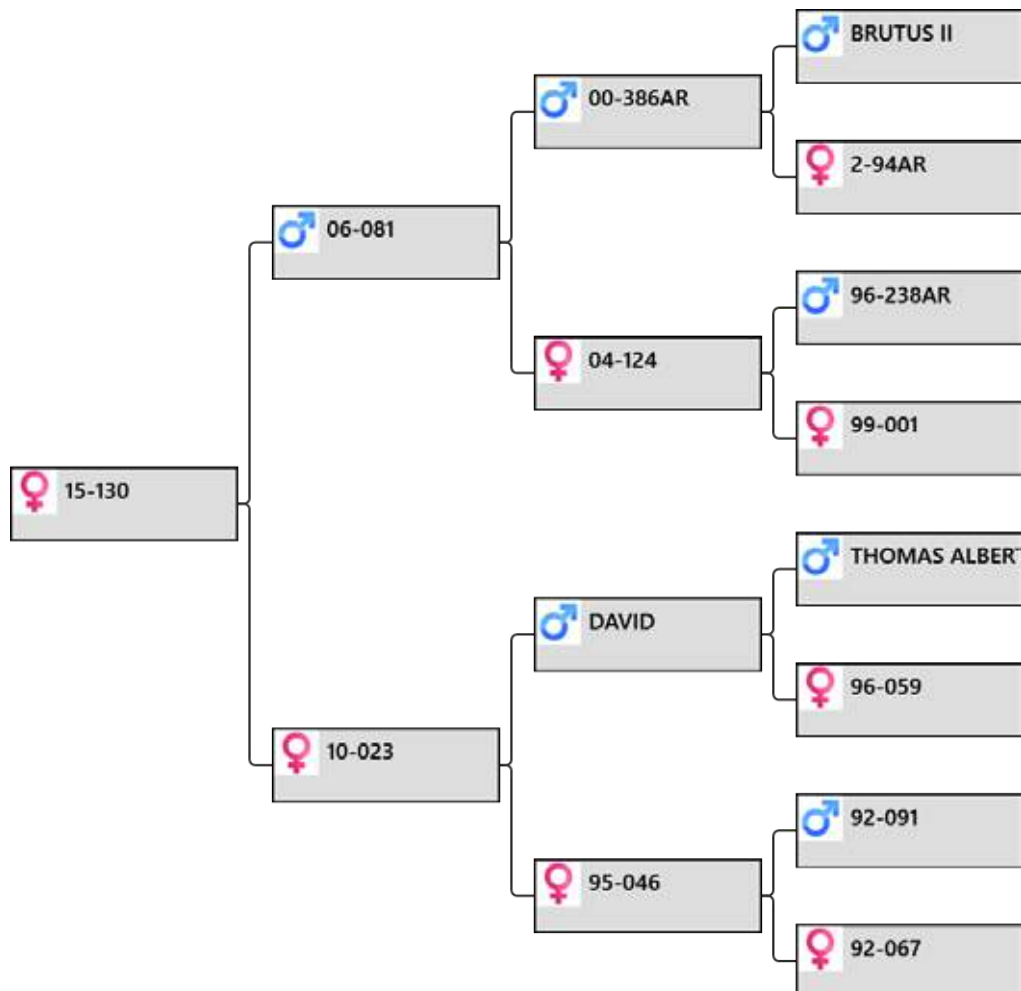

Biography:

130-15 again by 81-06 who has 25cm beam and 30 and 33cm pedicles.

23-10 by David 11kg. She has no sons velveted at catalogue time. 23-10 another full sister of 186-04 (trophy head on wall at sale venue)

46-95 dam of 2 sires used in stud and she had 7 other daughters with the best one being the dam of Victrix

Sale weight:

Price:

Buyer:



lot # 72 – Yearling hind

 <p>performance recorded since 1985</p> <p>Yearling Hind sale 2017</p>	<p>Animal: 15-133</p> <hr/> <p>Birthdate: 2015</p> <table border="1"> <thead> <tr> <th>Weigh Date</th> <th>Weight</th> </tr> </thead> <tbody> <tr> <td>5/04/2016</td> <td>53 kg</td> </tr> <tr> <td>28/11/2016</td> <td>82 kg</td> </tr> </tbody> </table>	Weigh Date	Weight	5/04/2016	53 kg	28/11/2016	82 kg
	Weigh Date	Weight					
5/04/2016	53 kg						
28/11/2016	82 kg						

Pedigree:

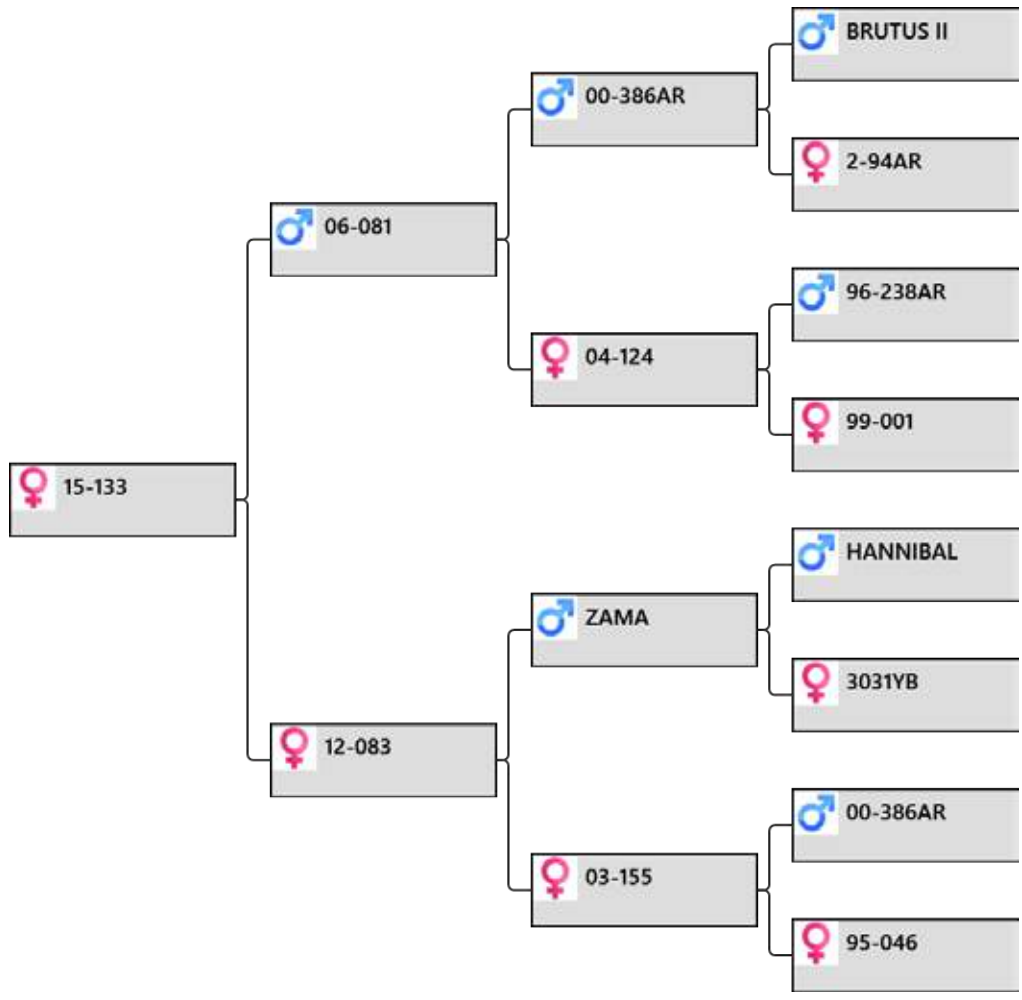

Biography:

133-15 by 81-06 4yr National Champion.
 83-12 no sons velveted yet. 83-12 by Zama 12.2kg SA sire of our 10.6 kg 3yr old.
 155-03, (once again that very good dam line going back to 46-95)

Sale weight: Price: Buyer:

lot # 73 – Yearling hind



**Altrive
Red Deer**
performance recorded since 1985
Yearling Hind sale 2017

Animal: **15-141**

Birthdate: 2015

Weigh Date	Weight
5/04/2016	60 kg
28/11/2016	80 kg

Pedigree:

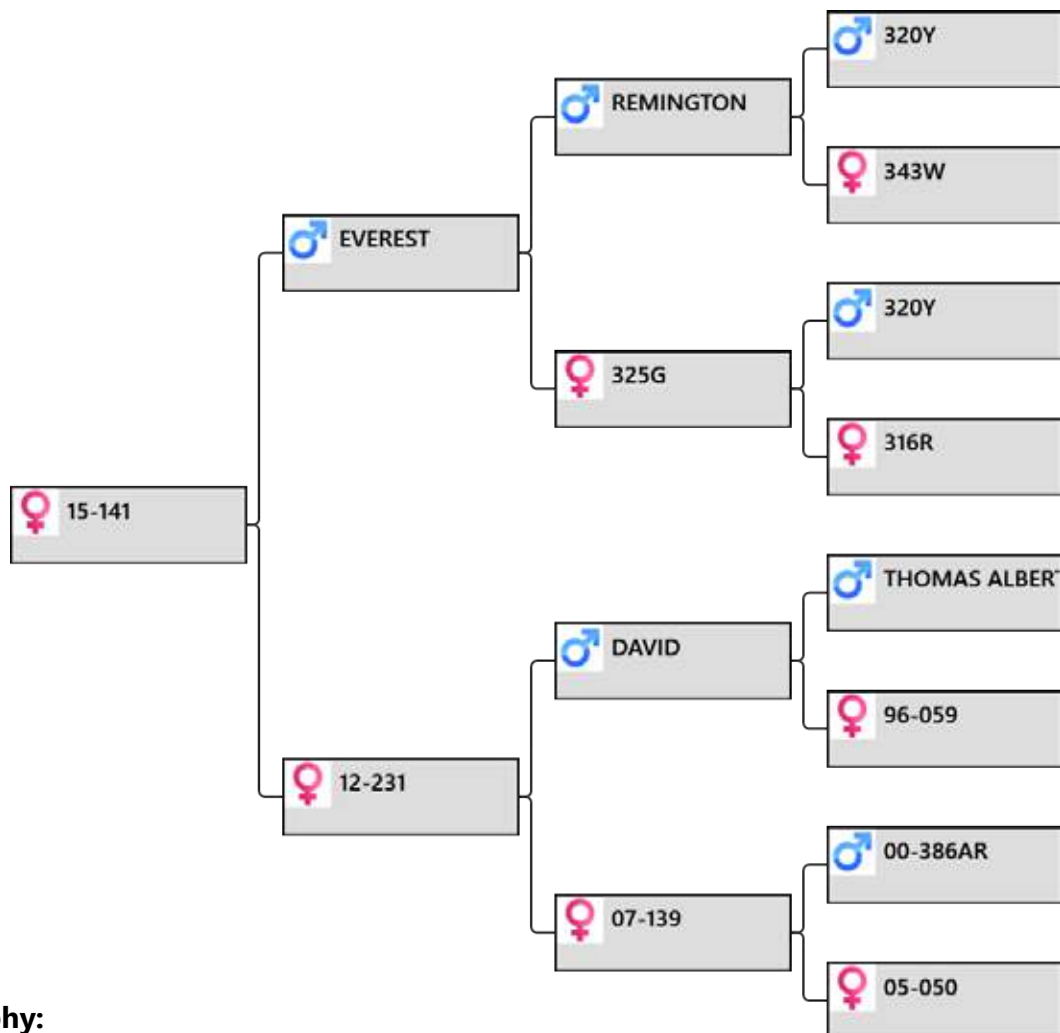

Biography:

141-15 by Everest 12.25 kg SA. Everest now 12 yr old and we are not parting with many of his daughters.

231-12 by David 11kg SA. 231-12 three daughters no sons yet.

139-07 sons cutting 4.25 and 3.75kg @ 2yr

139-07 by 386-00 (Swazi) sire of 81-06 18.4kg SS. 139-07 a son cutting 4.25 @ 2yr

Sale weight:

Price:

Buyer:



lot # 74 – Yearling hind

 <p>Altrive Red Deer performance recorded since 1985 Yearling Hind sale 2017</p>	<p>Animal: 15-148</p> <hr/> <p>Birthdate: 2015</p> <table border="1"> <thead> <tr> <th>Weigh Date</th> <th>Weight</th> </tr> </thead> <tbody> <tr> <td>5/04/2016</td> <td>61 kg</td> </tr> <tr> <td>28/11/2016</td> <td>86 kg</td> </tr> </tbody> </table>	Weigh Date	Weight	5/04/2016	61 kg	28/11/2016	86 kg
	Weigh Date	Weight					
5/04/2016	61 kg						
28/11/2016	86 kg						

Pedigree:

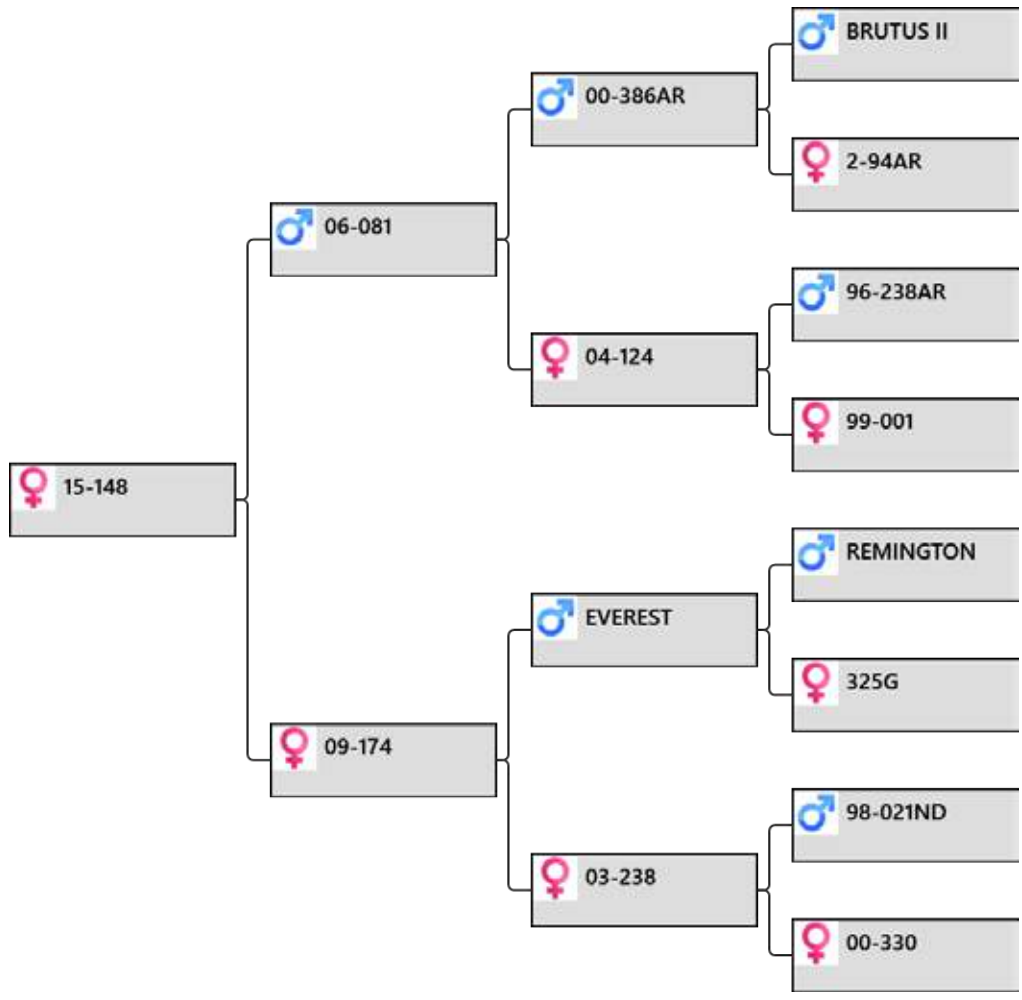

Biography:

148-15 by 81-06 out of an Everest daughter
 174-09 who has one son velveted so far and he cut 3.8kg @ 2yr
 238-03 has sons cutting 3.85 and 3.75kg @ 2yr with one sold as sire 2012

Sale weight: Price: Buyer:

lot # 75 – Yearling hind

**Altrive
Red Deer**



performance recorded since 1985

Yearling Hind sale 2017

Animal: **15-152**

Birthdate: 2015

Weigh Date **Weight**

5/04/2016 62 kg

28/11/2016 91 kg

Pedigree:

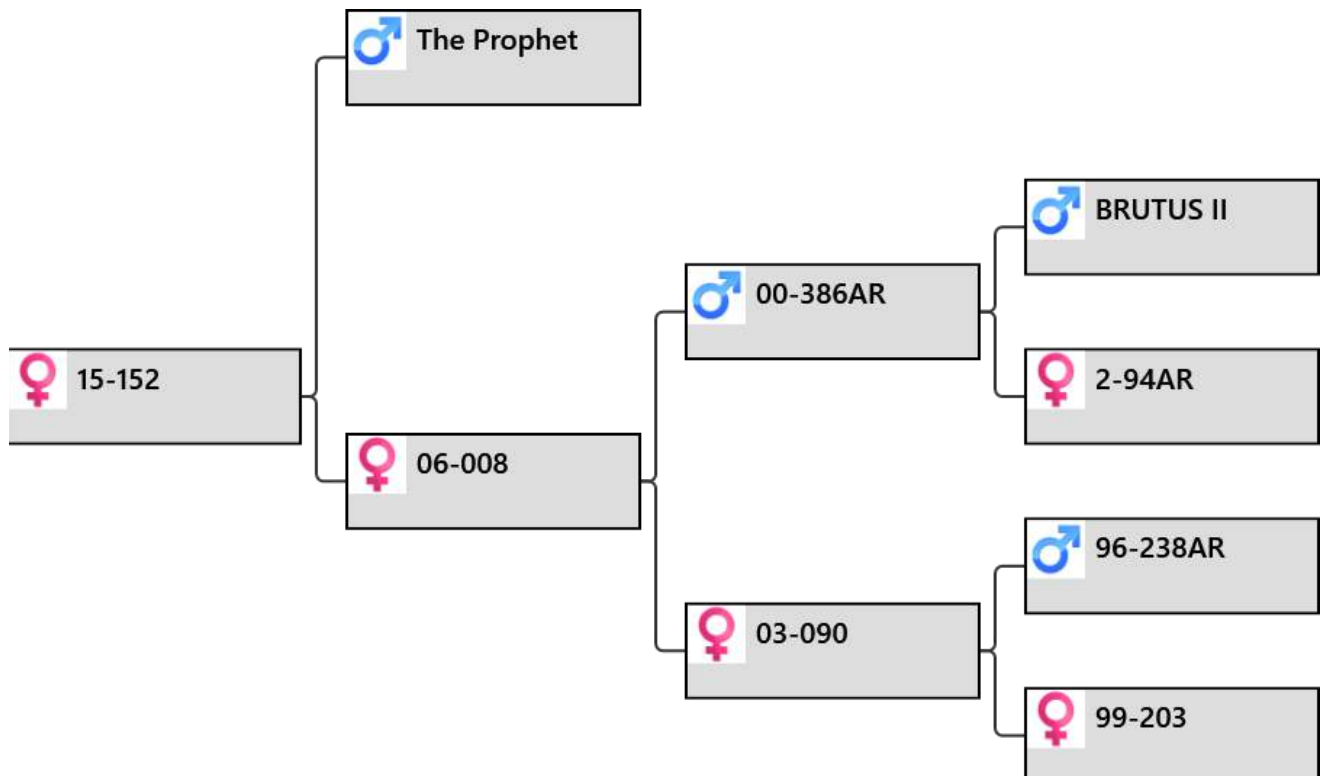

Biography:

152-15 daughter of The Prophet 10.6kg SA

8-06 a son sold 2012 sale and sons cutting 4.85, 4.5, 4.0 and 3.9kg @ 2yr

90-03 by 238-96 a top sire in his day by Charles Rupert.

238-96 and 386-00(Swazi) feature in a lot of top pedigrees

Sale weight:

Price:

Buyer:



lot # 76 – Yearling hind

 <p>Altrive Red Deer performance recorded since 1985 Yearling Hind sale 2017</p>	<p>Animal: 15-153</p> <hr/> <p>Birthdate: 2015</p> <table border="1"> <thead> <tr> <th>Weigh Date</th> <th>Weight</th> </tr> </thead> <tbody> <tr> <td>5/04/2016</td> <td>54 kg</td> </tr> <tr> <td>28/11/2016</td> <td>90 kg</td> </tr> </tbody> </table>	Weigh Date	Weight	5/04/2016	54 kg	28/11/2016	90 kg
	Weigh Date	Weight					
5/04/2016	54 kg						
28/11/2016	90 kg						

Pedigree:

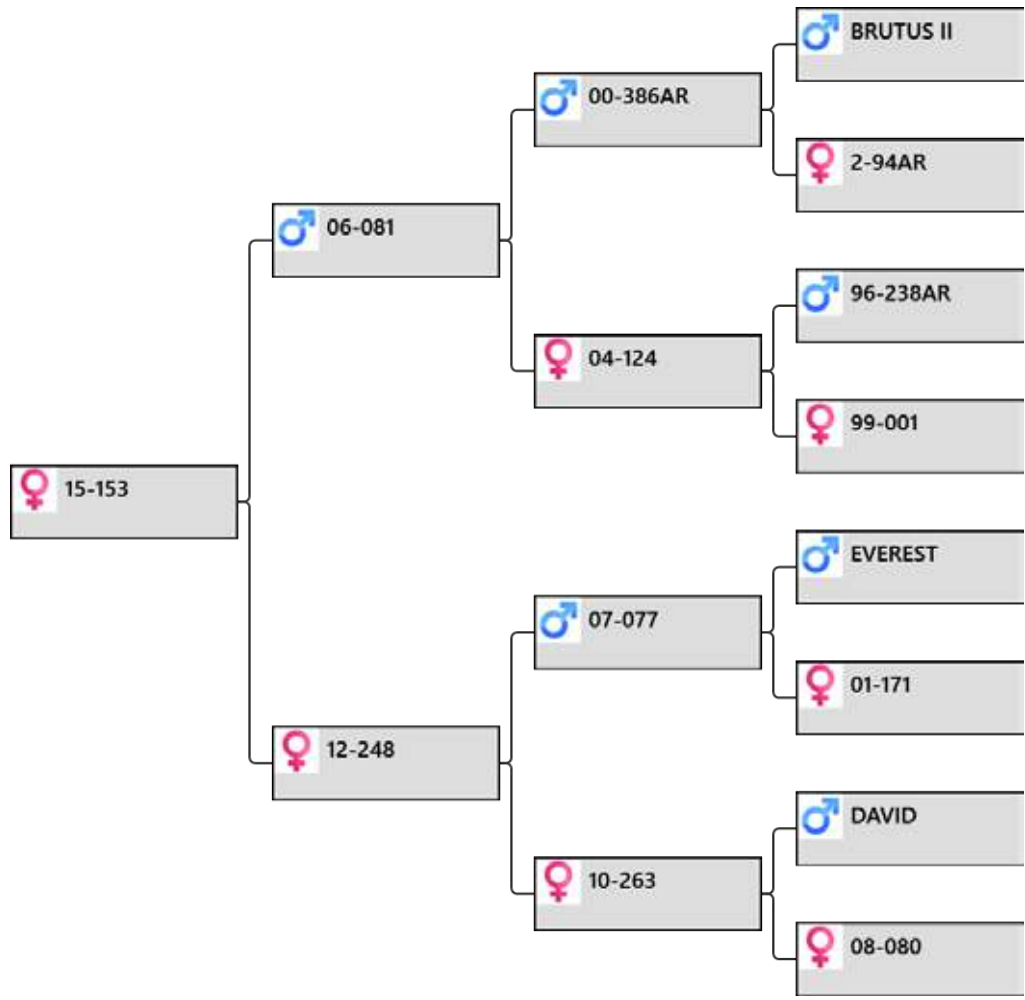

Biography:

153-14 by 81-06 18.4 kg SS
 248-12 by 77-07 10kg SA @ 6yr. 248-12 a daughter sold 2016 for \$2,800.
 263-10 a son cutting 4.5kg @ 2yr.
 80-08 a top hind used as a donor and dam of lot one 2015 \$25,000
 80-08 is another daughter of that top hind 122-98

Sale weight: Price: Buyer:

lot # 77 – Yearling hind



Animal: **15-160**

Birthdate: 2015

Weigh Date	Weight
5/04/2016	58 kg
28/11/2016	85 kg

Pedigree:

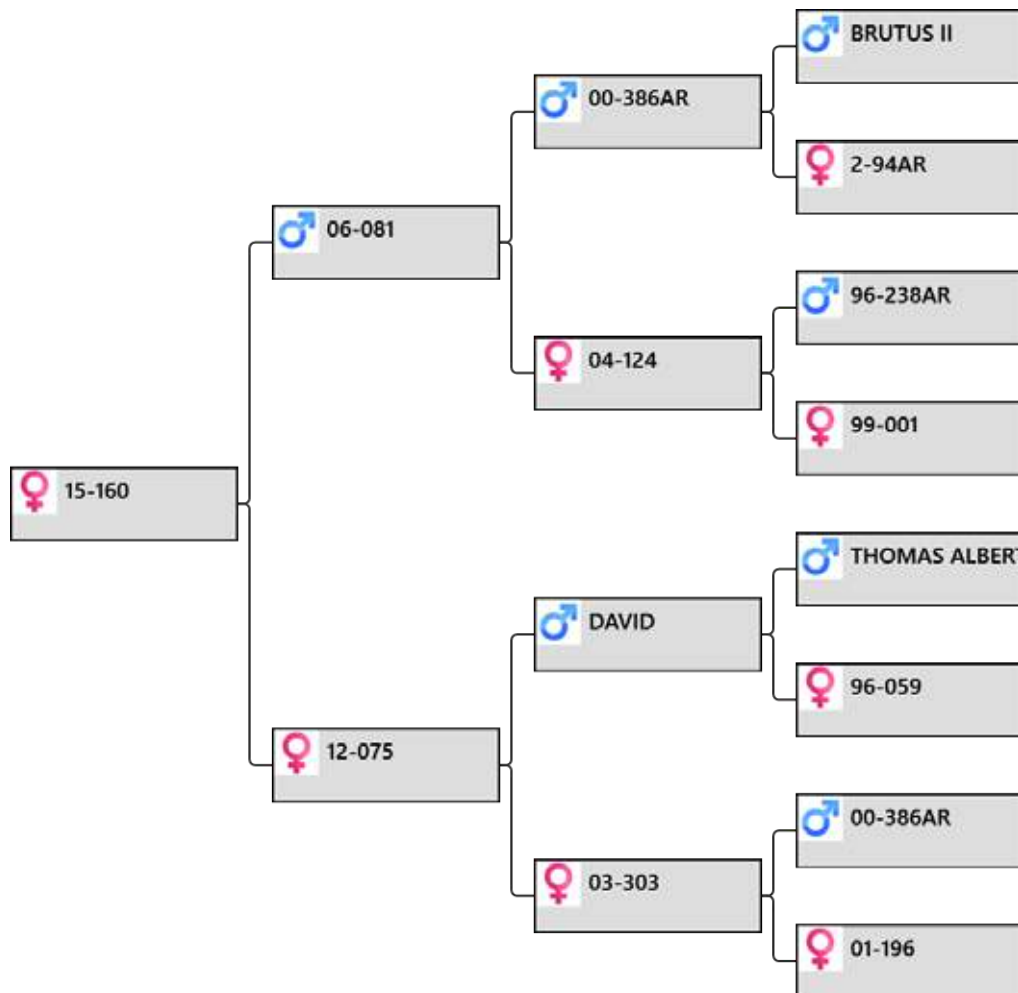

Biography:

160-15 by 81-06 4yr National Champion an runner up @ 5yr.
 75-12 no sons yet
 303-03 has a son cutting 5.75 @ 2yr that is a full brother to 75-12.
 196-01 out of 67-92 a top hind who features in our top dam line behind Victrix etc.

Sale weight:

Price:

Buyer:



lot # 78 – Yearling hind

 <p>performance recorded since 1985</p> <p>Yearling Hind sale 2017</p>	<p>Animal: 15-164</p> <hr/> <p>Birthdate: 2015</p> <table border="1"> <thead> <tr> <th>Weigh Date</th> <th>Weight</th> </tr> </thead> <tbody> <tr> <td>5/04/2016</td> <td>58 kg</td> </tr> <tr> <td>28/11/2016</td> <td>82 kg</td> </tr> </tbody> </table>	Weigh Date	Weight	5/04/2016	58 kg	28/11/2016	82 kg
	Weigh Date	Weight					
5/04/2016	58 kg						
28/11/2016	82 kg						

Pedigree:

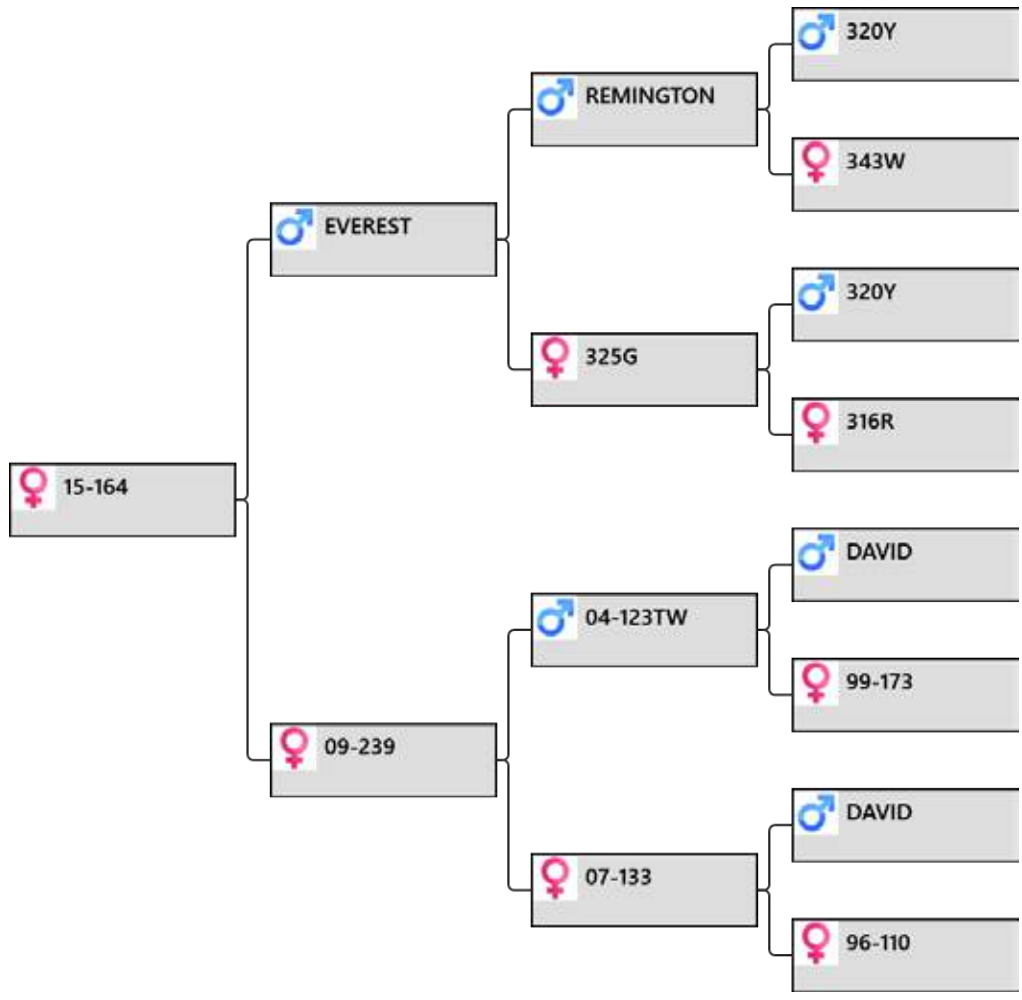

Biography:

164-15 by super sire Everest. He is now 12yr old so daughters for sale will be limited.
 239-09 by 123-04 502 IOA @ 4yr and he has left sons up to 7kg @ 3yr.
 239-09 has a son cutting 3.8kg @ 2yr.
 133-07 by David 11kg and she had 3 daughters only.

Sale weight: Price: Buyer:

lot # 79 – Yearling hind

**Altrive
Red Deer**

performance recorded since 1985

Yearling Hind sale 2017

Animal: **15-182**

Birthdate: 2015

Weigh Date **Weight**

5/04/2016 54 kg

28/11/2016 85 kg

Pedigree:

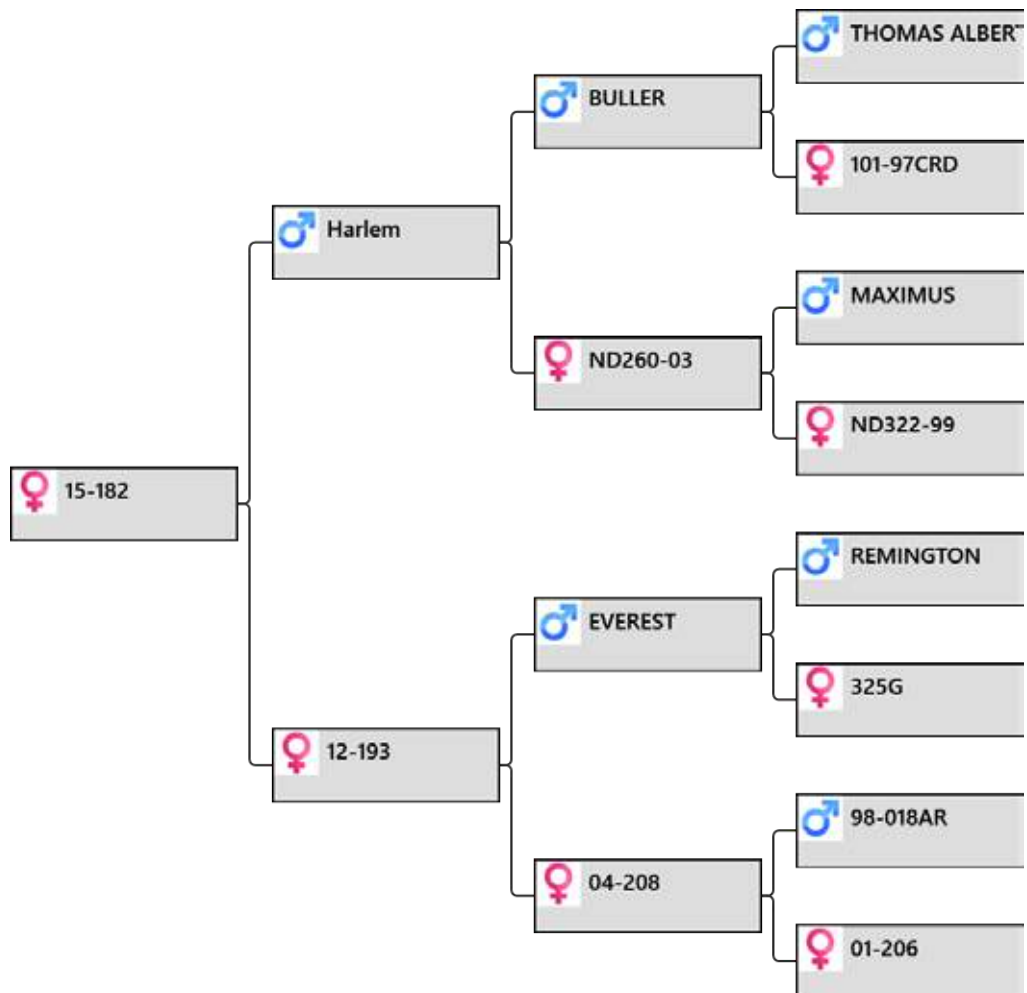

Biography:

182-15 is out of our embryo program. She is up for sale but we will not part with her easily.

182-15 by Harlem from Netherdale Stud is a Buller son and is a top breeder.

193-12 we consider has one of the best proven pedigrees we can offer. Her 4 brothers in last years sale made \$27,000, \$7,000, \$4,000 and \$5,000

208-04 dam of sons above plus sons sold for \$10,500, \$5,000 and \$2,500

Sale weight:

Price:

Buyer:



lot # 80 – Yearling hind

 <p>performance recorded since 1985</p> <p>Yearling Hind sale 2017</p>	<p>Animal: 15-206</p> <hr/> <p>Birthdate: 2015</p> <table border="1"> <thead> <tr> <th>Weigh Date</th> <th>Weight</th> </tr> </thead> <tbody> <tr> <td>5/04/2016</td> <td>65 kg</td> </tr> <tr> <td>28/11/2016</td> <td>100 kg</td> </tr> </tbody> </table>	Weigh Date	Weight	5/04/2016	65 kg	28/11/2016	100 kg
	Weigh Date	Weight					
5/04/2016	65 kg						
28/11/2016	100 kg						

Pedigree:

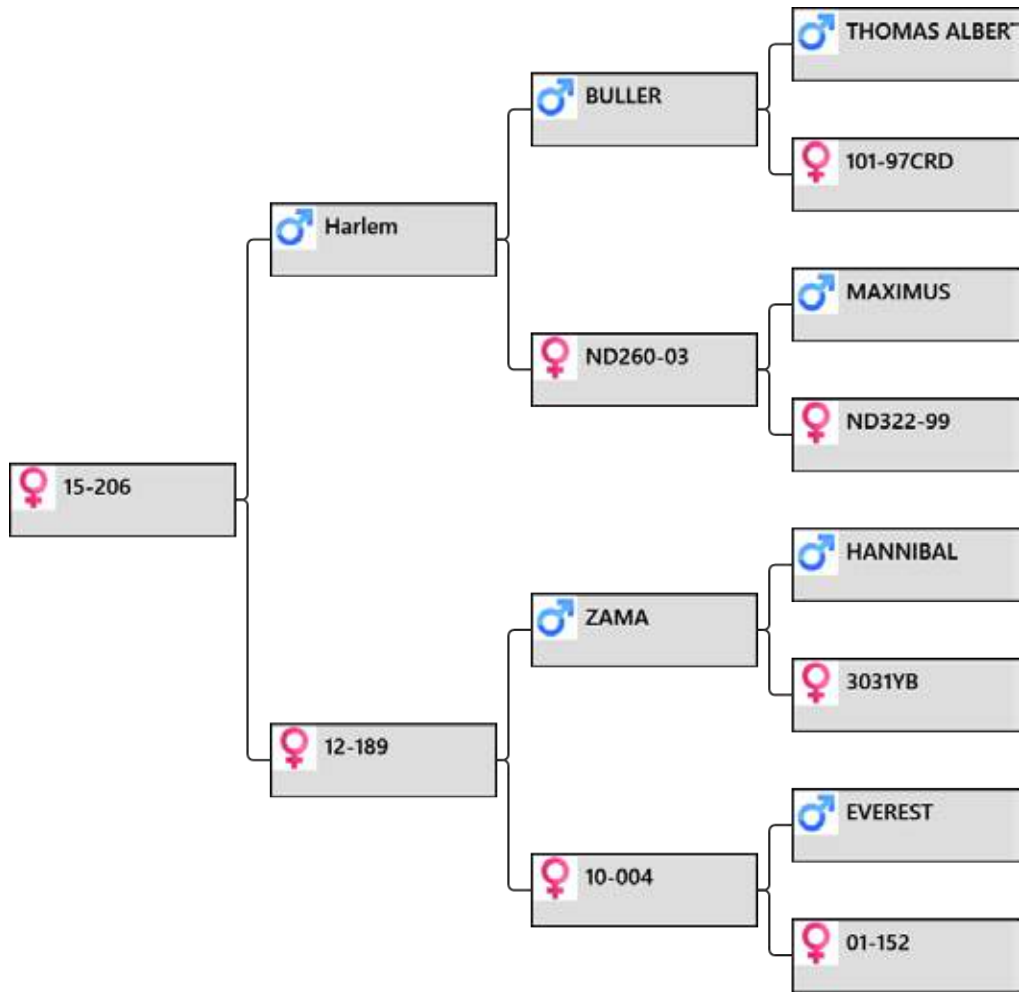

Biography:

206-15 also out of our embryo program and is by Harlem
 189-12 by Zama and she is embryo sister to lot 13 2016 \$17,000
 4-10 by Everest with a daughter sold for \$3,400 and a son \$17,000
 152-01 son sold to Alf Kinzett \$10,500 and she is dam of Victrix sold to Arawata Stud

Sale weight: Price: Buyer:

lot # 81 – Yearling hind



Animal: **15-207**

Birthdate: 2015

Weigh Date	Weight
5/04/2016	56 kg
28/11/2016	83 kg

Pedigree:

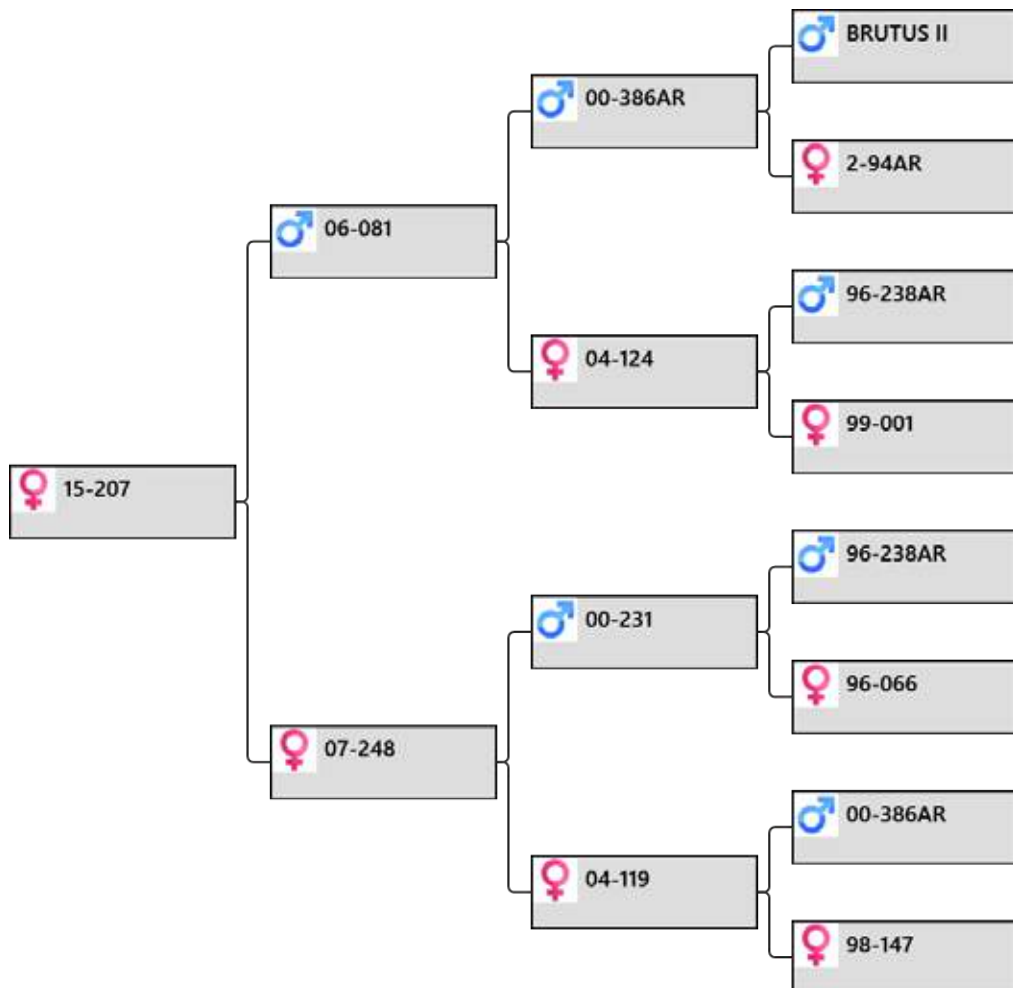

Biography:

207-15 out of embryo program by 81-06
 81-06 cut a massive SS head of 18.4kg this year and he was the sire of lot one
 2014 sold for \$20,000 and sire of lots 2, 3, and 5 this year.
 248-07 dam of lot 2 2015 \$14,500 and lot 10 \$6,500

Sale weight:

Price:

Buyer:



lot # 82 – Yearling hind

 <p>Altrive Red Deer performance recorded since 1985 Yearling Hind sale 2017</p>	<p>Animal: 15-220</p> <hr/> <p>Birthdate: 2015</p> <table border="1"> <thead> <tr> <th>Weigh Date</th> <th>Weight</th> </tr> </thead> <tbody> <tr> <td>5/04/2016</td> <td>60 kg</td> </tr> <tr> <td>28/11/2016</td> <td>78 kg</td> </tr> </tbody> </table>	Weigh Date	Weight	5/04/2016	60 kg	28/11/2016	78 kg
	Weigh Date	Weight					
5/04/2016	60 kg						
28/11/2016	78 kg						

Pedigree:

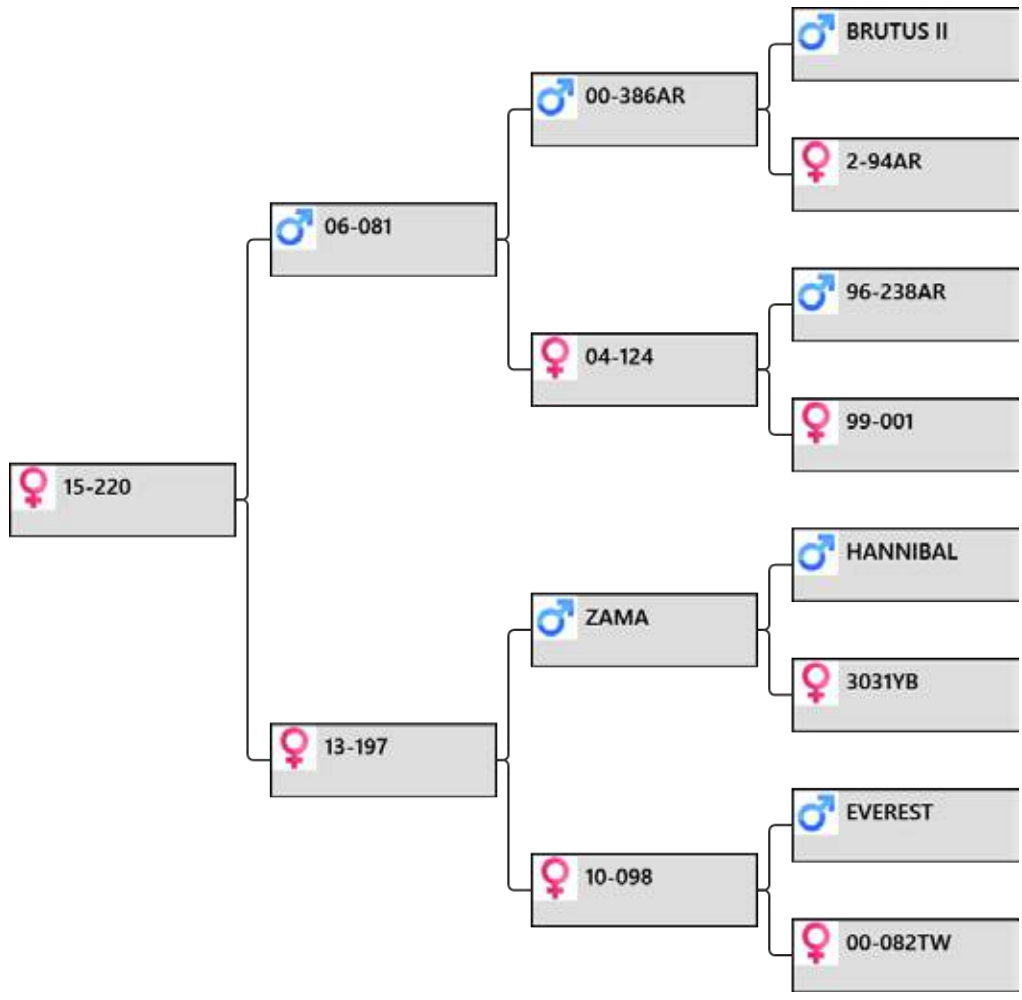

Biography:

220-15 by 81-06 4yr Champion
 197-13 a first fawner by Zama a National Champion
 98-10 a top Everest daughter with sons cutting 5.35 and 4.0kg @ 2yr
 82-00 sons sold for \$15,000 and \$4,000

Sale weight: Price: Buyer:

lot # 83 – Yearling hind



**Altrive
Red Deer**

performance recorded since 1985

Yearling Hind sale 2017

Animal: **15-225**

Birthdate: 2015

Weigh Date	Weight
5/04/2016	56 kg
28/11/2016	84 kg

Pedigree:

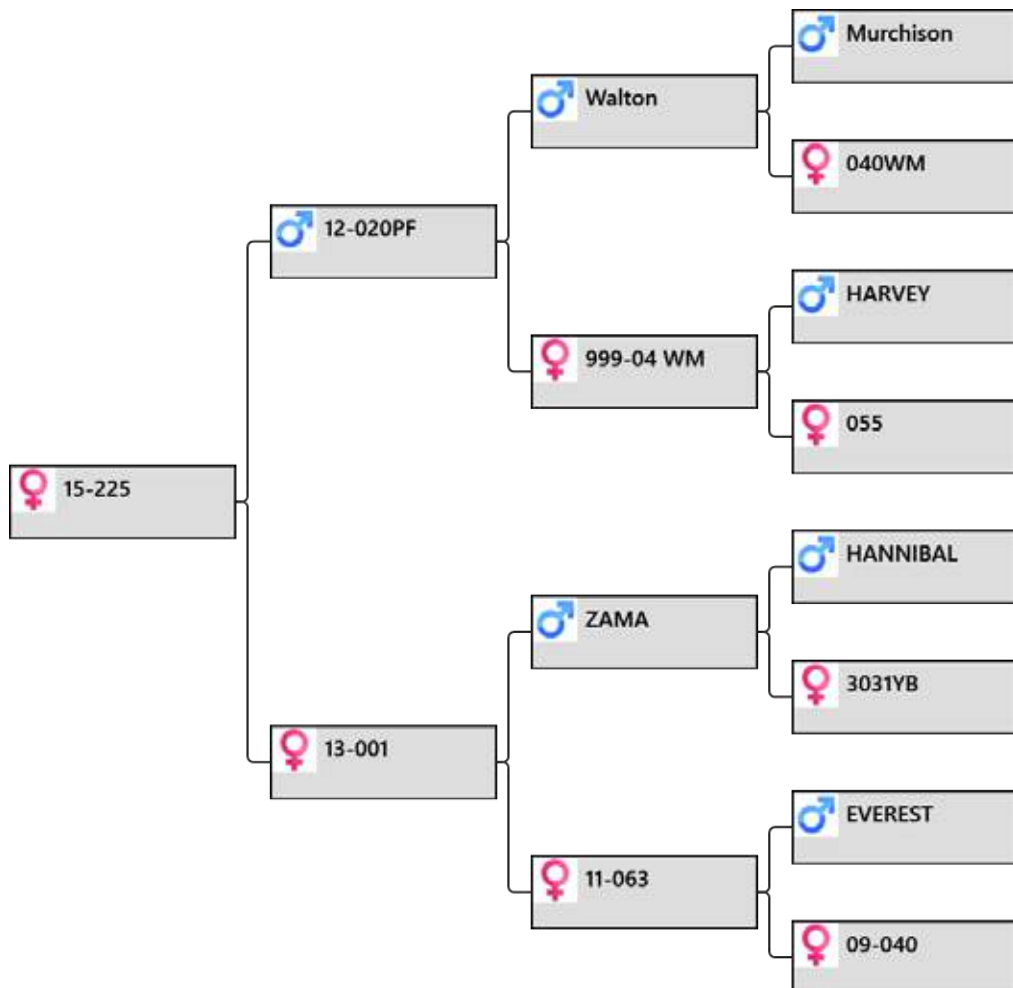

Biography:

225-15 by 20-12 from Peel Forest 8kg @ 4yr
 1-13 a first fawner
 63-11 by Everest with a son cutting 4.8kg @ 2yr
 40-09 a full sister to 81-06

Sale weight:

Price:

Buyer:



lot # 84 – Yearling hind

 <p>Altrive Red Deer performance recorded since 1985 Yearling Hind sale 2017</p>	<p>Animal: 15-229</p> <hr/> <p>Birthdate: 2015</p> <table border="1"> <thead> <tr> <th>Weigh Date</th> <th>Weight</th> </tr> </thead> <tbody> <tr> <td>5/04/2016</td> <td>55 kg</td> </tr> <tr> <td>28/11/2016</td> <td>83 kg</td> </tr> </tbody> </table>	Weigh Date	Weight	5/04/2016	55 kg	28/11/2016	83 kg
	Weigh Date	Weight					
5/04/2016	55 kg						
28/11/2016	83 kg						

Pedigree:

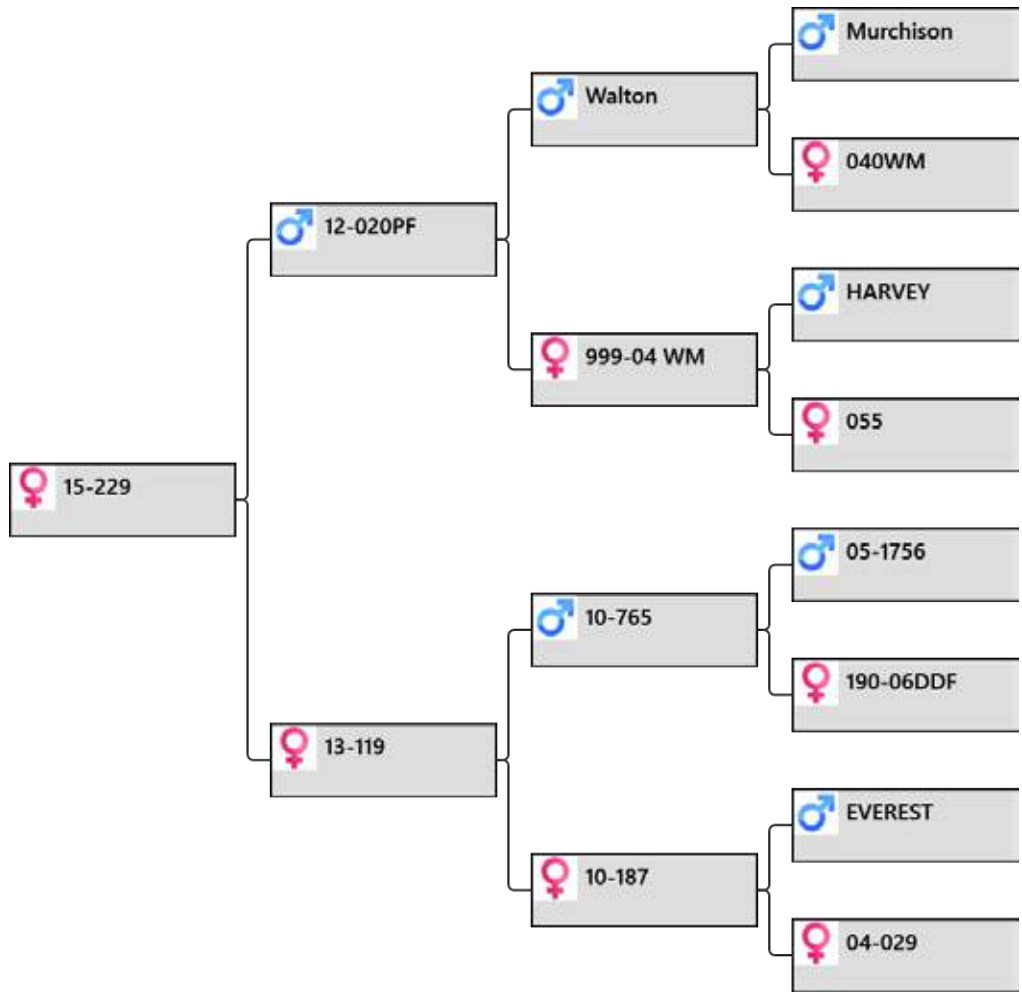

Biography:

229-15 by Peel Forest 20-12 a Walton son.
 119-13 a first fawner
 187-10 by Everest, only daughters so far.
 29-04 dam lot 13 2015 \$9,500 and lot 14 2016 \$7,500

Sale weight: Price: Buyer:

lot # 85 – Yearling hind



**Altrive
Red Deer**

performance recorded since 1985

Yearling Hind sale 2017

Animal: **15-233**

Birthdate: 2015

Weigh Date	Weight
5/04/2016	58 kg
28/11/2016	91 kg

Pedigree:

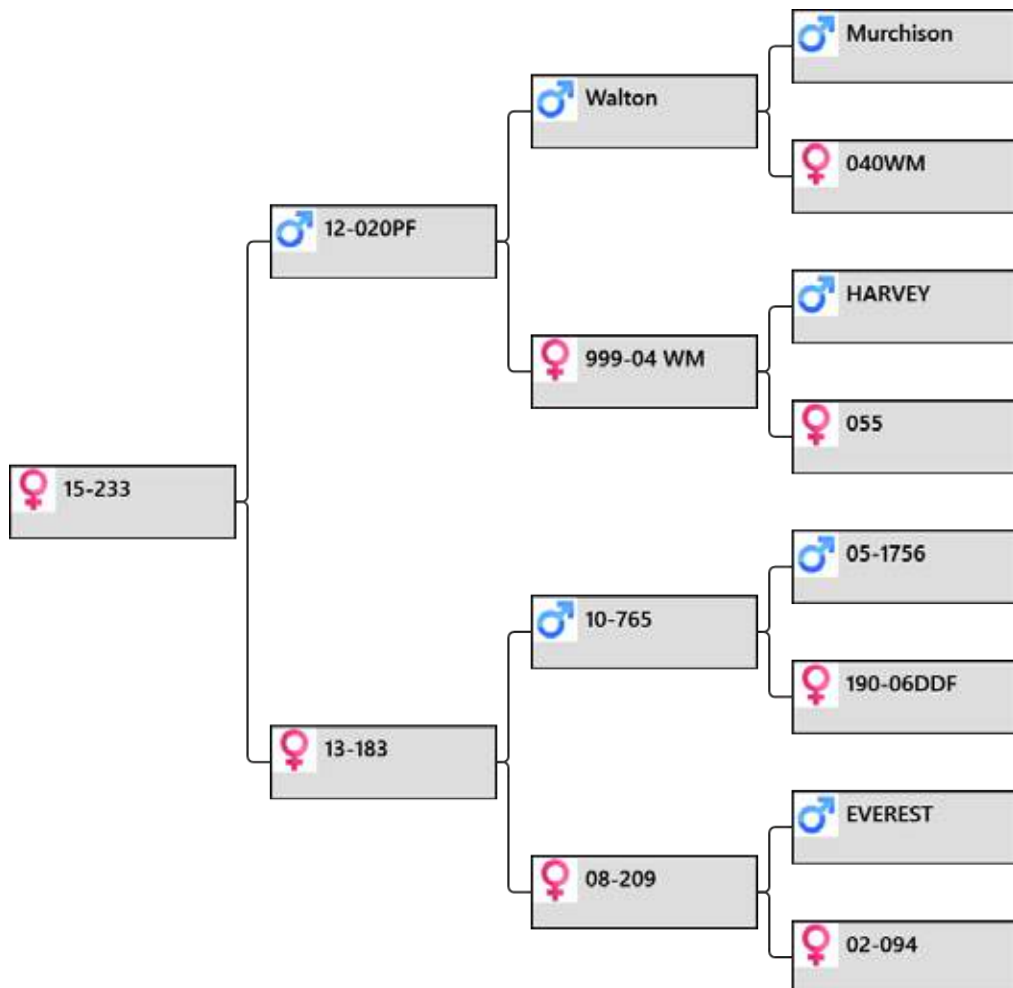

Biography:

233-15 by PF 20-12 8kg @ 4yr

183-13 a first fawner.

209-08 by Everest with a son sold for \$12,500 in 2014.

94-02 sons cutting 4.8 and 5.0kg @ 2yr.

Sale weight:

Price:

Buyer:



lot # 86 – Yearling hind

 <p>Altrive Red Deer performance recorded since 1985 Yearling Hind sale 2017</p>	<p>Animal: 15-236</p> <hr/> <p>Birthdate: 2015</p> <table border="1"> <thead> <tr> <th>Weigh Date</th> <th>Weight</th> </tr> </thead> <tbody> <tr> <td>5/04/2016</td> <td>50 kg</td> </tr> <tr> <td>28/11/2016</td> <td>76 kg</td> </tr> </tbody> </table>	Weigh Date	Weight	5/04/2016	50 kg	28/11/2016	76 kg
	Weigh Date	Weight					
5/04/2016	50 kg						
28/11/2016	76 kg						

Pedigree:

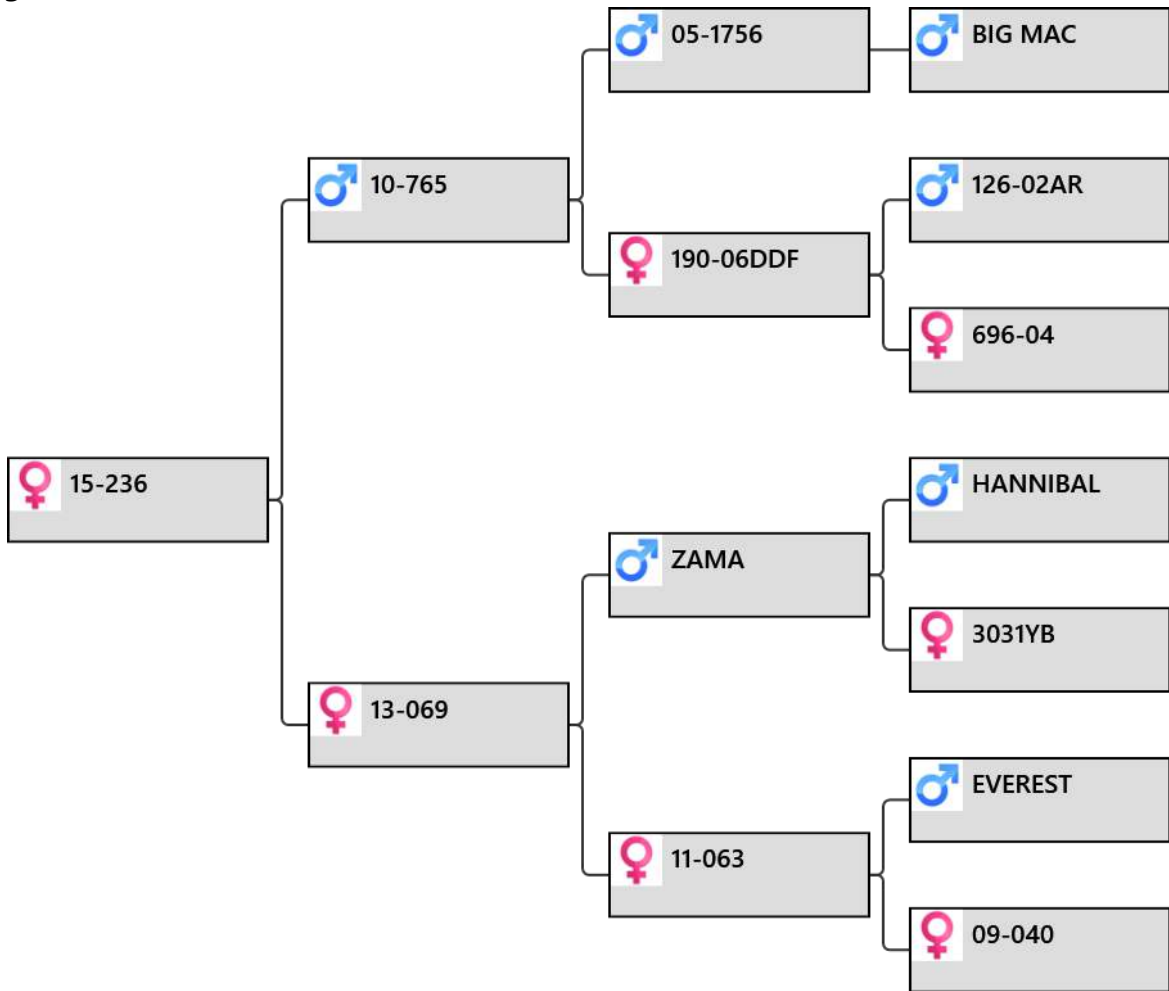

Biography:

236-15 by 765-10 7.8kg @ 2yr
 69-13 first fawner by supreme champion Zama.
 63-11 Everest daughter who has a son cutting 4.8kg @ 2yr
 40-09 a full sister to 81-06 18.44kg SS @ 10yr

Sale weight: Price: Buyer:

lot # 87 – Yearling hind



Altrive Red Deer
performance recorded since 1985
Yearling Hind sale 2017

Animal: **15-239**

Birthdate: 2015

Weigh Date	Weight
5/04/2016	50 kg
28/11/2016	81 kg

Pedigree:

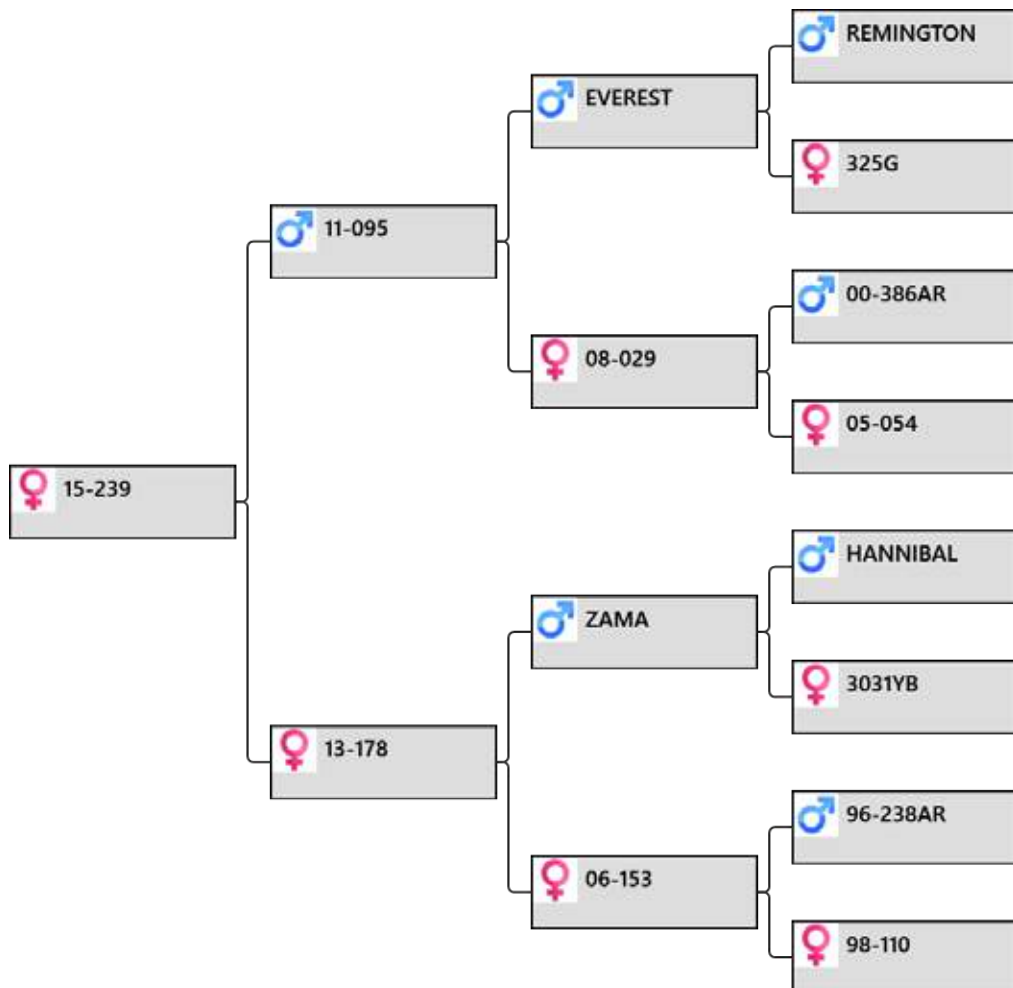

Biography:

239-10 by 95 -11 10.65 kg @ 5yr.
178-13 a first fawner by Zama 12.25kg SA
153-06 a son cutting 4.35kg @ 2yr
110-98 a son sold as a trophy

Sale weight:

Price:

Buyer:



lot # 88 – Yearling hind

 <p>performance recorded since 1985</p> <p>Yearling Hind sale 2017</p>	<p>Animal: 15-248</p> <hr/> <p>Birthdate: 2015</p> <table border="1"> <thead> <tr> <th>Weigh Date</th> <th>Weight</th> </tr> </thead> <tbody> <tr> <td>5/04/2016</td> <td>59 kg</td> </tr> <tr> <td>28/11/2016</td> <td>82 kg</td> </tr> </tbody> </table>	Weigh Date	Weight	5/04/2016	59 kg	28/11/2016	82 kg
	Weigh Date	Weight					
5/04/2016	59 kg						
28/11/2016	82 kg						

Pedigree:

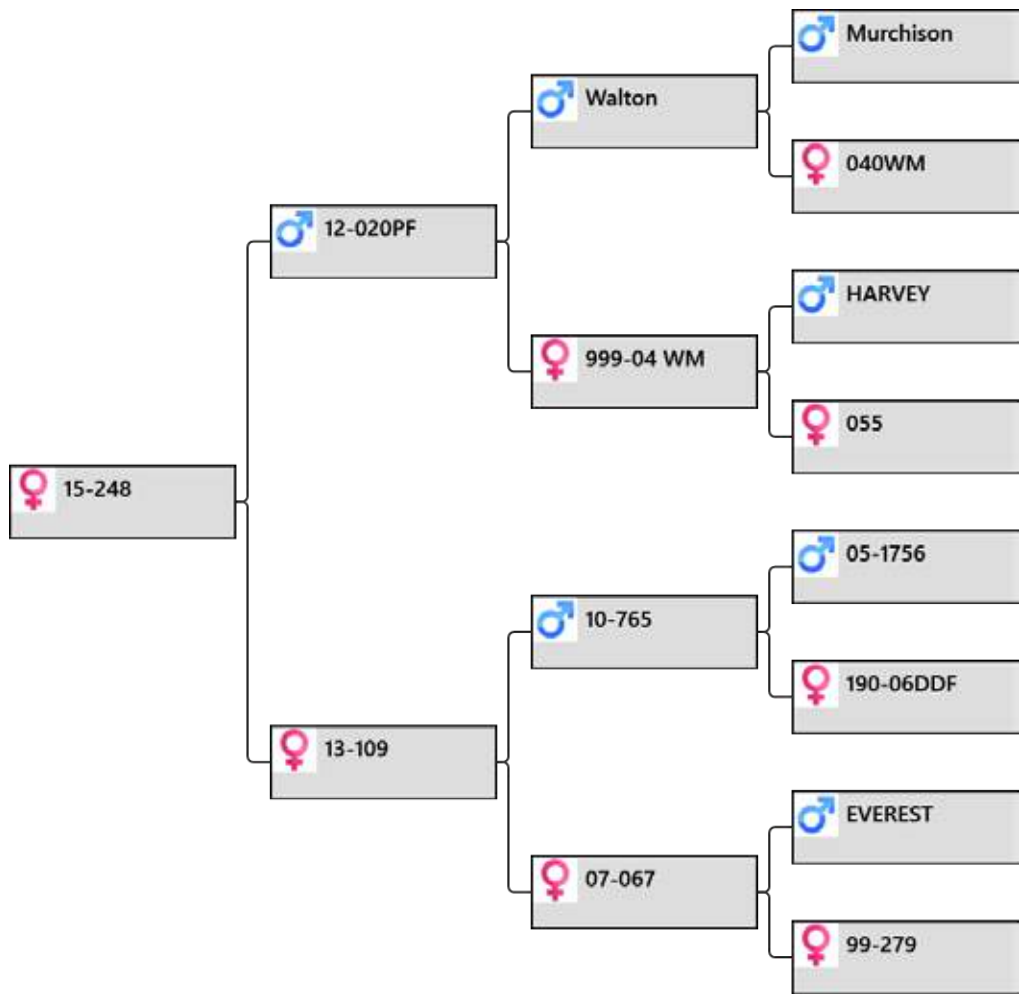

Biography:

248-15 by PF 20-12 8kg @ 4yr

109 13 a first fawner

67-07 an Everest daughter who has produced a son cutting 4.0kg @ 2yr

279-99 from dam line of Victrix.

Sale weight:

Price:

Buyer:

lot # 89 – Yearling hind



Altrive Red Deer
performance recorded since 1985
Yearling Hind sale 2017

Animal: **15-249**

Birthdate: 2015

Weigh Date	Weight
5/04/2016	63 kg
28/11/2016	93 kg

Pedigree:

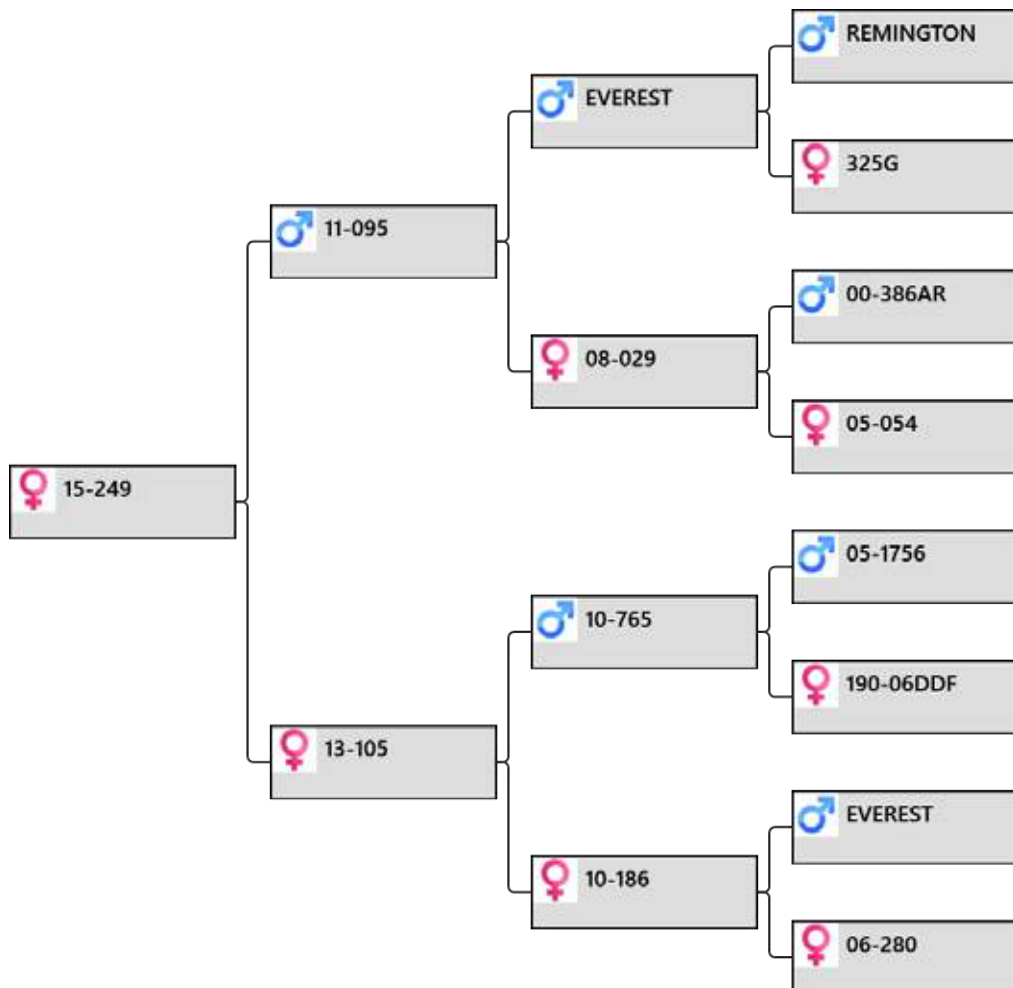

Biography:

249-15 by 95-11 10.65kg 5yr

105-13 a first fawner

186-10 an Everest daughter with a son cutting 4.6kg@ 2yr

280-06 sons cutting 4.25 and 3.95kg @ 2yr with one sold 2012 for \$3,000.

Sale weight:

Price:

Buyer:



lot # 90 – Yearling hind

 <p>performance recorded since 1985</p> <p>Yearling Hind sale 2017</p>	<p>Animal: 15-280</p> <hr/> <p>Birthdate: 2015</p> <table border="1"> <thead> <tr> <th>Weigh Date</th> <th>Weight</th> </tr> </thead> <tbody> <tr> <td>5/04/2016</td> <td>56 kg</td> </tr> <tr> <td>28/11/2016</td> <td>77 kg</td> </tr> </tbody> </table>	Weigh Date	Weight	5/04/2016	56 kg	28/11/2016	77 kg
	Weigh Date	Weight					
5/04/2016	56 kg						
28/11/2016	77 kg						

Pedigree:

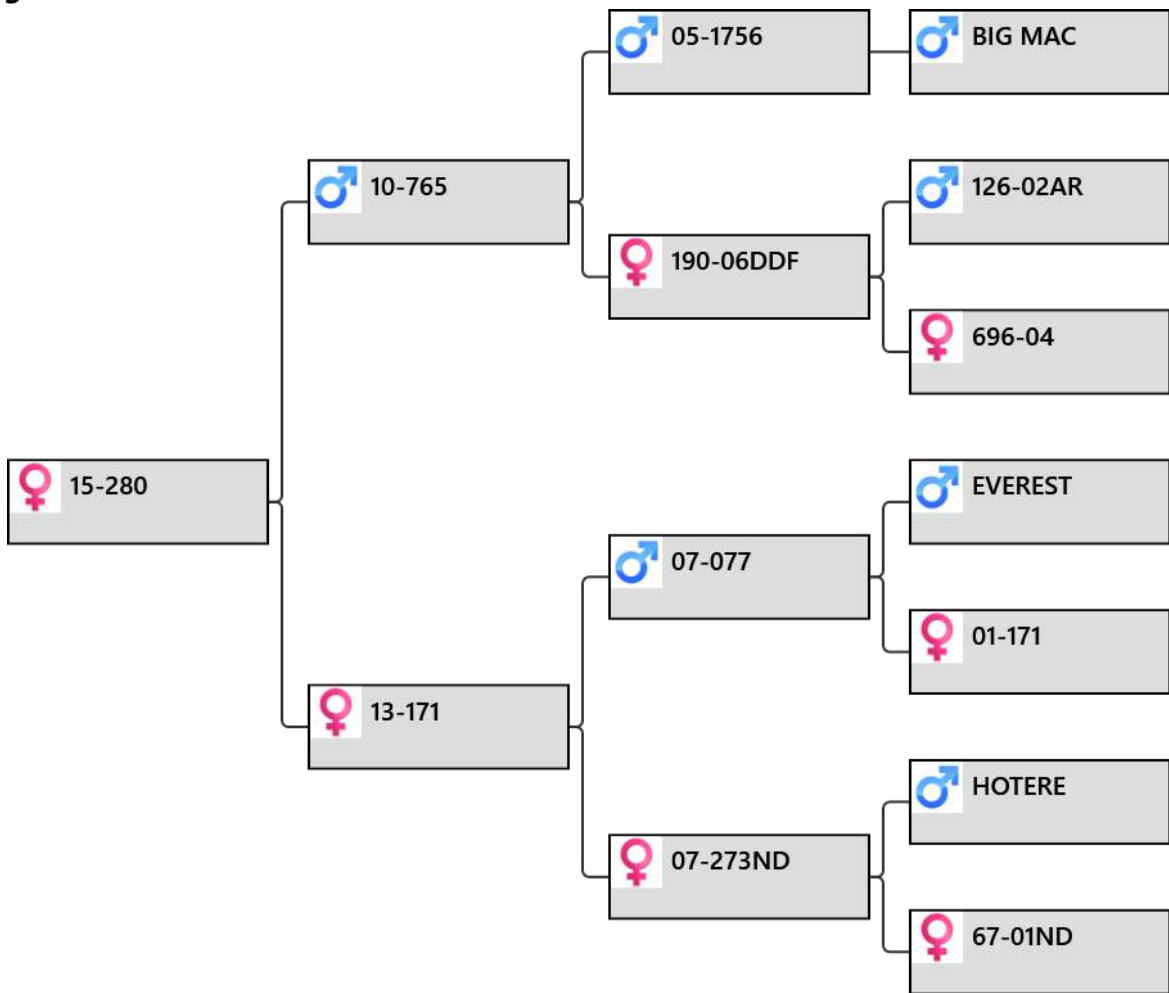

Biography:

280-15 by 765-10 7.8kg @ 2yr.
 171-13 a first fawner by 77-07 10kg @ 6yr
 273-07 a hind purchased from Netherdale.

Sale weight: _____ Price: _____ Buyer: _____

lot # 91 – Yearling hind Replacement hind



Animal: **15-282**

Birthdate: 2015

Weigh Date	Weight
5/04/2016	58 kg
28/11/2016	83 kg

Pedigree:

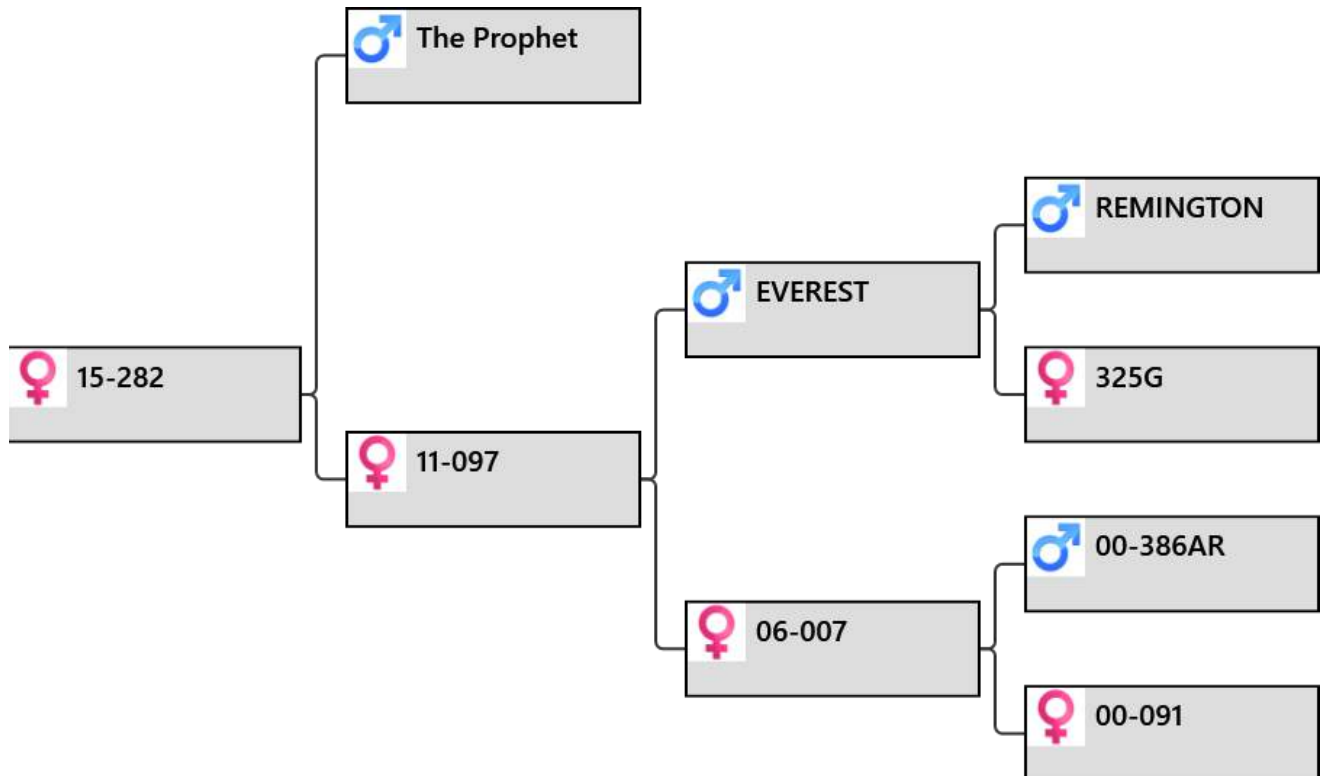

Biography:

282-15 by The Prophet 10.6kg
 97-11 by Everest 12.25kg SA
 7-06 a son sold 2013 \$6,500

Sale weight:

Price:

Buyer:



lot # 92 – Yearling hind Replacement hind

 <p>Altrive Red Deer performance recorded since 1985 Yearling Hind sale 2017</p>	<p>Animal: 15-297</p> <hr/> <p>Birthdate: 2015</p> <table border="1"> <thead> <tr> <th>Weigh Date</th> <th>Weight</th> </tr> </thead> <tbody> <tr> <td>5/04/2016</td> <td>59 kg</td> </tr> <tr> <td>28/11/2016</td> <td>91 kg</td> </tr> </tbody> </table>	Weigh Date	Weight	5/04/2016	59 kg	28/11/2016	91 kg
	Weigh Date	Weight					
5/04/2016	59 kg						
28/11/2016	91 kg						

Pedigree:

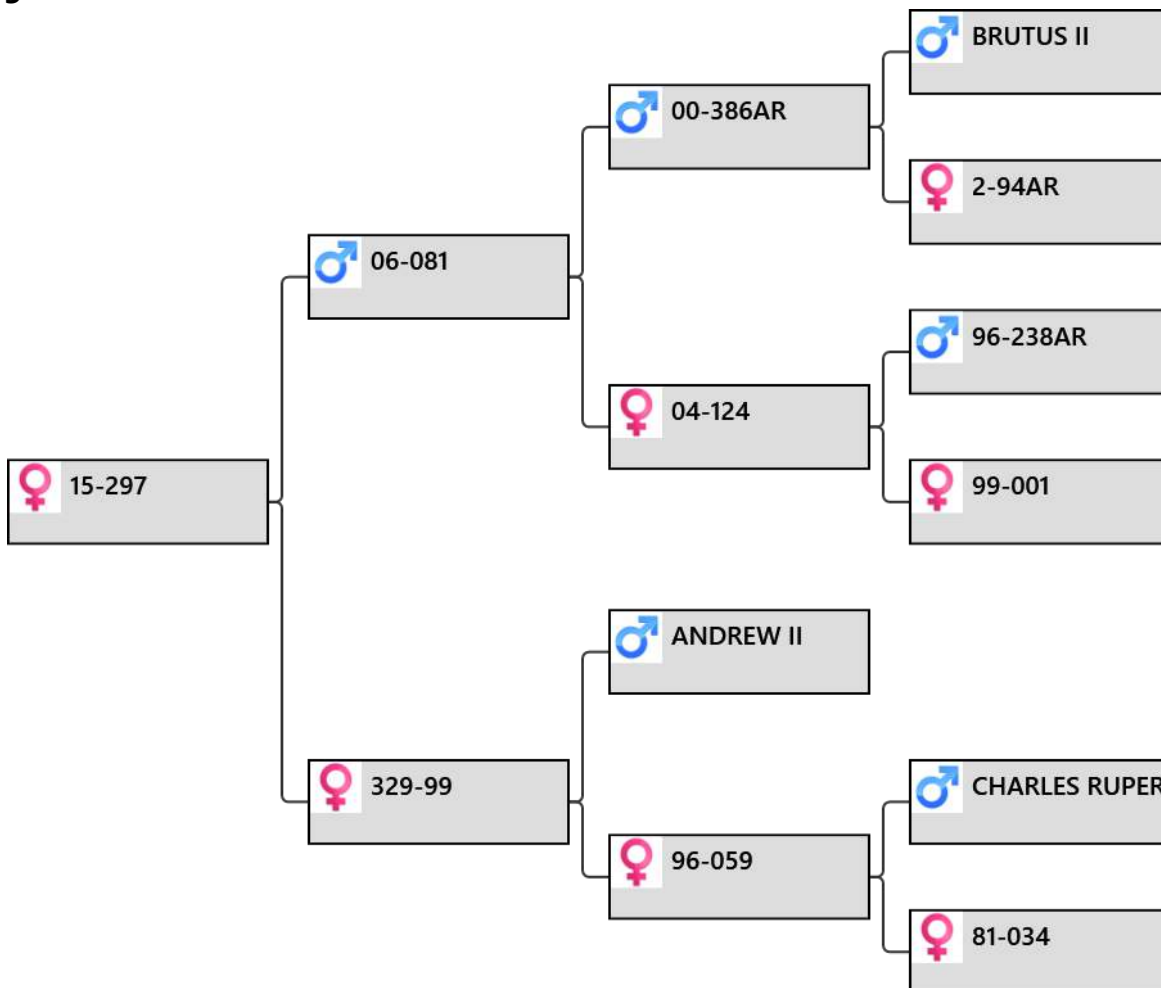

Biography:

297-15 by 81-06 11.8kgSA 7yr
 329-99 purchased from John Bates and produced a son sold 2015 \$6,800
 59-96 is the dam of David 11kg SA.
 34-81 dam of Lancelot and Andrew II

Sale weight: Price: Buyer:

lot # 93 – Yearling hind Replacement hind



Animal: **15-298**

Birthdate: 2015

Weigh Date	Weight
5/04/2016	42 kg
28/11/2016	74 kg

Pedigree:

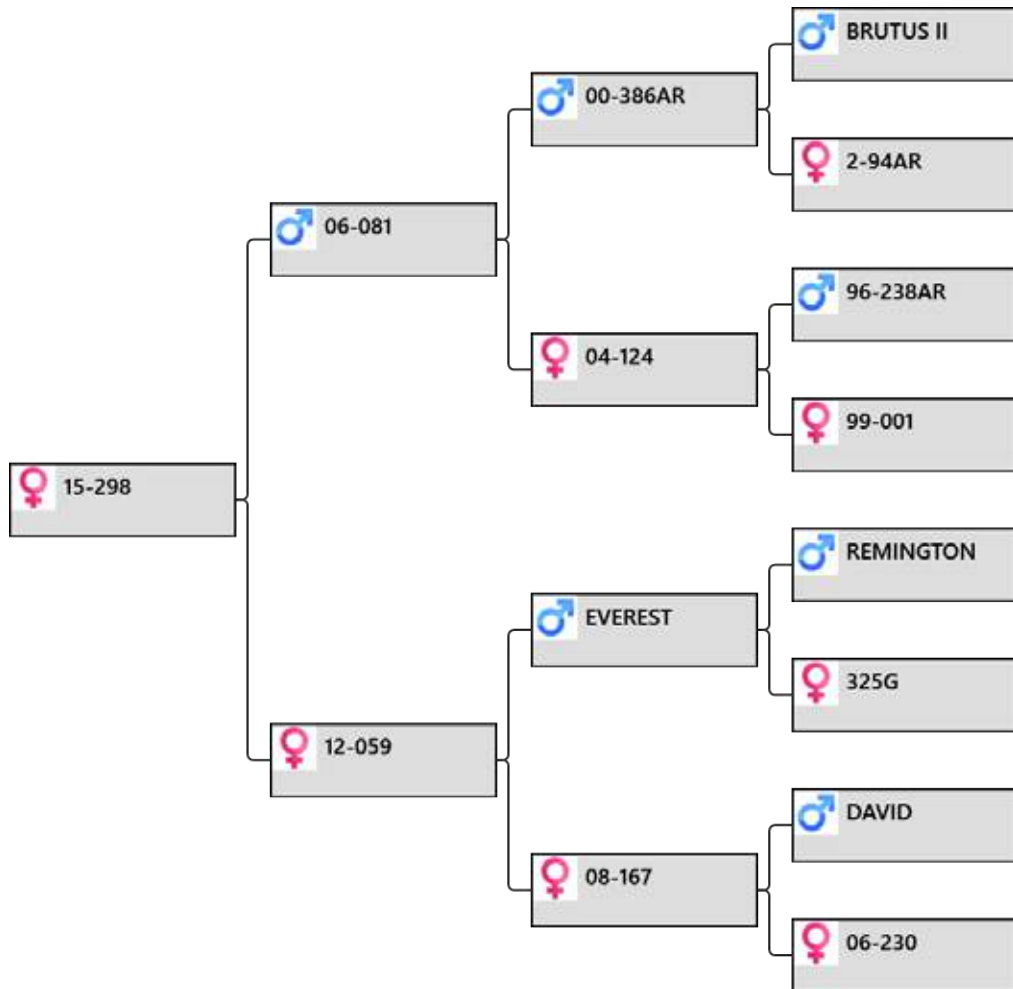

Biography:

298-15 by 81-06 11.8kg @ 7yr
 59-12 an Everest daughter with no sons so far.
 167-08 by David 11kg SA no sons
 230-06 sons cutting 4.0kg and 3.65kg @ 2yr

Sale weight:

Price:

Buyer:

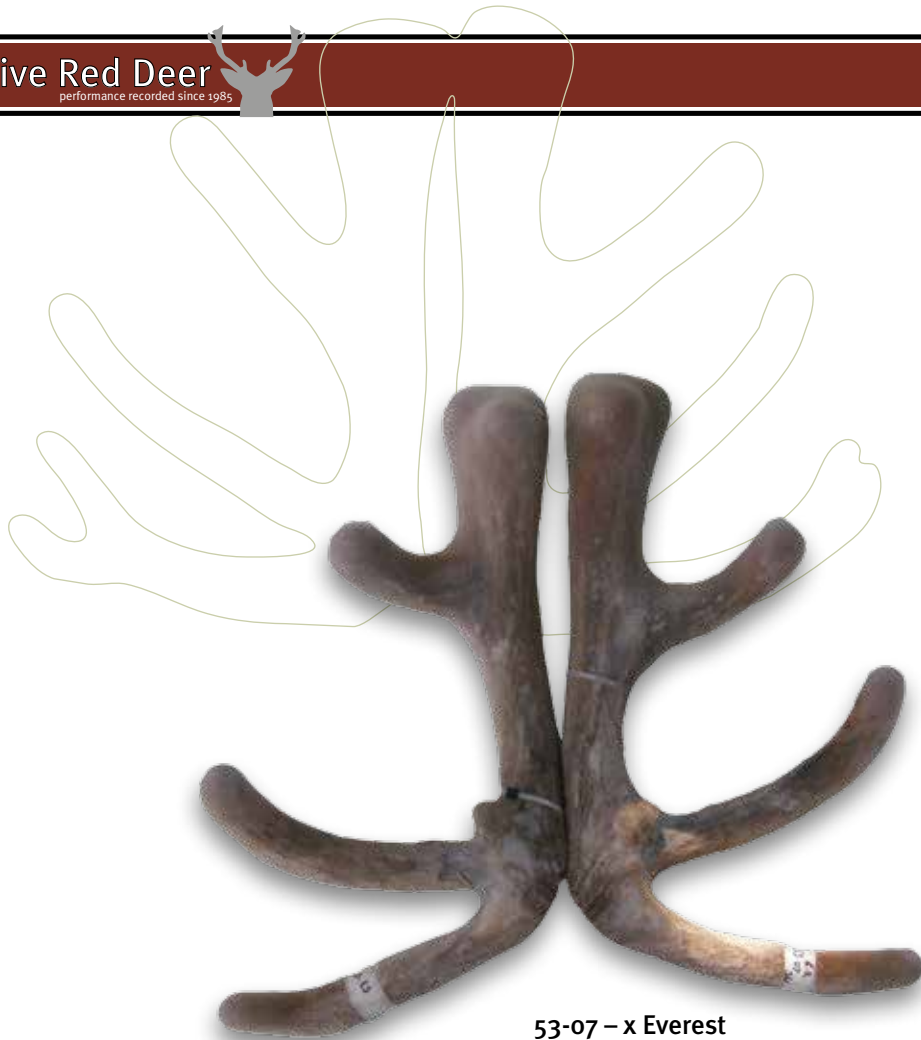

53-07 – x Everest
6.2kg 2yr National Champion

53-07 – x Everest - Sold to Joe Crowley, Tower Farms as a two year old and was National 2yr Champion.

Now called Za Co Zee, he is the sire of Joseph; 14kg and Open 2016 winner.